

# THE TUBE REBRANDING RACKET

# RADIO & TELEVISION NEWS

JULY

1956

35 CENTS

in U. S. and Canada

*World's Leading Electronics Magazine*

## IN THIS ISSUE

PORTABLE TV

BASS REFLEX—  
DESIGN OR ACCIDENT

TRANSISTORIZED  
GUITAR AMPLIFIER

NEW TECHNIQUES FOR  
REPAIRING PORTABLE SETS

A PORTABLE  
ULTRASONIC PROTECTION  
SYSTEM

NEW SINGLE-GUN COLOR TUBE

COMMERCIAL ASPECTS OF  
SINGLE-SIDEBAND

KEEP YOUR SCOPE OPERATING

A 20-WATT AMPLIFIER SYSTEM

DOING IT THE EASY WAY ▶  
(See Page 38)



X-74-3367-67  
SAMUEL TABSHY  
6727 N YALE ST  
PORTLAND 3 OREG



# Service Dealers!

## FOR YOU

# From Your Raytheon TUBE DISTRIBUTOR

*(ask for them!)*

These and many, many other valuable sales and shop aids are available to you through your Raytheon Tube Distributor. Many items are free and the rest are priced well below normal cost. All of them are specially designed to help you stimulate sales and increase service business volume, and to help you work more efficiently and effectively.

The Raytheon Sales Promotion Booklet is bursting with a magnificent collection of wonderful sales helps.

Ask your Raytheon Tube Distributor for a free copy or write to Department "A", Raytheon Mfg. Co., Receiving and Cathode Ray Tube Operations, Newton 58, Massachusetts.



PHONE CALL REGISTER



HEAT-ROTOR SIGN



JOB REPAIR TAGS



BUMPATEL SIGN



DISPLAYS



TUBE AND TOOL CARRYING CASES



SHOP COATS AND JACKETS



DISPENS-AN-AD AND BOOK MATCHES



ILLUMINATED OUTDOOR SIGNS



STATIONERY



QUICK ATTACHABLE COLOR SPOT SIGNS



# RAYTHEON MANUFACTURING COMPANY

Receiving and Cathode Ray Tube Operations

Newton, Mass. • Chicago, Ill. • Atlanta, Ga. • Los Angeles, Calif.



Excellence in Electronics

# You Practice **SERVICING** with Kits I Send You



Nothing takes the place of PRACTICAL EXPERIENCE. That's why NRI training is based on LEARNING BY DOING. You use parts I send to build many circuits common to Radio and Television. With my Servicing Course you build the modern Radio shown at left. You build a Multitester and use it to help make \$10, \$15 a week fixing sets in spare time while training. All equipment is yours to keep. Coupon below will bring book of important facts. It shows other equipment you build.

# You Practice **BROADCASTING** with Kits I Send You



As part of my Communications Course I send you parts to build low-power Broadcasting Transmitter at left. Use it to get practical experience. You put this station "on the air" . . . perform procedures demanded of broadcasting station operators. An FCC Commercial Operator's License can be your ticket to a bright future. My Communications Course trains you to get your license. Mail coupon. Book shows other equipment you build for practical experience.

# I Will Train You at Home in Spare Time to be a **RADIO-TELEVISION** Technician



## TELEVISION

### Making Jobs, Prosperity

25 million homes have Television sets now. Thousands more sold every week. Trained men needed to make, install, service TV sets. About 200 television stations on the air. Hundreds more being built. Good job opportunities here for qualified technicians, operators, etc.



## America's Fast Growing Industry Offers You Good Pay, Success

Training PLUS opportunity is the PERFECT COMBINATION for job security, advancement. When times are good, the trained man makes the BETTER PAY, gets PROMOTED. When jobs are scarce, the trained man enjoys GREATER SECURITY. NRI training can help assure you and your family more of the better things of life. Radio is bigger than ever with over 3,000 broadcasting stations and more than 115 MILLION sets in use, and Television is moving ahead fast.

## N.R.I. Training Leads to Good Jobs Like These

### I TRAINED THESE MEN



"I have progressed very rapidly. My present position is Studio Supervisor with KEDD Television, Wichita."—Elmer Frewaldt, 3026 Stadium, Wichita, Kans.

"Fix sets part time in my shop. Made about \$500 first three months of the year. Could have more but this is about all I can handle."—Frank Borer, Lorain, Ohio.



"I've come a long way in Radio and Television since graduating. Have my own business on Main Street."—Joe Travers, Asbury Park, New Jersey.

"I didn't know a thing about Radio. Now have a good job as Studio Engineer at KMMJ."—Bill Delzell, Central City, Nebraska.



**BROADCASTING:** Chief Technician, Chief Operator, Power Monitor, Recording Operator, Remote Control Operator. **SERVICING:** Home and Auto Radios, Television Receivers, FM Radios. **P.A. Systems.** **IN RADIO PLANTS:** Design Assistant, Technician, Tester, Serviceman, Service Manager. **SHIP AND HARBOR RADIO:** Chief Operator, Radio-Telephone Operator. **GOVERNMENT RADIO:** Operator in Army, Navy, Marine Corps, Forestry Service Dispatcher, Airways Radio Operator. **AVIATION RADIO:** Transmitter Technician, Receiver Technician, Airport Transmitter Operator. **TELEVISION:** Pick-up Operator, Television Technician, Remote Control Operator.

## Start Soon to Make \$10, \$15 a Week Extra Fixing Sets

My training is practical, complete; is backed by 40 years of success training men at home. My well-illustrated lessons give you basic principles you need and my skillfully developed kits of parts "bring to life" things you learn from the lessons. I start sending you special booklets the day you enroll, that show you how to fix sets. Multitester you build with my parts helps you discover and correct set troubles, helps you make money fixing neighbors' sets in spare time while training. Many make \$10, \$15 a week extra this way.

## Mail Coupon — Find Out What Radio-Television Offer You

Act now to get more of the good things of life. I send actual lesson to prove NRI home training is practical, thorough. My 64-page book "How to be a Success in Radio-Television" shows what my graduates are doing and earning. It gives important facts about your opportunities in Radio-Television. Take NRI training for as little as \$5 a month. Many graduates make more than the total cost of my training in two weeks. Mail coupon now to: J. E. SMITH, President, Dept. 6GE, National Radio Institute, Washington 9, D. C. Our 40th year.

**AVAILABLE to all qualified VETERANS UNDER G. I. BILLS**

## Good for Both - FREE

MR. J. E. SMITH, President, Dept. 6GE National Radio Institute, Washington 9, D. C. Mail me Sample Lesson and 64-page Book, FREE (No salesman will call. Please write plainly.)

Name ..... Age .....

Address .....

City ..... Zone .... State .....

**VETS** write in date of discharge .....

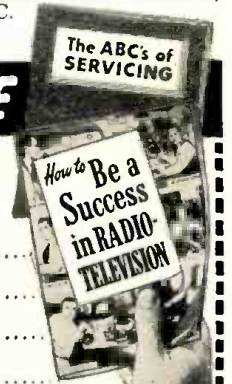

## Mail Today-Tested Way to Better Pay

**RADIO & TELEVISION NEWS** is published monthly by Ziff-Davis Publishing Company, William B. Ziff, Chairman of the Board (1946-1953), at 64 E. Lake St., Chicago 1, Ill. Entered as second-class matter July 21, 1948, at the Post Office, Chicago, Ill., under the act of March 3, 1879. Authorized by Post Office Department, Ottawa, Canada, as second-class matter. **SUBSCRIPTION RATES:** Radio & Television News—one year U. S. and possessions, and Canada \$4.00; Pan-American Union countries \$4.50; all other foreign countries \$5.00.

**Publisher**  
**OLIVER READ, D.Sc., W1ETI**  
**Editor**  
**WM. A. STOCKLIN, B. S.**  
**Technical Editor**  
**MILTON S. SNITZER**  
**Service Editor**  
**CHARLES TEPFER**  
**Associate Editor**  
**P. B. HOEFER**  
**Assistant Editor**  
**J. JUSTER**  
**Television Consultant**  
**WALTER H. BUCHSBAUM**  
**Art Editor**  
**FRANK SAYLES**  
**Art and Drafting Dept.**  
**J. A. GOLANEK**  
**W. K. VAHSING**  
**JAMES A. ROTH**  
**Advertising Director**  
**L. L. OSTEN**  
**Advertising Manager**  
**MURRAY GOLDMAN**  
**Midwest Adv. Manager**  
**JOHN A. RONAN, JR.**  
**Western Adv. Manager**  
**JOHN E. PAYNE**



*First in radio-  
television-audio-electronics*

Average Net Paid Circulation 229,357

Radio News Trademark Reg. U. S. Pat. Office • Television News Trademark Reg. U. S. Pat. Office.

**CONTENTS**

**JULY, 1956**

**EDITORIAL—INDUSTRY NEWS**

For the Record..... *O. Read* 8  
Spot Radio News..... *Washington Correspondent* 14  
New TV Grants Since Freeze Lift..... 14  
New Designs in Tube Envelopes..... 42  
Sun-Powered Radio ..... 49  
TV Programs on Magnetic Tape..... 92

**HIGH FIDELITY AND AUDIO**

Transistorized Guitar Amplifier..... *Paul Penfield, Jr.* 43  
Bass Reflex—Design or Accident..... *Robert C. Sanford* 46  
Certified Record Revue..... *Bert Whyte* 58  
Realistic High Fidelity—The Single-Cone  
Loudspeaker (Part 4)..... *H. A. Hartley* 59  
A 20-Watt Amplifier System..... 64  
New Hi-Fi—Audio Equipment..... 82

**SERVICING**

**Television-Radio**

Portable TV..... *Walter H. Buchsbaum* 35  
The Tube Racket..... 40  
New Techniques for Repairing Portable Sets..... *James A. McRoberts* 50  
A New Single-Gun Color Tube..... 62  
Mac's Service Shop..... *John T. Frye* 70  
TV Receivers Now Use Selenium Diodes... *T. P. Clements & Hugh S. Wyeth* 98  
Antenna News ..... 118  
Radio-TV Service Industry News..... 130

**Test Equipment**

Keep Your Scope Operating..... *Sol Heller & Peter Orne* 66  
Crystal Marker for TV Alignment..... *Guy Dexter* 80  
New Tube Tester Data ..... 108  
Using Your Test Equipment..... *Mel Byron* 138

**AMATEUR AND COMMUNICATIONS**

Doing It the Easy Way..... *Joseph Steinmetz, W4YI* 38  
Commercial Aspects of Single-Sideband (Part 3)..... *Jack N. Brown* 55

**ELECTRONIC THEORY AND CONSTRUCTION**

A Portable Ultrasonic Protection System..... *Louis E. Garner, Jr.* 52  
A New Radiation Counter..... 88  
“p-n-p”—“n-p-n” Oscillators..... *E. G. Louis* 105  
Electronic Latching Relay..... *Rufus P. Turner* 123

**DEPARTMENTS**

Within the Industry..... 26      Manufacturers' Literature ..... 124  
What's New in Radio..... 100      Sales Aids ..... 136  
Technical Books..... 140



COVER PHOTO: Part of the “dream” antenna setup of W4YI and W4TFP, Sarasota, Florida. The Steinmetz “team” have their three Telrex beams mounted atop 50-foot mast. For details see article, page 38. (Ektachrome by Joseph Steinmetz)

**ZIFF-DAVIS PUBLISHING COMPANY**

**President**  
**B. G. DAVIS**  
**Vice-Presidents**  
**H. J. MORGANROTH**  
**M. MICHAELSON**  
**M. H. FROELICH**  
**Secretary-Treasurer**  
**G. E. CARNEY**

**BRANCH OFFICES**

CHICAGO [11]  
64 E. Lake St., AN 3-5200  
LOS ANGELES [14]  
215 W. 7th St. (Room 412) TRINITY 8043



**ZIFF-DAVIS PUBLISHING COMPANY**  
**WILLIAM B. ZIFF (1898-1953) FOUNDER**  
Editorial and Executive Offices  
366 Madison Ave., New York 17, N. Y.  
**VOLUME 56 • NUMBER 1**



Member  
Audit Bureau of  
Circulations

© 1956 by Ziff-Davis Publishing Company. All rights reserved.

**SUBSCRIPTION SERVICE:** All communications concerning subscriptions should be addressed to Circulation Dept., 64 E. Lake St., Chicago 1, Ill. Subscribers should allow at least four weeks for change of address. Include your old address as well as new—enclosing, if possible, an address label from a recent issue of this magazine.

**CONTRIBUTIONS:** Contributors are advised to retain a copy of their manuscripts and illustrations. Contributions should be mailed to the New York Editorial Office and must be accompanied by return postage. Contributions will be handled with reasonable care, but this magazine assumes no responsibility for their safety. Any copy accepted is subject to whatever adaptations and revisions are necessary to meet the requirements of this publication. Payment covers all author's, contributor's, and contestant's rights, title, and interest in and to the material accepted and will be made at our current rates upon acceptance. All photos and drawings will be considered as part of the material purchased.

Prepare Now... in spare time at Home... for a New,

PROFITABLE, INTERESTING FUTURE  
 in **AUTOMATION**  
 ELECTRONICS  
**TELEVISION**  
 RADIO-ELECTRONICS



RADIO CHIEF OF ILE DE FRANCE  
 FRENCH LUXURY LINER PRAISES D T I

Radio Chief—Jean Desmas Says:

"Your Training Organization in Chicago is known not only throughout Europe, but also in many parts of the world as one of America's finest Television, Radio and Electronics training centers."



**JACK DEMPSEY**

Former World's Heavyweight Champion  
 TELLS WHY HE'S PROUD  
 TO BE WITH **D T I**

- I have been greatly impressed with D T I's wonderful spirit of friendliness and sincere determination to help its students make good in Television-Radio-Electronics.
- I admire its remarkable 25 year record of helping men build brighter futures.
- I also admire the business policy of its management and the thoroughness of its large faculty of instructors.
- Never have I heard young men praise a school as enthusiastically as do the students and graduates of D T I. They are its best boosters.

**Prepare At Home Or In Our Chicago Laboratory!**

See for yourself how readily you may prepare at home, or in our modern Chicago laboratories, for a good job or business of your own in one of America's most promising, fast-growing fields—TELEVISION-RADIO-ELECTRONICS.

If you train at home you get (1) the use of a 16-mm. movie projector and 16 reels of animated movies to help you learn important points faster... easier, (2) modern, well illustrated lessons and (3) sixteen shipments of electronic parts enabling you to get valuable practical experience from over 300 projects—including building and keeping the electronic equipment shown below. And upon completing training, you have the optional privilege of building and keeping a big 21 INCH TV Set. (D T I offers another home training in Television-Radio-Electronics, but without the TV set.) Get the full story. Mail coupon today!

**LAUD D T I'S HOME MOVIES IN CONGRESS**

D T I's remarkable home training benefit of visual training MOVIES has been praised from the floor of the House of Representatives in Washington, D.C. and recorded in the Congressional Record.



If subject to military service, the information we have for you should prove very helpful. Mail coupon today.

"One of America's Foremost Electronics Training Centers"

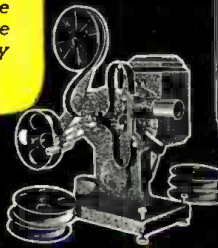

HOME MOVIES



VACUUM TUBE VOLTMETER



OSCILLOSCOPE



Build and keep this BIG DTI Engineered TV set—easily converted to U.H.F. (DTI offers another home training, but without the TV set.)

**89 WAYS TO EARN MONEY IN TELEVISION RADIO ELECTRONICS**

MEMBER OF NATIONAL HOME STUDY COUNCIL

**MAIL COUPON TODAY!**

DeVRY TECHNICAL INSTITUTE  
 4141 BELMONT AVE., CHICAGO 41, ILL.

Dept. RN-7-M

I would like your valuable information-packed publication showing how I may get started toward a good job or my own business in Television-Radio-Electronics.

Name \_\_\_\_\_ Age \_\_\_\_\_  
 (PLEASE PRINT)  
 Street \_\_\_\_\_ Apt. \_\_\_\_\_  
 City \_\_\_\_\_ Zone \_\_\_\_\_ State \_\_\_\_\_  
 1005 D T I's Training is Available in Canada

**DeVRY TECHNICAL INSTITUTE**

CHICAGO 41, ILLINOIS

FORMERLY

**DeFOREST'S TRAINING, INC.**



# HOW SPECIFIC DO YOU LIKE YOUR SPECS?

Amplifier specifications can be written many ways. In the first column the specifications of the Altec Lansing 340A amplifier are presented in the spectacular manner that has become popular for high fidelity products. Next to these amazing figures are the specifications of the 340A as published and guaranteed by Altec. It's easy to see that the Spectacular bears little resemblance to the complete Engineering Facts;

that useless data is given and necessary facts and figures are glossed over or omitted entirely. When you are comparing amplifiers don't be misled by comparing the Spectacular with the Engineering Facts. Both may be true but only the Engineering Facts give a true picture of performance. Altec Lansing specifications are always technically complete, a true engineering report of quality performance.

	340A	
	SPECTACULAR	ENGINEERING FACTS
<b>POWER</b> should be expressed in continuous watts (not instant peaks) over a stated frequency range with a specified maximum distortion, otherwise the rating can refer to an overly distorted output level or to a power peak at only one frequency.	100 watts (peak) 50 watts continuous at 2% distortion	35 watts continuous from 30 to 22,000 cycles with less than 0.5% distortion
<b>FREQUENCY RESPONSE</b> should be given at a stated power output since an amplifier's response curve can vary drastically with changing output powers.	within 1 db 5 - 100,000 cps	within 1 db 5 - 100,000 cps 0 to 5 watts output within 0.1 db 30 - 22,000 cps 0 to 35 watts output
<b>DISTORTION</b> varies with frequency and power output (see curve) and should be stated at full power over a specific range, otherwise it may refer to the lowest distortion point in the mid-range.	0.2% at 35 watts	less than 0.5% 30-22,000 cps at 35 watts less than 0.2% 30-22,000 cps at 5 watts
<b>INTERMODULATION</b> should be measured at full power using a low (under 45 cps) test frequency. Use of a higher frequency and a selected lesser power output results in an unrealistically low intermodulation figure.	0.5% at 15 watts 60 cps and 7 kc, 4:1 ratio	1.0% at 35 watts 40 cps and 2 kc, 4:1 ratio

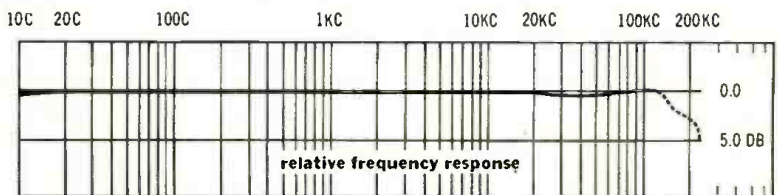
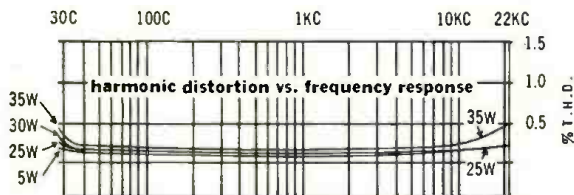

**340A**  
\$159.00

For Spectacular Specifications or Engineering Facts, the Altec 340A power amplifier is the quality choice. Ask your Altec Dealer to show you the 340A and the beautifully styled Altec 440B preamplifier. You'll find they are above comparison.

The Engineering Facts given above represent the minimum manufacturing standards for the 340A power amplifier. Every 340A is thoroughly tested and carries the Altec quality guarantee that it will meet or exceed these published specifications.

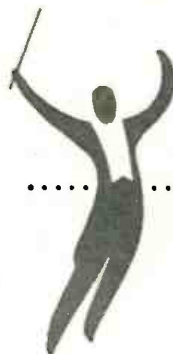

Dept. 7TM

9356 Santa Monica Blvd., Beverly Hills, Calif.  
161 Sixth Avenue, New York 13, N. Y.

RADIO & TELEVISION NEWS

# Learn to Service TV Sets— any make or model—Quickly

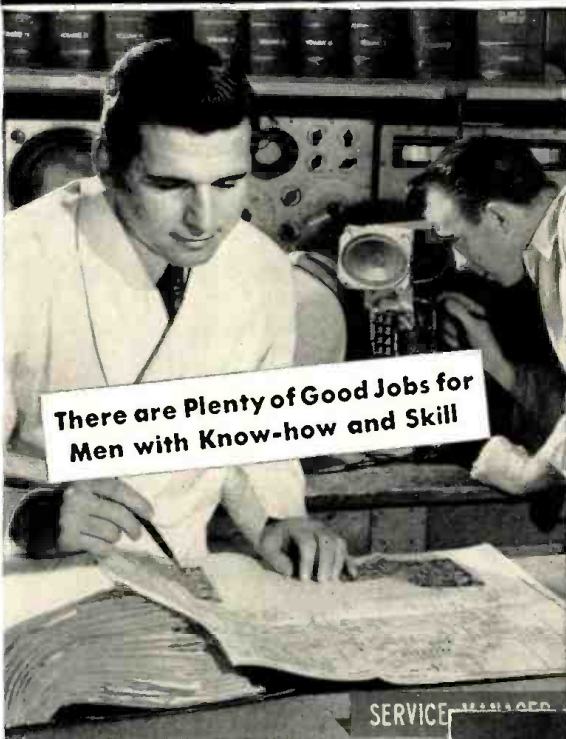

There are Plenty of Good Jobs for Men with Know-how and Skill

## New ALL PRACTICE Method trains you at home to become a Professional TV Serviceman

### You learn the time saving techniques, methods used by top TV Servicemen

This is 100% learn-by-doing, practical training. NRI supplies all necessary equipment, all tubes, including a 17-inch picture tube; and comprehensive manuals covering a thoroughly planned program of practice. You learn how experts diagnose TV receiver defects quickly. You easily learn the causes of defects—audio and video—and how to fix them accurately.

You get actual experience aligning TV receivers, isolating complaints from scope patterns, eliminating interference, using germanium crystals to rectify the TV picture signal, adjusting the ion trap and hundreds of other valuable Professional techniques.

### UHF and COLOR Create Growing Opportunities

To cash in on the present UHF and the coming COLOR TV boom you'll need the kind of knowledge and experience NRI's Course gives. You'll get practice installing front-end channel selector strips in modern UHF-VHF receivers. You learn UHF servicing problems and their solution. Mail the coupon now. Discover how NRI's new course in PROFESSIONAL TELEVISION SERVICING meets the needs of the man who wants to get ahead in TV Servicing.

### Not for Beginners

If you have some knowledge of Radio-TV fundamentals, or have had some Radio Shop experience or some Radio School training, this course IS FOR YOU. Mail coupon today. Address: National Radio Institute, Dept. 6GET, 16th and U Sts., N.W., Washington 9, D. C.

**MAIL NOW**

17" Picture Tube, Components for a TV Receiver, Scope, Signal Generator, HF Probe—all included in introductory price under \$200—Easy Terms

If you want to go places in TV servicing, you will act quickly to find out what you get, what you practice, what you learn and how NRI's new course in Professional Television Servicing will help you advance through better technical knowledge and training. See pictures of equipment supplied, read what you practice in book offered FREE to ambitious men with some knowledge of Radio or TV fundamentals. Find out about this ALL PRACTICE Professional TV Servicing Course now.

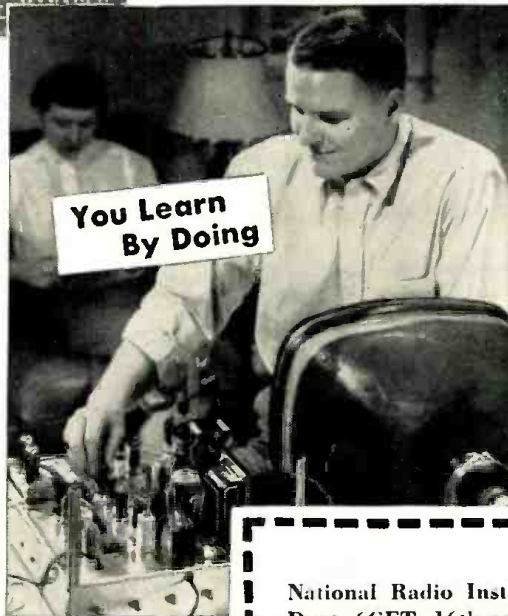

You Learn By Doing

## COUPON BRINGS IMPORTANT BOOK FREE

Get this book and judge for yourself how this course will further your ambition to reach the top in TV Servicing or help to build a more secure business of your own in TV. Many of tomorrow's top TV Servicemen . . . men who can service any make, any model, UHF, VHF or Color TV . . . will be graduates of this training. Mail the coupon now. There is no obligation.

HOW TO REACH THE TOP IN TV SERVICING

National Radio Institute  
Dept. 6GET, 16th and U Sts., N.W.  
Washington 9, D.C.

Please send my FREE copy of "How to Reach the Top in TV Servicing."  
I understand no salesman will call.

Name.....Age.....

Address.....

City.....Zone.....State.....

APPROVED MEMBER National Home Study Council.

**ACTUALLY  
THIS SMALL**



**NEW TV  
649  
LAVALIER  
DYNAMIC**

So small—so light—you hardly know it's there! Designed for concealment and mobility, the E-V 649 Miniature Lavalier Dynamic<sup>®</sup> Microphone has remarkably efficient pick-up. Response is smooth, peak-free, 70 to 13,000 cps. Output —62 db.\* Can be hung on neck cord close to chest for free use of hands; or used on desk stand or in the hand to meet varying program requirements. Extra-rugged for constant everyday use.

Omnidirectional. Pop-proof wire-mesh grille minimizes wind and breath blasts. Indestructible Acoustalloy diaphragm. Impedance 50 ohms, easily changed to 150 or 250 ohms.

\*Referred to .0002 dynes/cm<sup>2</sup>



High-tensile aluminum case finished in TV gray. Supplied with 30 ft. cable, neck cord assembly and belt clip. Model 649. List, \$115

Normal Trade Discount Applies

Available from E-V Authorized Distributors. Write for Bulletin N67

**Electro-Voice<sup>®</sup>**

ELECTRO-VOICE, INC. • BUCHANAN, MICHIGAN

*For the* **RECORD.**

**RADIO SHOWS THEN AND NOW**

I AM, at this moment, attending our 34th "Parts Show" in Chicago. Many changes have been noted since 1922 when, in this same metropolis, I entered the Leiter Building to visit "The Chicago Radio Show." My job, at the time, was to "service" Radiola, Fada, Grebe, Tuska and Westinghouse radio sets at the Central Electric Company.

The technique of "service" in those days consisted of either replacing a burned-out vacuum tube or a "B" battery. Commercial radio receivers were still something new. For several years the public had been building its own receivers from data published in RADIO & TELEVISION NEWS (then Radio News) and little "know-how" was required to diagnose the few ills that beset the radio receiver of that era. The only test instrument required was a low resistance voltmeter.

So-called "Radio Shows" were open to the general public for many years and at the one we attended in 1922, more than 20,000 individuals paid admission to witness the latest products of this industry. Primitive machines on display (considered marvelous when wireless first was demonstrated) recalled memories of the immortal Binnes and the ill-fated "Republic" match box and finger-ring receivers. There were plenty of radio cabinets of the Chippendale, Sheraton, and Queen Anne designs, also the Aeriola Grands. A limitless number of home-made receivers included the regenerative, Hertz, Neutrodynes, and a few sets recognized commercially as being produced by established manufacturers.

We recall vividly the displays of workmanship from high school students. Several wood-turning exhibits showed how variometer parts could be easily made from data supplied by this publication and from weekly "how to" radio projects in the newspapers. Contests were held for making the best radio novelty, the best loudspeaker, and the best regenerative detector and amplifier receiver designed to operate over a wavelength range of from 175 to 600 meters. Local music dealers participated in these early shows as well as a few manufacturers of sets and parts. Crystal detectors, loose couplers, variometers, and other components were displayed and the public was told how to make them. An open forum introduced the topic of present business and future business, fads, and the question of formation of a National Radio Jobbers Association.

Radio "bootleggers" were denounced and claims were made by a Boston concern to the effect that it was the

only licensed crystal detector maker in the country.

Several forums were held during the Show to discuss radio prices, deliveries, the maintenance of newspaper interest, dealers' service to customers (a very vital subject indeed, for such service was badly neglected), and an effective method of reaching the farmers. Other meetings were devoted to civic matters, connected with radio, on an industrial level.

Alexander Eisemann, President of the National Radio Chamber of Commerce, addressed the convention from New York City. He said that "quantities of radio apparatus are made to sell but not to use. Radio factories are springing up all over the country and thousands of manufacturers, without previous experience, are building what they call radio outfits. These are built in so-called radio laboratories, but just as being born in a stable does not make one a horse, much of this apparatus called radio-receiving outfits fails to receive."

Many of the early pioneers of radio and television are still alive and very active in our industry. Each year I look forward to the annual get-together of "Radio's Old Timers" and to recall the early days when our Annual Show was more of a public than an industry affair.

The electronics industry has grown so tremendously in recent years and merchandising methods have changed so radically that our annual Parts Show, due to space limitation, is now confined to the manufacturer, his representatives, and his distributors. Even with this limitation, our annual Show, to which the public is no longer admitted, dwarfs the early displays attended by the public.

Forecasts made in 1922 are indeed interesting to those of us who have grown up with this industry. It was stated at the Chicago Radio Show that "radio is fast becoming a part of American home life, and when a large percentage of American homes are fitted with radio outfits, a great public demand will have been created for broadcasting. This demand will make itself felt in a political manner and it is conceivable that Mayors and Governors may be elected because they gave the public better broadcasting than their predecessors."

To the above quotation we add the magic word "TV." We are about to witness, in 1956, the fruition of TV as the most influential dynamic force in the history of politics. It is made possible by the pioneer experimenters of yesterday. . . . . O. R.



# ALLIED'S 1956 value-packed 324-page CATALOG

FREE



the only **COMPLETE** catalog  
for everything in electronics

**FEATURING SUPER-VALUE knight-kits**

**BUY DIRECT AND SAVE!** Select from America's top quality equipment in precision-designed kit form—everything in build-your-own Test Instruments, Hi-Fi kits, Hobbyist kits, Ham Gear—easiest to build and you **SAVE MORE!**

**FEATURING EVERYTHING IN HI-FI**

Make your money-saving selections from the world's largest offerings of complete Hi-Fi music systems and components—all the quality lines available for immediate shipment from stock. Own the very best in Hi-Fi for less!

*World's Most Complete Stocks*

**Huge Listings of Parts, Tubes, Transistors, Tools, Books • TV Tubes, Antennas and Accessories • Test and Lab Instruments • P. A. Systems and Accessories • Recorders and Supplies • Amateur Gear • Specialized Industrial Electronic Equipment...**

Get every buying advantage at ALLIED: fastest shipment, expert personal help, lowest prices, assured satisfaction. Make your selections from our 324-page 1956 Catalog packed with the world's largest selection of quality electronic equipment.

send for the  
leading electronic  
supply guide

FREE

**EASY-PAY TERMS**

Use our liberal Easy Payment Plan—only 10% down, 12 months to pay—no carrying charges if you pay in 60 days. Available on all orders over \$45, including Hi-Fi, P.A., Kits, Recorders, Test Instruments, Amateur Gear, etc.

*Our 35th year*

**ALLIED RADIO**

World's Largest Electronic Supply House



ALLIED RADIO CORP., Dept. 1-G-6  
100 N. Western Ave., Chicago 80, Ill.

Send FREE 324-Page 1956 ALLIED Catalog.

Name \_\_\_\_\_

Address \_\_\_\_\_

City \_\_\_\_\_ Zone \_\_\_\_\_ State \_\_\_\_\_

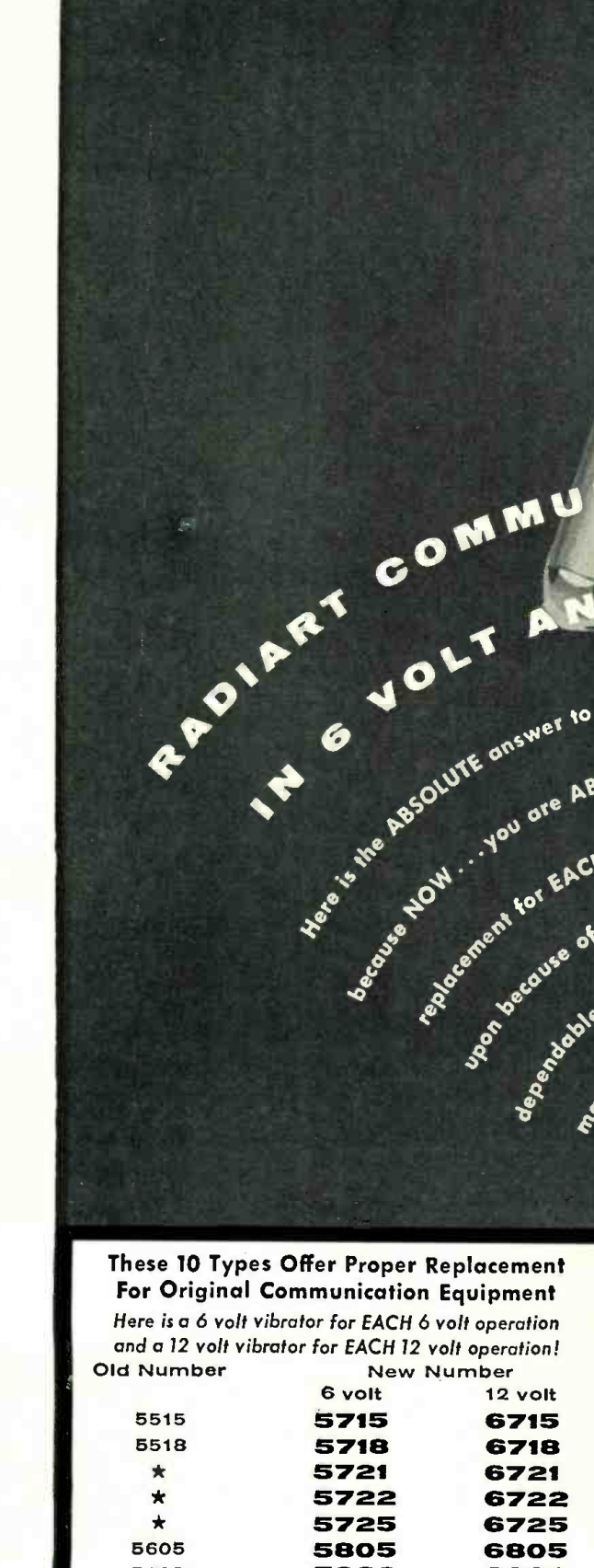

# RADIART COMMUNICATION VIBRATORS IN 6 VOLT AND 12 VOLT SERIES

Here is the ABSOLUTE answer to every communication vibrator replacement...  
 because NOW... you are ABSOLUTELY CERTAIN of the proper vibrator  
 replacement for EACH original type! And QUALITY you can depend  
 upon because of superior engineering... long lasting  
 dependable service because of quality controlled  
 manufacture which means MORE  
 performance hours per dollar!

## These 10 Types Offer Proper Replacement For Original Communication Equipment

Here is a 6 volt vibrator for EACH 6 volt operation  
and a 12 volt vibrator for EACH 12 volt operation!

Old Number	New Number	
	6 volt	12 volt
5515	<b>5715</b>	<b>6715</b>
5518	<b>5718</b>	<b>6718</b>
★	<b>5721</b>	<b>6721</b>
★	<b>5722</b>	<b>6722</b>
★	<b>5725</b>	<b>6725</b>
5605	<b>5805</b>	<b>6805</b>
5620	<b>5820</b>	<b>6820</b>
5621	<b>5821</b>	<b>6821</b>
5622	<b>5822</b>	<b>6822</b>
★	<b>5824</b>	<b>6824</b>



THE **RADIART** CORPORATION  
CLEVELAND 13, OHIO

VIBRATORS • AUTO AERIALS • TV ANTENNAS  
ROTORS • POWER SUPPLIES

Six months from today

Which Will You Hold?

this-

or this

COMMERCIAL  
FCC  
LICENSE

LICENSE  
EXAM  
FAILED

Add Technical Training  
To Your Practical Experience -  
**GET YOUR FCC LICENSE  
IN A HURRY!**

Then use our Amazingly Effective  
**JOB-FINDING SERVICE**

Money-Making  
FCC  
Commercial  
Radio Operator  
LICENSE  
Information

An FCC License Can Be  
Your Guarantee of Success  
in Electronics

Get This  
Valuable Booklet  
**FREE!**

● TELLS HOW -

Here Is Your  
GUARANTEE

If you fail to pass your Commercial License exam after completing our course, we guarantee to continue your training without additional cost of any kind until you successfully obtain your Commercial License.

**WE GUARANTEE**  
TO TRAIN AND COACH YOU  
AT HOME IN  
SPARE TIME UNTIL YOU GET  
**YOUR FCC LICENSE**

If you have had any practical experience—amateur, Army, Navy, radio repair, or experimenting.

● TELLS HOW -

Employers make **JOB OFFERS** Like These  
to Our Graduates Every Month

Transcontinental Airline: "American Airlines is very much interested in receiving applications from CIRE trainees. We have immediate need for technicians in many cities."

West Coast Manufacturer: "We are currently in need of men with electronics training or experience in radar maintenance, and we would appreciate if you will refer interested persons to us."

Letter from nationally-known Manufacturer: "We have a very great need at the present time for radio electronics technicians and would appreciate any helpful suggestions that you may be able to offer."

These are just a few examples of the job offers that come to our office periodically. Some licensed technician filled each of these jobs . . . it might have been you!

**HERE'S PROOF FCC LICENSES ARE OFTEN  
SECURED IN A FEW HOURS OF STUDY  
With OUR Coaching AT HOME In Spare Time.**

Name and Address	License	Lessons
A/1C Ronald H. Person St. Louis 20, Mo. . . . .	1st	25 weeks
Milton L. Geisler, ET3 FPO, San Francisco, Calif. . . . .	1st	26 weeks
Marvin F. Kimball Lafayette, Ind. . . . .	2nd	21 weeks
L. M. Bonino Harlington AFB, Tex. . . . .	2nd	16 weeks
John E. Hutchison Bluefield, W. Va. . . . .	1st	27 weeks

Carl E. Smith, E. E., Consulting Engineer, President  
**CLEVELAND INSTITUTE OF RADIO ELECTRONICS**  
DESK RN-92, 4900 Euclid Bldg., Cleveland 3, Ohio  
Member, National Home Study Council

● TELLS HOW -

**EFFECTIVE JOB-FINDING SERVICE  
HELPS CIRE TRAINEES GET BETTER JOBS**

Here Are Just a Few Recent Examples of Job-Finding Results:

**ELECTRONICS TECHNICIAN**

"I am now employed by the Collins Radio Company as a Lab Technician. (This job was listed in your bulletin.) I have used the information gathered from your course in so many ways and I know that my training with CIRE helped me a great deal to obtain this job."

Charles D. Sindelar, Cedar Rapids, Iowa

**AIRLINES**

"I replied to the Job Opportunities you sent me and I am now a radio operator with American Airlines. You have my hearty recommendation for your training and your Job-Finding Service."

James A. Wright, Beltsville, Md.

**INDUSTRIAL ELECTRONICS**

"Upon my discharge from the Navy I used your Job-Finding Service and as a result I was employed by North American Aviation in electronic assembly (final checkout)."

Glen A. Furlong, Fresno, Calif.

Your FCC Ticket is recognized by employers as proof of your technical ability.

**GET ALL 3 FREE!  
MAIL COUPON NOW**

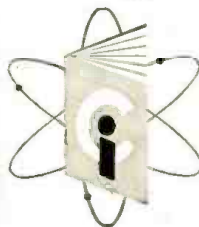

Cleveland Institute of Radio Electronics  
Desk RN-92-1900 Euclid Bldg., Cleveland 3, Ohio  
(Address to Desk No. to Avoid Delay)

Please send at once, without obligation, your FREE booklet, "How to Pass FCC License Examinations" (does not cover exams for Amateur License); a sample FCC-type lesson and the important new information booklet, "Money-making FCC License Information."  
PLEASE PRINT CLEARLY

NAME . . . . . AGE . . . . .

ADDRESS . . . . .

CITY . . . . . ZONE . . . . . STATE . . . . .

FOR PROMPT RESULTS, SEND AIR MAIL  
Special tuition rates to members of the U.S. Armed Forces  
Electronic Training also available to Canadian Residents



**NEW SERVICE-DESIGNED 1X2-A/B**



**NEW SERVICE-DESIGNED 6AL5**

# NOW G-E SERVICE- 54% OF YOUR

With 20 popular types you cut call-backs,

## Ready: 6 brand-new Service-Designed Tubes for increased volume!

**NEW 1X2-A/B.** *New filament shield post* ("lightning rod") helps to neutralize electrostatic pull of anode, reducing filament pull-outs to a minimum.

- Filament has special new coating that adheres closely, and will not flake off and expose the wire. Cuts tube arc-overs.
- Tubes are life-tested under actual operating conditions, including peak voltages that will be encountered. Assures dependable performance!

**NEW 6BK7-A, 6BQ7-A, 6BZ7.** *Improved heater design* provides better heater-cathode insulation. Cuts shorts to a minimum, acts to prevent tube burn-outs.

- Heater-cathode leakage is greatly reduced. Gives improved tube operation, and stabilizes tube performance.
- High zero-bias Gm. This increases tube gain and improves TV reception in fringe areas, giving a clearer, sharper picture.

PROTECTS  
AGAINST  
FILAMENT  
PULL-OUTS.



YOU CAN  
CROSS OFF  
HEATER-CATHODE  
SHORTS!



**NEW 6AL5.** *New, advanced heater design* limits initial voltage surges when tube is used in early-model series-string receivers. Same advantage applies in parallel-connected circuits. Tube flash burn-outs are greatly reduced. Vertical bars at right show approximate drop in initial voltage surges between heater of old tube and new Service-Designed 6AL5.

- New heater design also minimizes heater-cathode leakage. This is an important "plus" in AGC and video-detector applications.

**NEW 6CB6.** *New sprayed micas* combat interelement leakage, improving AGC performance by reducing any tube leakage in the controlled 6CB6 stages.

- Special-alloy screen grid gives superior heat dissipation. Result: freedom from G<sub>1</sub> and G<sub>2</sub> grid distortion and shorts.
- High zero-bias Gm, for improved fringe-area reception. Helps make the new 6CB6 a better-performing, more dependable tube!

HEATER VOLTAGE  
SURGES  
REDUCED.



REGULAR MICA  
DEPOSITS WILL  
CAUSE LEAKAGE.

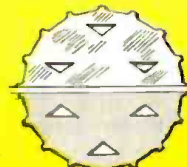

NEW, SPRAYED  
G-E MICA IS LEAK-  
AGE-RESISTANT!

**NEW SERVICE-DESIGNED**



**6BK7-A**

**6BQ7-A**

**6BZ7**



**NEW SERVICE-DESIGNED 6CB6**

# DESIGNED TUBES MEET REPLACEMENT NEEDS !

please customers on more than half your TV tube sales!

**E**VERY new General Electric Service-Designed Tube increases your profit opportunity. The 6 new types now available give you 20 Service-Designed Tubes in all . . . and by actual sales count for the year 1955, these 20 tubes meet 54 percent of your total TV replacement requirements!

Customer goodwill gets a big boost when you can put long life, improved performance into over half the tube sockets you fill! Call-back costs drop sharply. Your tube inventory needs are consolidated — for General Electric Service-Designed Tubes give top performance in *all* chassis!

G.E.'s first group of Service-Designed Tubes met 29 percent of all TV replacement needs. Now your sales potential is nearly doubled. Still more Service-Designed Tubes are in development . . . will increase your share of the tube market further.

Stock and install G-E Service-Designed Tubes! They cost no more than other tubes, are fully interchangeable with prototypes. They're widely advertised, nationally popular. Your G-E tube distributor has them. Phone him today! *Tube Department, General Electric Co., Schenectady 5, N. Y.*

**THESE 20 TUBES ARE "MONEY IN YOUR POCKET"!**

Clip out this list of General Electric Service-Designed Tubes . . . it will fit neatly in your wallet. A handy guide to types available!

1B3-GT	6AV5-GA	6BQ7-A	6CD6-GA
1X2-A/B	6AX4-GT	6BX7-GT	6J6
5U4-GA/GB	6BG6-GA	6BZ7	6SN7-GTB
5Y3-GT	6BK7-A	6CB6	12SN7-GTA
6AL5			25CD6-GB
	6BQ6-GA/6CU6		25BQ6-GA/25CU6

*Progress Is Our Most Important Product*

**GENERAL  ELECTRIC**

161-1A3

# Merit

FIRST IN EXACT REPLACEMENT.

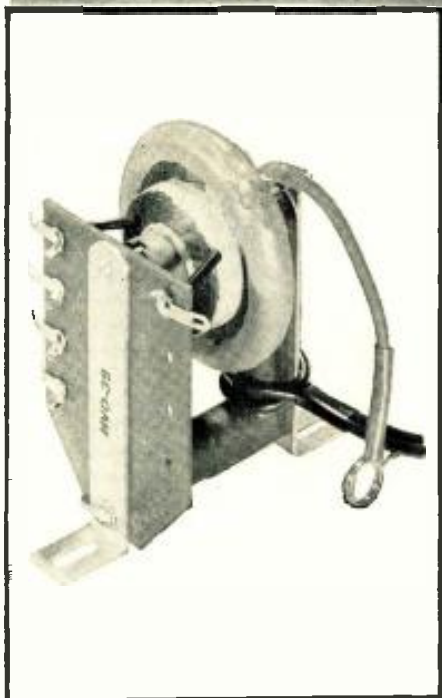

HVO-38 and HVO-54 FOR EXACT REPLACEMENT in ADMIRAL . . . another in the complete Merit line of exact and universal transformers, yokes and coils. Merit is the only manufacturer of transformers, yokes and coils who has complete production facilities for all parts sold under their brand name.

# Merit

MERIT COIL & TRANSFORMER CORP.  
4427 N. CLARK ST., CHICAGO 40, ILL.

## Spot Radio News

\* Presenting latest information on the Radio Industry.

By RADIO & TELEVISION NEWS'  
WASHINGTON EDITOR

A SENSATIONALLY DIFFERENT reallocation plan, that would shatter completely the present system, was under investigation by the Commission as this column was being prepared. The radical proposal calls for the exclusive assignment of the ultra-high channels from Chicago east, with Chicago down to New Orleans suggested as the dividing line, and everything west of this demarcation predominantly in the very-high camp.

The bold move was based on the conclusions that the dozen v.h.f. channels we now have are not adequate for a nationwide competitive system; the ultra-highs must eventually be used and must be given a lift so that they will surely succeed; and three or more competitive outlets must be provided in all or as many of the hundred basic markets as possible.

Aware of the complexity of the change, the plan noted that v.h.f. operators falling in the u.h.f. area would have a transition period of at least ten years (perhaps twelve) to amortize their very-high equipment costs. The proponents of the far-reaching idea also said that sometime during the

changeover period, perhaps about the middle, v.h.f. operators would be required to begin dual telecasting on the higher bands, as well as the v.h.f. channels. It was believed that during the transition period, the ultra-highs would certainly advance to a point where all of the shortcomings now present would disappear and u.h.f. transmission and reception would be comparable to current very-high service; perhaps improved, particularly insofar as noise problems are concerned. Present very-high area listeners would not suffer coverage loss, it was said, because extra ultra-high stations would begin operating and supply signal coverage originally available from fewer channel 2 to 13 stations.

Those favoring the plan say that the high-density population area in the eastern part of the country does not require broad very-high coverage; concentrated transmissions by many stations can do the job just as effectively, and u.h.f. can provide such service.

THE FIERY NETWORK-DOMINATION probe, underway in Washington for many months, was hit by a blockbust-

## NEW TV GRANTS SINCE FREEZE LIFT

Continuing the listing of construction permits granted by FCC since lifting of freeze. Additional stations will be carried next month.

STATE	CITY	CALL	CHANNEL	FREQUENCY	POWER*
Idaho	Pocatello	_____	6	82-88	69
Maine	Presque Isle	_____	8	180-186	11.8
Nebraska	Omaha	_____	7	174-180	39.45
New York	Elmira (Satellite)	_____	18	494-500	15.4
Virginia	Bristol	_____	5	76-82	100

### NEW CALL LETTER ASSIGNMENTS

California	Redding	KVIP	7	174-180
California	Sacramento	KGMS-TV	46	662-668
Pennsylvania	Philadelphia	WSES	29	560-586
Kansas	Ensign	KTVC	6	82-88

### CALL LETTER CHANGES

Colorado	Grand Junction	KREX-TV (formerly KFXJ-TV)	5	76-82
Colorado	Montrose	KFXJ-TV (formerly KREX-TV)	10	192-198
Ohio	Cleveland	WJW-TV (formerly WXEL)	8	180-186
New York	Albany	WCDA (formerly WROW-TV)	41	632-638
New York	Hagaman	WCDB (formerly WAST)	29	560-586

\*ERP=(effective radiated power, kw.)

**RCA** offers you the finest training at home in Radio-TV electronics, TV servicing, Color TV

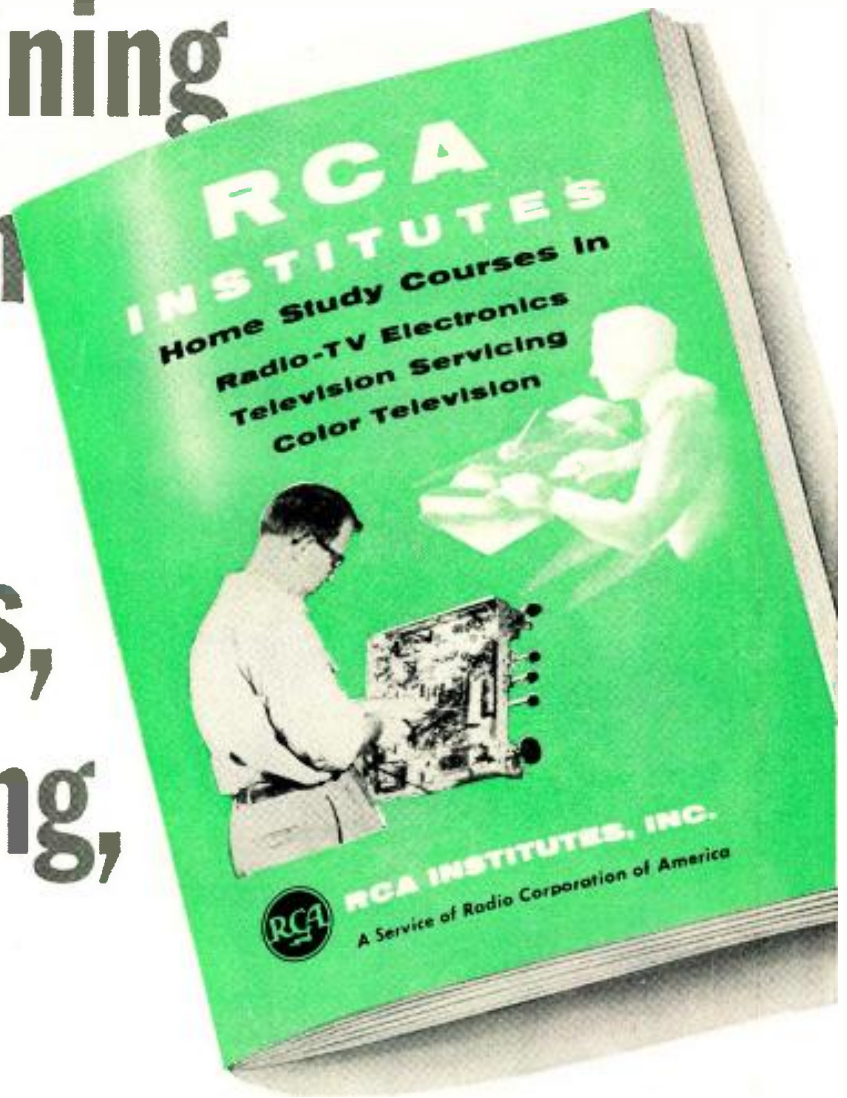

**SEND FOR THIS FREE BOOK NOW!**

The instruction you receive and equipment you get (and keep) will start you on your way. Pay-as-you-learn. You pay for only one study group at a time. This 52 page book contains complete information on Home Study Courses for the beginner and the advanced student.



**RCA INSTITUTES, INC.**  
*A SERVICE OF RADIO CORPORATION OF AMERICA*  
 350 WEST FOURTH STREET, NEW YORK 14, N.Y.

RCA Institutes, Inc., Home Study N-76.  
 350 West Fourth Street New York 14, N. Y.  
 Without obligation, send me FREE CATALOG on Home Study Courses in Radio, Television and Color TV. No salesman will call.

Name .....  
 Please Print  
 Address .....  
 City ..... Zone ..... State .....

**IMPORTANT**  
 Be sure to write for RCA Institutes catalog before signing up for any Radio-TV course

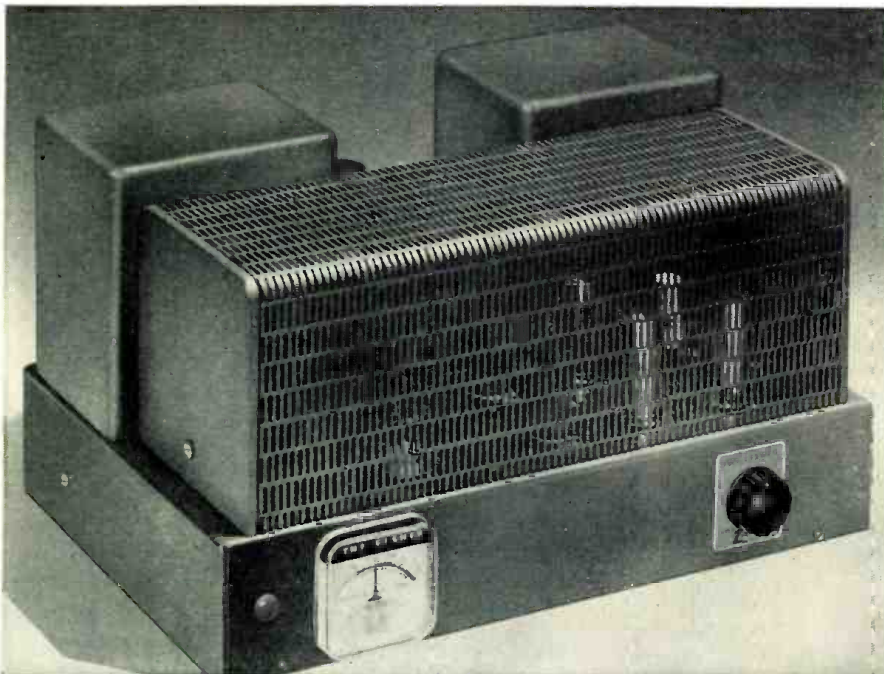

WORLD'S FINEST ALL-TRIODE AMPLIFIER • EQUIPPED WITH POWER MONITOR AND Z-MATIC

**New!**

THE   
**FISHER**

**55 Watt Amplifier**

**P**LENTY OF POWER for your present — and any possible *future* needs. The new Model 55-A is a laboratory instrument designed for home use. Delivers 55 watts at less than 1% distortion — and handles 110-watt power peaks! Drives even the lowest efficiency loudspeaker system to full output. Exclusive FISHER POWER MONITOR, a full-size, illuminated Power Output Meter, makes possible correct adjustment of output tube bias. It also indicates average audio power. Completely new Z-MATIC Variable Damping Factor Control. Has *three times* the range of ordinary controls. Massive transformers, laced cable wiring, terminal board construction — all are in the FISHER tradition. **\$169.50**

**Outstanding Features of THE FISHER 55-A**

- Less than 1% harmonic distortion at 55 watts (0.05% at 5 watts, 0.08% at 10 watts.)
- Handles 110 watts peak.
- IM distortion below 0.4% at 10 watts (0.8% at 45 watts, 2% at 50 watts.)
- Uniform response  $\pm 0.1$  db 20 to 20,000 cps. (within 1 db, 5 to 100,000 cps.)
- Power output constant within 1 db at 50 watts, 15 to 60,000 cps.
- Hum and noise better than 92 db below full output!
- Bias Control to balance output tubes.
- Z-MATIC provides variable damping, from 32 to 0.03.
- Less than 1 volt input produces full output.
- Input Level Control.
- 8 and 16-ohm output impedances.
- Auxiliary AC receptacle. SIZE: 14 $\frac{1}{4}$ "w. x 9 $\frac{3}{8}$ "d. x 8 $\frac{3}{8}$ " high. SHIPPING WEIGHT: 50 lbs.

*Price Slightly Higher In The West*

WRITE TODAY FOR COMPLETE SPECIFICATIONS

**FISHER RADIO CORP. • 21-23 44th DRIVE • L. I. CITY 1, N. Y.**

er report a few weeks ago, which came from the office of the former chairman of the Senate Interstate and Foreign Commerce Committee, Senator John W. Bricker, and bluntly tagged the networks as the . . . "yoke of economic dominance."

The Senator's essay, titled "The Network Monopoly," asked that the FCC be authorized to regulate the networks, and that service areas of existing v.h.f. stations in high-density zones be reduced, to protect market value, by lowering power and antenna heights.

Commenting on the profits made by the networks, the Senator said that the two major systems . . . "exercise a stranglehold over the entire industry."

**A NEW TYPE OF RADIO TELESCOPE**, a microwave spectroheliograph, will soon begin the task of exploring the sun's turbulent atmosphere, under the direction of the Air Research and Development Command's Air Force Office of Scientific Research.

Based on an idea conceived by members of Stanford University, the device will be used to pick up solar microwave radiations in the 3000-megacycle region. It will be located on the University's campus and employ 32 parabolic aluminum antennas, aligned in two rows to form a huge cross occupying a level, two-acre meadow.

As the dish antennas scan the sun's surface in the same way a TV camera scans its subject, the photographs produced show the *chromosphere*, a hitherto mysterious billowing layer of incandescence, rising to heights of 6000 miles above the sun's surface.

Although discovered many years ago at the time of solar eclipses, little is known about the chromosphere. The development of radio astronomy in the postwar era has renewed efforts to unveil its secrets. It is believed to have some connection with sunspots which, in turn, are related to magnetic storms which interrupt radio communications.

The elaborate network of 32 antennas will look straight at the sun, scanning its surface in unison and following automatically as it crosses the sky. A photograph of the entire solar orb will be completed in about two hours. Clouds, tests have shown, will not affect antenna efficiency.

An important accomplishment of the dish scanners will be the scanning of solar regions as small as three-thousandths of one square degree; a definition finer than ever before achieved in radio astronomy or in radar.

**THE AIR RESEARCH AND DEVELOPMENT COMMAND** has also announced the construction of the first trainer capable of teaching Air Force radar operators to guide their aircraft to a target, bomb the target and return, completely and solely with shoran (short-range navigation) radar.

Built at a cost of \$100,000, the trainer offers radar operators complete instruction in the use of shoran radar



# PROFIT COMES BACK!

to phono cartridge and needle market with

*Electro-Voice*®

**POWER-  
POINT**

(THE CARTRIDGE WITH  
JEWELED\* PLAYING TIPS)

## CUT INVENTORY COSTS

Power-Point Replaces over 90%  
of All Popular Phono Cartridges

## REPLACE CARTRIDGE AND NEEDLE IN SECONDS

(Just Slip Out—Slip In)

E-V Power-Point actually gives you more working capital by cutting, drastically, the number of different cartridges and different needles you need in stock to do an adequate replacement business. Power-Point *alone* replaces over 90% of all popular phono cartridges. You save valuable time, troublesome service calls . . . you can replace Power-Point in less time than it takes to read this sentence! Remember too, almost a million Power-Points are now in use, and the number is growing fast. Additional millions will be demanded by the replacement market!

### What is Power-Point?

A nylon-encased unit combining ceramic cartridge and two jeweled\* playing tips. A Power-Point cartridge can be changed in seconds, replaces virtually all popular phono cartridges, costs less than two needles alone. It has low inertia, superior tracking ability, wide range, low distortion, minimum needle noise and record wear. It is non-inductive, hum-free, unaffected by moisture or temperature. It actuates all changer mechanisms.

\*Superior synthetic sapphire or natural diamond.

### Four Power-Point Types, each \$3.95 list

Model 51-1 (Red): two 1-mil sapphire tips.

Model 52-2 (Green): two 2-mil sapphire tips.

Model 53-3 (Black): two 3-mil sapphire tips.

Model 56 (Blue): turnover mounted 1-mil and 3-mil sapphire tips

### Three Mounting Mechanisms

Model PFT-1 Power-Point Fixed Mount, 50c list.

Model PT-1 Power-Point Turnover Mount, \$1.00 list.

Model PT-2 Power-Point Turnunder Mount, \$1.00 list.

MAIL COUPON TODAY!

*Electro-Voice*

ELECTRO-VOICE, INC., BUCHANAN, MICHIGAN

Send me complete information about Electro-Voice Power-Point cartridges, sales-aids and display.

Company \_\_\_\_\_  
Address \_\_\_\_\_  
City \_\_\_\_\_ State \_\_\_\_\_  
Signed \_\_\_\_\_



THE WORLD'S PREMIER MASTER CONTROL AMPLIFIER • EQUIPPED WITH TONESCOPE

# Versatile! Powerful!

THE   
**FISHER**  
 Master Control Amplifier

MODEL CA-40

COMPLETE IN EVERY respect — and it's by FISHER! Our new Model CA-40 Master Control Amplifier offers, on one compact chassis, the most advanced preamplifier with controls, as well as a powerful 25-watt amplifier with less than 1% distortion at full output. Among the many outstanding features of the CA-40 is another FISHER First — ToneScope, a graphic presentation of Tone Control settings. All this in a handsome, two-tone cabinet suitably designed both for table-top and shelf installation. THE FISHER CA-40 is the culmination of three years of intensive research and development and reflects in every respect the creative engineering that has made THE FISHER world-renowned.

**\$139.50**

### Leading Features of THE FISHER CA-40

- Six inputs, including Tuner, Magnetic Phono, Mic and two Auxiliary. Input Level Adjustments. ■ Uniform response 10 to 90,000 cycles  $\pm$  0.5 db. Constant power within 1 db at 25 watts. 17 to 30,000 cycles. ■ 0.3 volts on high level. 0.005 volts on low level inputs produces full 25-watt output. ■ Less than 1% distortion at rated power. ■ Three-position Rumble and Noise Filters, with panel indicator lights. ■ Six equalization positions. ■ Direct tape-head playback. ■ Balanced Spectrum Bass and Treble Controls, providing 15 db boost or cut. ■ ToneScope: graph-form indication of Tone Control Settings. ■ 4, 8 and 16-ohm speaker outputs. ■ Cathode follower recorder output. ■ DC filament voltages on all low-level stages. ■ Shielded, shock-mounted construction. ■ CONTROLS: Bass, Treble, Main On-Off, Function Selector, Volume, 4-Position Loudness Contour, Rumble Filter, Noise Filter. SIZE: 12 $\frac{3}{4}$ " wide x 10 $\frac{3}{8}$ " deep x 5" high. ■ SHIPPING WEIGHT: 24 pounds.

*Price Slightly Higher In The West*

WRITE TODAY FOR COMPLETE SPECIFICATIONS

**FISHER RADIO CORP. • 21-23 44th DRIVE • L. I. CITY 1, N. Y.**

under all simulated flight conditions. Adaptable to six types of shoran for bombing, photo reconnaissance and aerial mapping, the equipment uses short-range radar to navigate on bombing runs or to keep reconnaissance aircraft on the correct course while photographing.

The trainer, a complex affair, will enable the Air Force to do synthetically what it never could do in flight: chart the entire course and altitude of the shoran bombing run, and then study the data to pinpoint any errors that are made. Before this trainer was built, shoran training was done in actual flight where the only record of success or failure was how close the bomb came to the target. There was not, as there is now, any record to show where errors along the bombing course had caused a miss.

The heart of the shoran trainer is an electromechanical analogue computer, which makes it possible to set problem bombing runs, controlled by simulated shoran radar waves.

In operation, a problem is set up on the computer, establishing the target. The instructor acts as pilot of the imaginary aircraft and flies the simulated mission from a console. The student sits before a radar scope at a separate console. The student shoran operator, controlling his equipment and observing his radar scope, tells his instructor what course to follow to the target. The instructor introduces adverse effects into the flight, simulating enemy radar-jamming in any of six ways. The student must attempt to stop the jamming and properly direct his instructor so as to keep the aircraft on a precise course.

In the meantime, a large plotting board is charting the first portion of the bombing run. When the flight reaches the last five miles, the plotter switches to an expanded scale to give a highly detailed record of the final distance to the target, the automatic bomb release point and the strike of the bomb. The charted course is then studied and the student learns what mistakes he made, if any, and how to avoid them in the future.

FOR THE FIRST TIME, under lab conditions, man has produced temperatures of well over 400,000 degrees Fahrenheit and corresponding brightness 700 times greater than at the surface of the sun.

The incredible temperature and subsequent brightness are the result of investigations into the physics of high energy, high temperature and gaseous discharge by scientists of the ARDC.

Temperatures which have been measured by the lab are of exceedingly short duration, less than a millionth of a second, but an important outgrowth of this research was the design of equipment capable of accurately measuring the powerful and extremely fast pulsed electrical spark discharge.

The extremely high temperatures involve the release of electric energy

**AVAILABLE NOW**

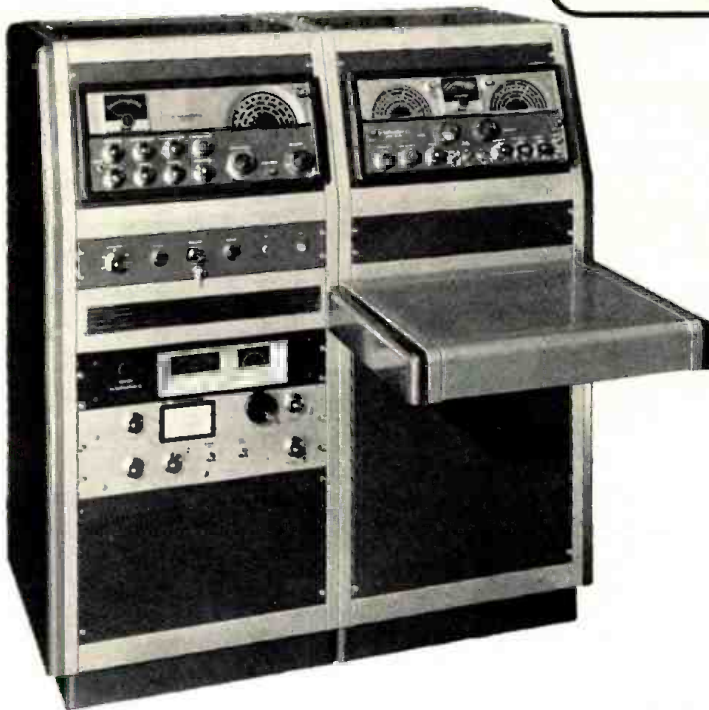

For more than 22 years Hallicrafters has been closer to the radio amateur field than any other communications manufacturer. The many leading Hallicrafters developments have been based on what the amateur wanted and needed. The result of this close association is this radio man's ideal—the finest component units (Model SX-100 AM-CW-SSB receiver, Model HT-30 transmitter-exciter, Model HT-31 linear power amplifier) in a completely packaged radio station—

**MODEL SR-500.**

**\$1495<sup>00</sup>**

**FOR THE FIRST TIME**  
*commercial broadcast styling in a*  
**complete amateur radio station.**  
**HALLICRAFTERS MODEL SR-500**  
*a single package for*  
**PROFESSIONAL EFFICIENCY**

#### FEATURES

Here is a completely contained unit in a handsome console cabinet—transmitter/exciter, linear power amplifier, receiver affording the finest in V.F.O. or crystal. SSB, AM and CW transmission and reception. You need supply only the antennae, microphone and AC power. All the wiring is complete and external connections are provided for antennae and microphone.

The transmitting and receiving units are located in coordinated operation for maximum efficiency, and a special communications speaker is positioned above the operating shelf directly in front of the operator.

The mobile console is mounted on casters and is easily expandable. Three blank panels are also provided in the basic cabinet for the installation of any additional equipment that may be desired.

The console incorporates all safety and protective features. It is completely enclosed, fused with the main power relay controlled by a key lock. For "extra" safety, the entire back of the cabinet is enclosed but perforated for maximum ventilation and heat dissipation.

#### FRONT PANEL CONTROLS, INDICATORS AND CONNECTIONS:

1. Antenna selector switch for 80, 40, 20, 11-10 meter and dummy or special antenna.
2. Master power switch "key lock" type operates main power relay to turn on or off all equipment.
3. Main power pilot lamp.
4. "On the air" pilot lamp.
5. Microphone input.
6. Key jack.

#### REAR PANEL:

1. Five coaxial connectors for 80, 40, 20, 11-10 antenna and dummy load or special antenna.
2. Dual 30 ampere fuse block.
3. Three spare AC power outlets.
4. Spare octal socket for beam controls, etc.

For further information see your Radio Parts Distributor or write

**hallicrafters**

CHICAGO 24.

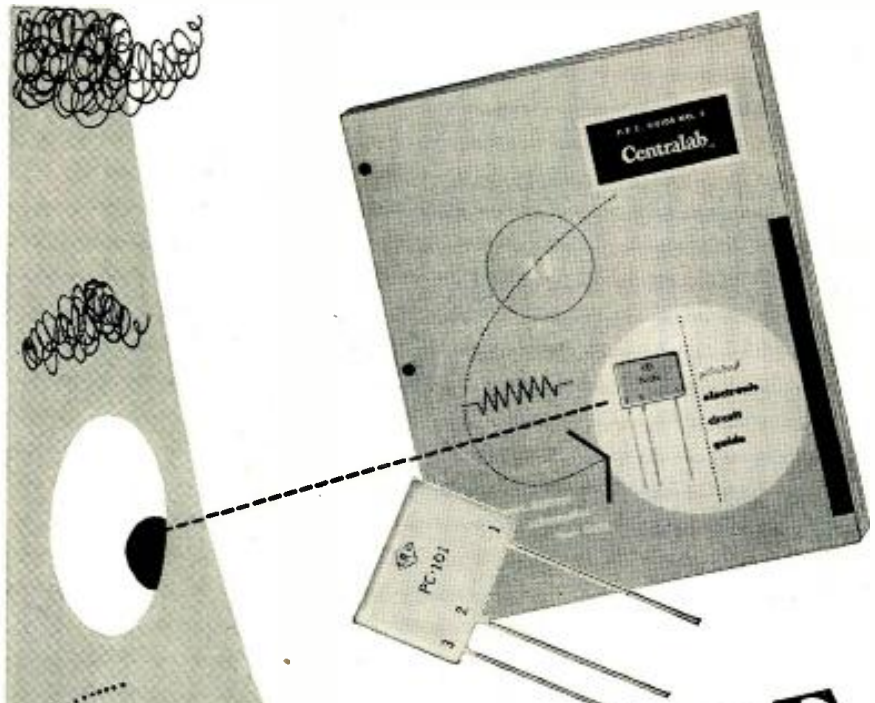

# LOOK HERE

for the right Packaged Electronic Circuit

## Centralab's Free P.E.C.\* Guide No. 3

- ◆ Lists 130 radio and TV manufacturers and their P.E.C. applications — showing part identification, manufacturer's part number, and Centralab catalog number.
- ◆ Tells how you can easily test Centralab P.E.C.'s with a VOM and a simple 60-cycle capacitor bridge.
- ◆ Shows schematics that guide you in using P.E.C.'s to replace entire sections of old-style circuits, thus saving time otherwise wasted trying to locate a shorted or intermittent component.
- ◆ More than 60,000,000 Centralab Packaged Electronic Circuits are now in use.

Ask your Centralab distributor for P.E.C.'s. He has 45 different types in stock. Send coupon for free copy of P.E.C. Guide No. 3.

# Centralab

A DIVISION OF GLOBE-UNION INC.  
 910G East Keefe Avenue, Milwaukee 1, Wisconsin Y-5619

Send me free copy of Centralab P.E.C. Guide No. 3.



Name.....  
 Company.....  
 Address.....  
 City..... Zone..... State.....

\*Trademark

into a very small volume of inert gas under high pressure.

A specially designed capacitor circuit is employed to store the energy and release the electric discharge. This capacitor circuit, applied to the basic gaseous discharge technique, is primarily responsible for the resultant high temperatures.

In the past, those working in the field were unable to determine with accuracy the temperatures which they were able to generate. Now, because of the ARDC development, accurate measurement of the temperature and the brightness can be calculated.

**DATA-PROCESSING** shared by two interconnected electronic high-speed digital computers, the *Seac* and *Dy-seac*, has been successfully performed in Washington at the labs of the Bureau of Standards.

The two computers designed and built at the Bureau worked cooperatively on a common task to demonstrate program-controlled machine intercommunication in which coordinated programs were read into both machines. The problem simulated a situation where stock-transaction reports are tabulated and summarized for fiscal accounting, and then forwarded for posting to inventory control records elsewhere. The experiments were carried out as part of a program with the Navy Bureau of Supplies and Accounts to investigate the application of electronic techniques to the problems of supply management.

Typical applications of digital computers as data processors involve replacement of many small specialized machines by a single automatic system. However, for massive paper-handling operations, or for large-scale activities requiring the processing of the same data for different purposes at different locations, the use of more than one high-speed data processor may be necessary. For instance, in the far-flung supply organizations of the armed forces, expediting flow of information is essential to efficient supply management. Automatic communication between machines has been foreshadowed by direct input and output provisions, so that the computer continues with other useful work, while transfers of information between it and external devices are in process, and by tape-processing devices where search is under the program control of a computer. In this example, however, the interconnection is between a computer serving as the nucleus of a processing system and other parts of the same computer system.

Most general-purpose electronic computers employ a generally compatible digital language, can receive and transmit data in the form of electrical signals by way of standard communication channels over any desired distance, and can alter the course of processing programs in accordance with new or revised information. It should therefore be possible to inter-

**RADIO & TELEVISION NEWS**

Just Printed! Send for this

# FREE

booklet today!

see  
what the  
rapidly  
expanding  
field of

# ELECTRONICS

offers  
you

- BETTER JOB
- BETTER PAY
- PROMOTION
- GREATER SECURITY
- GREATER CONFIDENCE
- BETTER LIVING FOR YOU AND YOUR FAMILY

All these benefits can be yours if you act now! Take that first big step this minute —No obligation whatsoever!

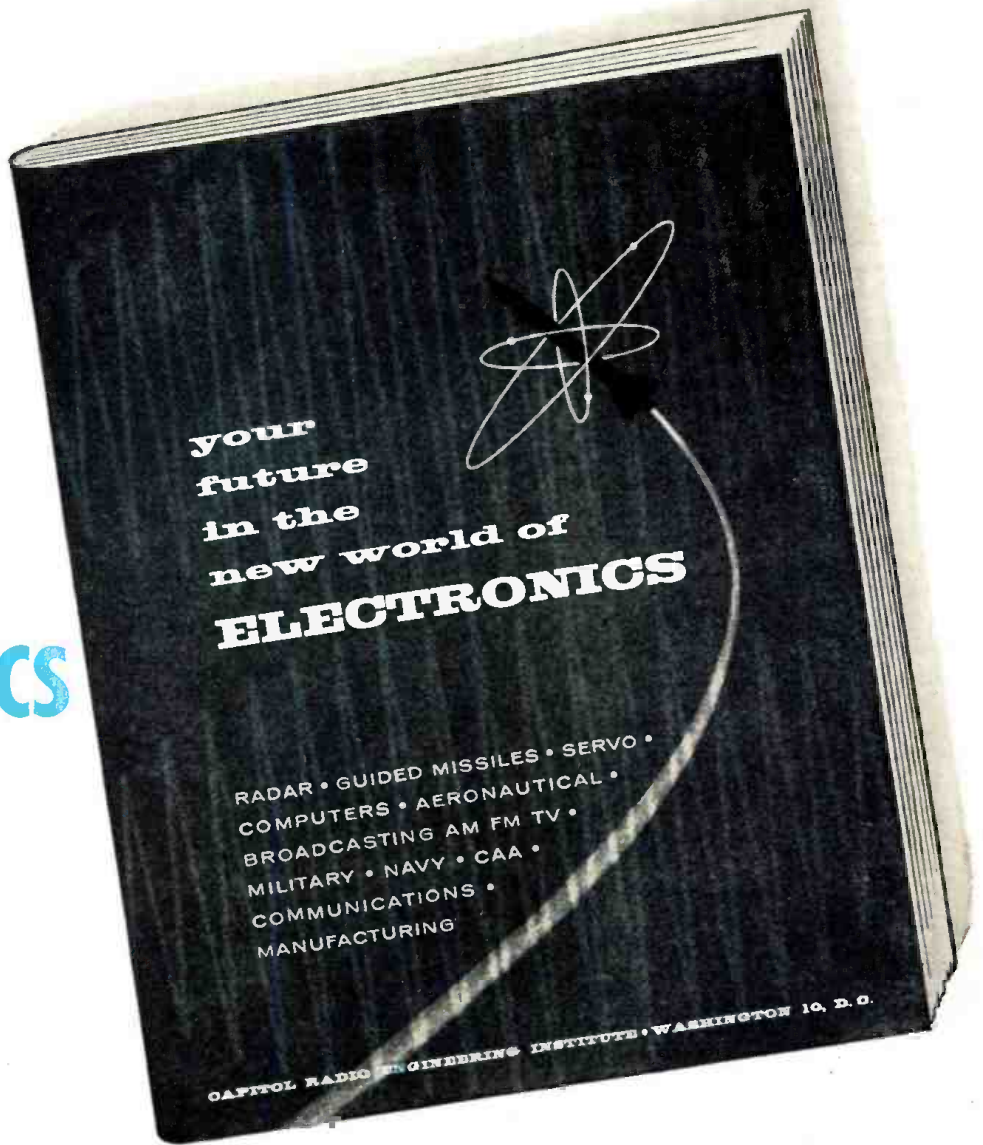

### TAKE A MINUTE TO MAIL THIS COUPON FOR FREE BOOKLET !

**CAPITOL RADIO ENGINEERING INSTITUTE**  
 Accredited Technical Institute Curricula      Founded 1927  
 Dept. 117-C, 3224-16th St., N. W., Washington 10, D. C.

*Please send me your course outline and FREE illustrated Booklet "Your Future in the New World of Electronics" . . . describing opportunities and CREI home study courses in Practical Electronics Engineering.*

CHECK FIELD OF GREATEST INTEREST }  Practical Radio Electronics Engineering  
 Broadcast Radio Engineering (AM, FM, TV)  
 Practical Television Engineering  
 Aeronautical Electronics Engineering      **H**

Name \_\_\_\_\_  
 Street \_\_\_\_\_  
 City \_\_\_\_\_ Zone \_\_\_\_\_ State \_\_\_\_\_

CHECK:  Home Study     Residence School     Korean Veteran

To help us answer your request intelligently, please give the following information:

EMPLOYED BY \_\_\_\_\_  
 TYPE OF PRESENT WORK \_\_\_\_\_  
 SCHOOL BACKGROUND \_\_\_\_\_  
 ELECTRONICS EXPERIENCE \_\_\_\_\_  
 IN WHAT BRANCH OF ELECTRONICS ARE YOU MOST INTERESTED?  
 \_\_\_\_\_  
 \_\_\_\_\_



# RCA

ANNOUNCES OPPORTUNITIES

## In Guided Missile Test Instrumentation For Electronic Technicians

*At the following locations*

### PATRICK AIR FORCE BASE, FLORIDA

Engineering development technicians  
Radar  
Communications  
Test Equipment

### CAPE CANAVERAL

Radar	Timing
Radio	Telephone
Telemetry	Optics

*Enjoy pleasant Florida living and working at these locations.  
Liberal company benefits. Relocation assistance.*

### INTERESTING DOWN-RANGE ASSIGNMENTS

Radar	Telemetry	Telephone
Radio	Timing	Optics

*These positions are located on the Islands shown on the map above. Salary, 30% incentive, meals and lodging furnished. Return to U.S. every 3 months.*



*For information and arrangements for personal interview, send complete resume to:*

Mr. H. C. Laur  
Technical Employment, Dept. N-16G  
Missile Test Project  
RCA Service Co., Inc.  
P.O. Box 1226, Melbourne, Florida



## RADIO CORPORATION of AMERICA

connect two or more general-purpose machines so that they can cooperate on a common task. For example, a versatile large-capacity data processor at a material control center might receive data fed to it automatically by smaller computers located at various supply depots. The supervisory processor (at the center) might so control the system-wide processing that it would accept data from each of its reporting sources in a scheduled sequence, but would also be free to accept and handle priority requests for supply action from any of the Armed Forces supply depots at any time.

For the kind of interaction where both information and exchanges of control are transferred between computers, the question of programmed control *versus* automatic interruption is particularly important. Programmed control depends, to a considerable extent, on human anticipation of when and how the interchanges should occur; however, if two or more systems are to interact automatically without human intervention, provision must be made for automatic interruption of a program in process in order to turn to the new information just received from another system. Such interruption properties are available from the *Dyseac* computer.

A cable between the *Seac* building and a trailer housing *Dyseac* provides interconnection through a regular input-output terminal on each machine. Information transfers were initiated and terminated by the transmission of control signals between the two machines. Whenever a *Seac* output instruction called for selection of the particular output used for transmission to *Dyseac*, a 62-volt preparatory signal was sent from the *Seac* external selector unit to *Dyseac*. This signal activated appropriate monitor operations in *Dyseac*. As soon as *Dyseac* was ready to accept the data, it transmitted a 62-volt signal to *Seac*. Only upon receipt of this signal was *Seac* able to proceed with its next instruction. In effect, *Seac* continued trying to complete this output instruction, until *Dyseac* signalled readiness to accept the transfer of the information *Seac* was holding for processing.

ONCE AGAIN, grants continued to move along; however, v.h.f. channels predominated in the approvals issued as we went to press, as the listing on page 14 reveals.

THE SPECTACULAR PERFORMANCES TV can provide will be on view this summer at the St. Lawrence power project near Massena, N. Y., when through the use of cameras and microwave television, tourists will be able to view construction work on the dams. TV cameras will be mounted on towers and rotated to cover an arc of operations. About 200 will be able to watch video pickups on three receivers at one time. A mighty tribute to TV's maturity. . . . L. W.

RADIO & TELEVISION NEWS



L. C. Lane, B.S., M.A. President, Radio-Television Training Association. Executive Director, Pierce School of Radio & Television.

# VETERANS - - NON-VETERANS LET ME HELP YOU EARN TOP MONEY in TELEVISION — as I've helped these men —

## LEARN TELEVISION AT HOME IN YOUR SPARE TIME

Now, while demand for trained men is rising, you can prepare for a top-pay, life-time career as an electronic technician, television repairman, or studio technician . . . or set up your own profitable business. You don't need any experience whatsoever to add your name to my list of hundreds of successful graduates.



### LEARN BY DOING

As part of your training I give you the equipment you need to set up your own home laboratory and prepare for a BETTER-PAY TV JOB. You build and keep an Electromagnetic TV RECEIVER designed and engineered to take any size picture tube up to 21-inch. (10-inch tube furnished. Slight extra cost for larger sizes.) . . . also a Super-Het Radio Receiver, AF-RF Signal Generator, Combination Voltmeter-Ammeter-Ohmmeter, C-W Telephone Transmitter, Public Address System, AC-DC Power Supply. Everything supplied, including all tubes.

### STUDY NEWEST DEVELOPMENTS

My training covers all the latest developments in the fast-growing Television-Radio-Electronics industry. You learn about FM — RADAR — COLOR TV — TRANSISTORS — PRINTED CIRCUITS, etc.

### CHOOSE FROM THREE COMPLETE COURSES

covering all phases of Radio, FM and TV

1. Radio, FM and Television Technician Course — no previous experience needed.
2. FM-TV Technician Course — previous training or experience in radio required.
3. TV Cameraman and Studio Technician Course — advanced training for men with Radio or TV training or experience.

### EXTRA TRAINING IN NEW YORK CITY AT NO EXTRA COST!

After you finish your home study training in Course 1 or 2 you can have two weeks, 50 hours, of intensive Lab work on modern electronic equipment at our associate resident school, Pierce School of Radio and Television. THIS EXTRA TRAINING IS YOURS AT NO EXTRA COST WHATSOEVER!

### FCC COACHING COURSE

Important for BETTER-PAY JOBS requiring FCC License! You get this training AT NO EXTRA COST! Top TV jobs go to FCC-licensed technicians.

### EARN WHILE YOU LEARN

Almost from the very start of your course you can earn extra money by repairing sets for friends and neighbors. Many of my students earn up to \$25 a week . . . pay for their entire training with spare time earnings . . . start their own profitable service business.

**FREE!** I'll send you my new 40-page book, "How to Make Money in Television - Radio - Electronics," a Free sample lesson, and other literature showing how and where you can get a top-pay job in Television.

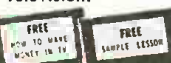

# Radio Television Training Association

52 EAST 19th STREET • NEW YORK 3, N. Y.

Licensed by the State of New York • Approved for Veteran Training

July, 1956

### AIRCRAFT INSPECTOR

"With RTTA training and through repairing radios and televisions for the right people at the right price, I was able to make the right contacts. I am now an Inspector for Douglas Aircraft at about \$125 a week."



Hugh Maddox, Los Angeles, Calif. 6/30/54

### \$60 A WEEK IN SPARE TIME

"I have the skill and know-how to do the work I love best and to enjoy better things in life, thanks to RTTA. I am now working at TV Servicing and making \$60 a week spare time."

Harold Gimlen, Flint, Mich. 6/21/54

### ASSISTANT MANAGER

"I am Assistant Manager of Day and Nite TV Service."

Ronald W. Curry, Tulsa, Okla. 1/2/55



### EARN'S EXTRA MONEY

"RTTA training gave me a chance for my own business, extra money earned, and more things that the price of the course could never equal."

Bryce Ruttle, Peterborough, Ontario, Can. 4/21/55

### FEELS FULLY QUALIFIED

"With your training I feel fully qualified to get out and compete with all radio mechanics in this area. I have over \$1,500 invested in test equipment, \$1,000 in tube stock and \$200 in miscellaneous equipment. Since I haven't had one complaint in 9 months I have been servicing sets, your school must have done a good job."



Jim Martin, Collinsville, Ill. 3/27/55

## VETERANS

My School fully approved to train Veterans under new Korean G. I. Bill. Don't lose your school benefits by waiting too long. Write discharge date on coupon.

### MAIL THIS COUPON TODAY!

Mr. Leonard C. Lane, President  
RADIO-TELEVISION TRAINING ASSOCIATION  
Dept. T-7C, 52 East 19th Street, New York 3, N. Y.

Dear Mr. Lane: Send me your NEW FREE BOOK, FREE SAMPLE LESSON, and FREE aids that will show me how I can make BIG MONEY in TELEVISION. I understand I am under no obligation.

(PLEASE PRINT PLAINLY)

Name \_\_\_\_\_ Age \_\_\_\_\_

Address \_\_\_\_\_

City \_\_\_\_\_ Zone \_\_\_\_\_ State \_\_\_\_\_

I AM INTERESTED IN:

- Radio-FM-TV Technician Course
- FM-TV Technician Course
- TV Cameraman & Studio Technician Course

**VETERANS!**

Write discharge date

**NO OBLIGATION!**

MISS COLOR-TV OF 1956 AND YOUR RCA TUBE DISTRIBUTOR



present:  
*The Famous RCA Institutes'*

# COLOR-TV HOME STUDY COURSE\*

free of extra charge when  
you buy RCA Receiving Tubes



*Expanded RCA course—includes  
two new lessons, never before  
offered, giving you all the  
latest information on "Big Color" TV*

This offer is for a limited  
time only. Enroll now and  
receive this durable  
binder for your lessons.

Now is the time to enroll in RCA's extended Color-TV Home Study Course. Be set to cash in on the tremendous opportunity Color-TV holds for you. It is a practical and down-to-earth course—prepared by Color-TV experts just for service technicians.

Go to your regular RCA Tube Distributor and ask for full details.

P.S.: If you're one of the thousands who has completed RCA's previous 9-lesson course, bring yourself up-to-date with the new advanced lessons. Special "Certificate" awarded.

## 11 Steps to Profit in Color-TV Servicing

### THE BASIC 9 LESSONS

- 1 Introduction to Color-TV
- 2 Principles of Two-Phase Modulation and Colorimetry
- 3 Principles of Color-TV Receivers
- 4 Color Kinescopes
- 5 The Color-TV System
- 6 Color-TV Receiver Circuits
- 7 Set-up and Adjustment of Color-TV Receivers
- 8 Servicing and Alignment of Color-TV Receivers
- 9 Test Equipment for Color-TV Servicing

### PLUS 2 Brand New Advanced Lessons

- 10 Large Screen Color
- 11 New Color-TV Circuitry



**RCA RECEIVING TUBES**

RADIO CORPORATION OF AMERICA

HARRISON, N. J.



# NATIONAL SCHOOLS

*proudly presents*

FOR MEN  
WHO WANT  
TO EARN  
MORE MONEY

## TELERAMA • ALL 8 BRANCHES OF TELEVISION • ELECTRONICS • RADIO IN ONE DYNAMIC, MODERN SHOP METHOD, HOME TRAINING COURSE

\*Registration applied for

Another great advance in **HOME STUDY TRAINING**. Let National Schools, of Los Angeles, a practical Technical Resident Trade School for over 50 years, train you at home by Shop-Method, for today's unlimited opportunities in **ALL 8 BRANCHES** of the Television, Electronics, Radio Industry.

Check all you receive in *One Master Course* at *One Low Tuition*

1. Television — Including Color TV
2. Radio — FM and AM
3. Industrial Electronics
4. Sound Recording and Hi-Fidelity
5. Preparation for FCC License
6. Automation
7. Radar and Sonar
8. Communications

ALL OF THIS MODERN, NEWEST, PRACTICAL EQUIPMENT IS YOURS TO KEEP!

- Parts to Build a modern TV set, including large screen Picture Tube.
- Parts to build a powerful Superher Receiver, standard broadcast and short wave.
- Parts to conduct many experiments and build Continuity Checker, RF Oscillator, TV Circuits, Audio Oscillator, TRF Receiver, Signal Generator.
- Professional Multitester
- These are a MUST for all technicians.

### YOU DO MANY PRACTICAL JOBS.

You do servicing, circuit analysis and many other down-to-earth experiments. You build a modern TV set from the ground up... with equipment kits we give you, including a new large screen picture tube and professional Multitester, at no additional charge.

**EARN AS YOU LEARN!** Many of our students earn their entire tuition and more in Spare Time jobs we show them how to do while learning. **YOU GET GRADUATE ADVISORY SERVICE, TOO.**

ALL YOURS  
TO KEEP

**L. J. ROSENKRANZ**  
President of NATIONAL SCHOOLS



This Master-Shop-Method course is completely up-to-date. Here in Los Angeles, the TV and Electronics center of the world, we are able to keep in constant touch with the industries' latest developments. As a student, you will quickly master all phases at home... in your spare time Your earning power will grow with every lesson. Just as thousands of National Schools graduates do every day, you can handle servicing, manufacturing, repairing, hundreds of other jobs, or make good money in your own business. **SECURE YOUR FUTURE—NOW SEND COUPON BELOW.**



IN THESE MODERN TV STUDIOS, SHOPS AND LABORATORIES, your Shop Method Home Study Course was developed by experienced instructors and engineers. What an advantage that is to you at home — each lesson is tested, proved, easy to understand. You can master the most up-to-date projects, such as color TV set repair, printed circuits — even prepare for F.C.C. License and industrial electronics without taking a special course. **TAKE YOUR FIRST STEP NOW TO A TOP-PAY JOB IN TV, ELECTRONICS, RADIO. SEND COUPON BELOW TODAY.**

APPROVED FOR  
VETERANS  
AND  
NON-VETERANS

## NATIONAL SCHOOLS

4000 S. FIGUEROA ST., LOS ANGELES 37, CALIF.

187 N. LA SALLE ST., CHICAGO 1, ILL.

IN CANADA: 811 W. Hastings St., Vancouver, B. C.

### NATIONAL SCHOOLS

TECHNICAL TRADE TRAINING SINCE 1905  
Los Angeles, California

GET FAST SERVICE—MAIL NOW TO OFFICE NEAREST YOU!

NATIONAL SCHOOLS, DEPT. RH-76

4000 S. FIGUEROA ST. OR 187 N. LA SALLE ST.  
LOS ANGELES 37, CALIF. CHICAGO 1, ILL.

Rush free TV-Radio "Opportunity" Book and sample lesson. No salesman will call.

NAME \_\_\_\_\_ BIRTHDAY \_\_\_\_\_ 19\_\_

ADDRESS \_\_\_\_\_

CITY \_\_\_\_\_ ZONE \_\_\_\_\_ STATE \_\_\_\_\_

VETERANS: Give Date of Discharge \_\_\_\_\_

**FREE!**

Fully illustrated "CAREER" BOOK in TV, Radio, Electronics. AND actual Sample Lesson—yours at no cost, no obligation SEND COUPON NOW—TODAY!



ONE SPEAKER  
THE NORELCO

*\*F.R.S.\**

*covers the audio  
frequency range*

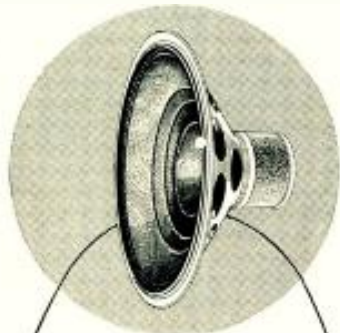

In a single twin-cone design—Norelco Full Resonance Speakers provide quality equal to most elaborate multi-unit sound systems.

Both high range and low range cones are operated by one magnet and one voice coil. Cones are always in phase and operate in harmony. Coupling designs give unexcelled spatial distribution throughout entire audio-frequency range.

Priced from \$59.98 to \$6.75 in all standard impedances and sizes from 12 inches to 5 inches.



ADD TO... and improve any sound system with *Norelco*<sup>®</sup>  
\*FULL RESONANCE SPEAKERS



Send to Dept. G7 for more details

North American Philips Co., Inc.  
100 East 42nd Street  
New York 17, N. Y.

# Within the Industry

**WILLIAM T. WARRENDER**, manager of the tube plant of *RCA Tube Division* at Marion, Indiana, has been appointed general manager of the recently-created *RCA Components Division*, with headquarters at Camden, N. J.



Mr. Warrender entered the electronics field in 1925. After 11 years as factory engineer with several tube manufacturing firms he joined *RCA* in 1936 at Harrison. A year later, he was transferred to the company's Indianapolis factory with responsibilities that included factory engineering and production control. In 1942 he was made superintendent of production and was named department manager in 1944.

He became manager of the Marion plant when *RCA* acquired the property in 1949.

\* \* \*

**SHURE BROTHERS, INC.** has moved into a new building located at 222 Hartrey Avenue in Evanston, Illinois. The million-dollar plant was planned and custom-built for maximum efficiency in the research, development, and manufacturing of microphones, phono cartridges, magnetic tape recording heads, and other acoustical electronic products . . . **SNYDER ANT-ENGINEERS, INC.** has opened a warehouse at 2724 Leonis Boulevard in Los Angeles to serve the West Coast area customers for *Snyder* antennas . . .

**ARROW ELECTRONICS, INC.** has moved its industrial department to larger quarters at 525 Jericho Turnpike, Mineola, Long Island. The new location provides over 117,000 cubic feet of warehouse space . . . **MINNEAPOLIS-HONEYWELL REGULATOR COMPANY** is moving its transistor division from Minneapolis to the Boston area . . .

**CLAREMONT TUBE CORPORATION** has established a picture tube warehouse at 1600 W. Luzerne Street, Philadelphia . . . **SANDS ASSOCIATES, INC.** has opened a new office in Palo Alto at 535 Ramona Street . . . **ORRADIO INDUSTRIES** is building the nation's first plant designed expressly for the manufacture of magnetic recording tape for sound-and-color TV and electronic brain computers. The \$300,000 plant will increase the Opelika, Alabama, firm's capacity by 400 per-cent. Completion is scheduled for October . . .

**AUDIOFAX ASSOCIATES, INCORPORATED**, engineering design service organization for the professional audio field, has recently moved its laboratory and store to Stony Brook, Long Island, New

York . . . **B & R ELECTRONICS CO.** and **ELECTRONIC CREATIONS CO., INC.** have moved their offices and factories to a new plant at 1178 East 180th Street, New York, N. Y. The 30,000 square foot plant will enable the firms to increase production on their lines of phonographs, radios, record players, etc. . . . **TRANSITRON, INC.** has moved its operations from New York to a modern 100,000 square foot plant in Manchester, New Hampshire . . . The Semiconductor Sales Department of **RADIO RECEPTOR COMPANY, INC.** has moved to 240 Wythe Avenue in Brooklyn, N. Y. . . . **SUPREME PUBLICATIONS** has closed its Chicago office and consolidated operations at its warehouse at 416 W. Huron Street in Chicago and at its Highland Park facilities . . . **GENERAL PRECISION LABORATORY INCORPORATED** has broken ground for a 23,200 square foot plant at Pleasantville, New York, to house its environmental test laboratory. The building is expected to be in operation late this year.

\* \* \*

**SIDNEY HARMAN**, president of *Harman-Kardon, Inc.*, has been elected chairman of the Sales Managers Club, succeeding Charles Golenpaul, vice-president of *Aerovox Corporation*.



Harry Estersohn of the *Jerrold Electronics Corp.*, Philadelphia, was elected vice-chairman. Walter Jablon, *Presto Recording Corp.*, was elected secretary-treasurer.

The Sales Managers Club was organized in 1937 and has operated as the electronics manufacturers' trade association without interruption for almost 20 years. It is one of the three national organizations which sponsor the annual Radio Parts and Electronic Equipment Show held in Chicago each May.

\* \* \*

**JAMES M. SKINNER, JR.** has been elected president of *Philco Corporation*, succeeding **JAMES H. CARMINE**, who retired recently . . . **SAUL J. WHITE** has joined *Racon Electric Co., Inc.*, as chief engineer. He was formerly with *University Loudspeakers* . . . **JOE C. HARMONY** has been named manager of receiving tube operations at *CBS-Hytron* . . . **FRANK C. ENGELHART**, president of *Kester Solder Company*, was recently honored on the occasion of his 75th birthday and his 47th anniversary with the company . . . **WILLIAM E. BARBOUR, JR.** was elected chairman of the board and **WILLIAM**

RADIO & TELEVISION NEWS

Something she'll be proud to own—



**FREE**

with your  
**SYLVANIA TUBE  
PURCHASES**

\*Earn the complete 54-piece set  
in the smart anti-tarnish chest

exclusive *Capri*

triple silverplate by Wm. A. Rogers

Watch the family's interest in your service skyrocket when you start working on the fabulous *Capri* triple silverplate. It's something anyone would be proud to own and Sylvania makes it possible for you to own it fast and free of extra cost with your purchases of "Silver Screen 85" picture tubes and Sylvania receiving tubes. You get one token for every two picture tubes or 25 receiving tubes.

When you need only 5 Sylvania tokens for a complete 4-piece setting, in no time at all you can earn a complete set of *Capri* triple silverplate.

*Capri* is an exclusive Wm. A. Rogers design of Oneida Limited, Silversmiths.

\*Get started on your *Capri* triple silverplate right away. It's an exclusive, offered only by your Sylvania Distributor. Call him today.



**\*Only 5 tokens for this 4-piece  
place setting.**

**You get one token for every two  
picture tubes or 25 receiving  
tubes.**



SYLVANIA ELECTRIC PRODUCTS INC.  
1740 Broadway, New York 19, N. Y.  
In Canada: Sylvania Electric (Canada) Ltd.,  
University Tower Bldg., Montreal

 **SYLVANIA®**

LIGHTING • RADIO • ELECTRONICS • TELEVISION • ATOMIC ENERGY



# BEST FOR COLOR TEST!



**MODEL 617  
3" OSCILLOSCOPE**

The most for your scope dollar. Flat-face CRT gives edge-to-edge accuracy... laboratory precision *plus* field ruggedness. And at your electronic jobber, it's just... \$269.50.

There's just one way to test the new color TV sets... **WITH NTSC COLOR PATTERN.** That's what Hycon's Model 616 Color Bar/Dot Generator offers... *all* standard colors, sequences and patterns easily selected and graphically shown *in actual color* right on the control panel. For color TV, get ready... **GET HYCON!**

*"Where Accuracy Counts"*  
**Hycon ELECTRONICS, INC.**  
A Subsidiary of Hycon Mfg. Company  
321 SOUTH ARROYO PARKWAY  
PASADENA, CALIFORNIA

**MAIL,**  
please,  
for Catalogs  
**616 and 617**

HYCON ELECTRONICS, INC. Dept. U  
P.O. Box 749 Pasadena, California  
Please send me the new model 616 and 617 catalogs.

Name \_\_\_\_\_  
Address \_\_\_\_\_  
City \_\_\_\_\_ State \_\_\_\_\_

**O. FAXON** was named president of *Tracerlab, Inc.* by the board of directors... **STERLING M. GARDNER**, founder of the *Gardner Electric Manufacturing Co.*, passed away recently in California. He was 70 years old... **WILLIAM A. SHAW** has been named sales manager of *Hallcrafters* home radio and television department. He has been with the firm for over ten years, most recently as national servicing manager... **ALBERT COUMONT** has joined *Sprague Products Company* as assistant to the president. He recently resigned as service coordinator of the RETMA... **FRANK APPLE** is the new advertising manager of *Centralab*... **WILLIAM B. DEAN** has been named president of *New England Industrial Center* in Needham Heights, Mass. He was formerly general manager of the industrial department of *DeMambro Radio Supply Co., Inc.* of Boston... **DR. ROBERT B. CORBY** has been appointed to the engineering staff of *Trio Laboratories, Inc.*... *Emerson Radio and Phonograph Corporation* has named **HARRY SCHECTER** to the post of vice-president in charge of distribution. He was formerly with *CBS-Columbia*... **MATTHEW N. CINELLI** has been appointed manager of quality control for the television-radio division of *Westinghouse*. He will make his headquarters in Metuchen, N. J.... **DR. ALLEN M. PETERSON** will head the newly-formed special techniques group in Stanford Research Institute's Engineering Division... **DAVID SOLOMON** has been named cooperative advertising manager for *CBS-Columbia*. He will be responsible for the planning, operation, and administration of the firm's national distributor cooperative advertising program in all media... **CHARLES M. SCHWAB** has been named general manager of the Puerto Rico plant of *Philips Control Corp.*, Joliet, Illinois, manufacturer of relays, solenoids, and control devices.

\* \* \*  
**HAROLD H. KNUBBE**, director of engineering for *CBS-Columbia*, has been promoted to the post of director in charge of all engineering and developmental activities at the company.



In his new post, Mr. Knubbe will supervise radio, black-and-white TV, color television, and industrial electronic engineering activities. He has been active in the electronics industry for the past twenty-four years. Before joining the company in 1952, he was chief engineer for *Sparton*. He was also associated with *General Instrument Corporation* and the *Detrola Radio Corporation*, among other electronic firms.

\* \* \*  
**BAIRD ASSOCIATES, INC.** and **ATOMIC INSTRUMENT COMPANY**, both of Cambridge, Mass., have merged in order to take maximum advantage of produc-



**who sells**  
.....  
**Mrs. America?**  
.....

**Garry Moore, that's who!**

He sells her because she likes him and has confidence in him. Nearly five million of her watch and listen to him weekdays on the CBS



Television Network. She *believes* what Garry says about his sponsors' products. And she buys them.

As a CBS tube dealer, you . . . yes, you . . . are one of Garry Moore's sponsors. He tells your customers that there are no better tubes made than your CBS tubes, and that they have the Good Housekeeping Guaranty Seal. He also tells the ladies about your technical training and equipment, and why they can rely on your expert service.

So remember, when you call at Mrs. America's home to repair her TV set, you . . . and CBS tubes . . . are welcome because Garry Moore has already convinced her that she can have confidence in both you and CBS tubes.



**CBS-HYTRON**

Danvers, Massachusetts

A Division of Columbia Broadcasting System, Inc.





**SAD?**

because you  
weren't able  
to get your

**1956 *Radio Electronic* MASTER**

Sorry you were disappointed. In many areas, there just weren't enough MASTERS to meet the demand.

But — cheer up. If you act fast, we can help you get your industry-wide buying guide. We've located several distributors with extras on hand.

And what's more . . . you'll only pay the \$2.95 distributor price instead of the regular \$7.50.

- 100,000 items
- Complete descriptions
- Specifications—Prices
- 11,000 illustrations
- 8 x 11", 6 lbs.
- 350 mfrs.

*So send your coupon now . . . first-come — first-served.*

**1450-Page Buying Guide . . .** helps you shop before you buy. The supermarket pages of The MASTER enable you to compare specs and prices first — then buy and save.

**A Gold Mine of Facts . . .** on all the latest products and models with changes in specs. It's all in The MASTER catalog file of the electronic parts industry.



**MAIL COUPON NOW!**

UNITED CATALOG PUBLISHERS, INC., 110 LAFAYETTE ST., NEW YORK 13, N. Y.  
*Here's my \$2.95. Please rush me the 1956 MASTER, Official Buying Guide of the Electronic Parts and Equipment Industry.*

Name.....

Address.....

City..... Zone..... State.....

RN-7

tion and sales efficiencies resulting from such an operation . . . **AMERICAN PHENOLIC CORPORATION** has changed its corporate name to **AMPHENOL ELECTRONICS CORPORATION** to retain the company's familiar tradename . . . **STROMBERG-CARLSON** has discontinued the manufacture of television receivers but will continue in the consumer products business with a complete line of radio-phonographs and high-fidelity equipment.

\* \* \*

**ANDRE G. CLAVIER**, vice-president and technical director of *Federal Telecommunication Laboratories*, Nutley, New Jersey, was recently honored for his pioneering efforts in microwave research.



The occasion marked the 25th anniversary of the historic experiment which took place on March 31, 1931, when a group of *I T & T* scientists established the world's first microwave circuit which extended across the English Channel between Dover and Calais.

Mr. Clavier was presented with a scale model of the parabolic antenna used during the historic demonstration. He joined the *I T & T* system in 1929 when he became affiliated with *Les Laboratoires Standards*, the company's Parisian subsidiary.

\* \* \*

**CROWELL-COLLIER PUBLISHING CO.** has purchased four TV stations and five radio stations subject to final approval of the FCC and the boards of directors of the various stations involved.

The new properties include television stations WTCN-TV (Minneapolis), WFBM-TV (Indianapolis), WOOD-TV (Grand Rapids), and KULA-TV (Honolulu) and radio stations WTCN (Minneapolis), WFBM (Indianapolis), WFDF (Flint), WOOD (Grand Rapids), and KULA (Honolulu).

\* \* \*

**HAROLD A. JONES** has been promoted to the post of national sales manager of *Motorola Communications and Electronics, Inc.* He was formerly executive assistant to the national sales manager, Eugene S. Goebel, who recently was named vice-president for market relations for the firm's division.



In his new capacity, Mr. Jones will have responsibility for implementing sales policy as well as executing sales planning and sales promotion. The function also includes sales training, advertising, and technical information services.

An electrical engineering graduate of Northwestern University, he joined the company in 1946 as a television receiver engineer.

-30-

World's Finest High Fidelity Tuners

# THE FISHER

■ Engineered for the professional, functionally designed for the home, THE FISHER Tuners are characterized by extreme sensitivity, micro-accurate tuning and precision workmanship throughout.

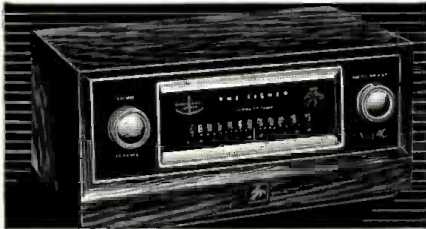

## FISHER FM TUNER • Model FM-40

■ A compact, beautifully designed instrument at moderate cost, for discriminating users. Stable circuitry and simplified controls make this remarkable tuner exceptionally easy to use. Meter for micro-accurate, center-of-channel tuning. Sensitivity: 3 microvolts for 20 db quieting. Supplied with folded dipole but can accommodate 300 or 72-ohm antenna systems. Drift-free circuit has three outputs: Cathode follower, Detector and Multiplex. Eight tubes, self-powered. Handsome brushed-brass panel for top appearance. SIZE: 12 $\frac{3}{4}$ " wide x 7 $\frac{1}{4}$ " deep x 4" high. WEIGHT: 15 pounds. *Mahogany or Blonde Cabinet Available.*

Chassis \$99.50 • Cabinet \$14.95



## FISHER FM TUNER • Model FM-80

■ Equipped with *two meters*, the FM-80 outperforms any existing FM tuner. Combines extreme sensitivity, flexibility, and micro-accurate tuning. Unusually compact, exceptionally engineered chassis. Armstrong system, two IF stages, dual limiters, cascode RF stage. *Full limiting* even on signals as weak as *one microvolt!* 72 and 300-ohm antenna inputs. *Completely shielded* and shock-mounted. **THREE CONTROLS:** Variable AFC/Line Switch, Sensitivity, and Station Selector. Two bridged outputs, cathode follower type. 11 tubes. Brushed-brass control panel. Self-powered. SIZE: 12 $\frac{3}{4}$ " x 7 $\frac{1}{4}$ " x 4" high. WEIGHT: 15 pounds. *Mahogany or Blonde Cabinet.*

Chassis \$139.50 • Cabinet \$14.95



## FISHER AM TUNER • Model AM-80

■ This is the high quality AM counterpart of the famous FM-80 Tuner described above. It combines the pulling power of a professional communications receiver with the broad tuning necessary for high fidelity reception. Designed to rigid standards, featuring a tuning meter for micro-accurate station selection. Three-position adjustable band width. Extreme sensitivity—less than *one microvolt* produces maximum output! Elusive and distant stations are brought in with ease. Three inputs, cathode follower output. Eight tubes. Self-powered. SIZE: 12 $\frac{3}{4}$ " wide x 7 $\frac{1}{4}$ " deep x 4" high. WEIGHT: 15 pounds. *Mahogany or Blonde Cabinet Available.*

Chassis \$139.50 • Cabinet \$14.95



## FISHER FM-AM TUNER • Model 80-R

■ Acclaimed everywhere as the finest FM-AM tuner available. Works where others fail! Has two meters for micro-accurate tuning, features extreme sensitivity—1.5 microvolts for 20 db quieting! Adjustable AFC and AM selectivity, separate FM and AM front ends. Shock-mounted chassis, super-smooth flywheel tuning. Completely shielded construction used throughout. Response within 0.5 db from 20 to 20,000 cycles. Distortion below 0.04% for 1 volt output. Cathode follower and Multiplex outputs. Handsome, brushed-brass control panel. SIZE: 12 $\frac{3}{4}$ " wide x 8 $\frac{3}{4}$ " deep x 4" high. WEIGHT: 16 pounds. *Mahogany or Blonde Cabinet Available.*

Chassis \$169.50 • Cabinet \$17.95



## FISHER FM-AM TUNER • Model 80-T

With Preamplifier and Complete Audio Controls

■ Unequaled among FM-AM tuners with controls. Model 80-T is identical to Model 80-R but has built-in Preamplifier-Equalizer. It uses **TWO meters**, for center-of-channel indication and signal strength. Extreme sensitivity—1.5 microvolts for 20 db quieting. Adjustable AFC, adjustable AM selectivity. Designed with separate FM and AM front ends. Response 20 to 20,000 cycles, within 0.5 db. At one volt output distortion is less than 0.4%. Contains phono and tape-head preamplifier, with full equalization controls. Three inputs, two outputs, including Multiplex. 16 tubes. **EIGHT CONTROLS:** Selector, Variable AFC/Line Switch, Station Selector, Bass, Treble, Equalization, Volume, 4-Position Loudness Balance. SIZE: 12 $\frac{3}{4}$ " wide x 8 $\frac{3}{4}$ " deep x 6" high. WEIGHT: 21 pounds. *Mahogany or Blonde Cabinet Available.*

Chassis \$199.50 • Cabinet \$17.95

*Prices Slightly Higher in the West*

WRITE TODAY FOR COMPLETE SPECIFICATIONS

**FISHER RADIO CORPORATION • 21-23 44th DRIVE • L. I. CITY • N. Y.**

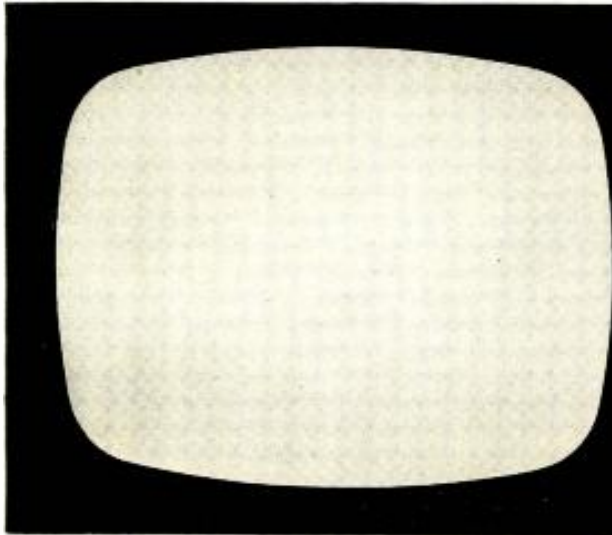

# how long would it take you to solve this service problem?

## SYMPTOM:

No picture is obtained. Sound is distorted. Raster is okay.

There's no telling how long it might take to solve this problem with hit-or-miss methods or incomplete service data. With a PHOTOFAC Folder by your side, the job takes just minutes. Here's why:

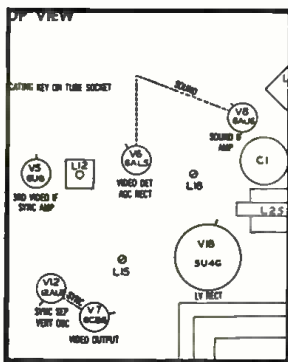

1. In just seconds, you locate the tubes most likely to cause this symptom by referring to the Tube Placement Chart\* and Tube Failure Check Chart\* you'll always find in each PHOTOFAC TV Folder.

In this case the trouble wasn't caused by tube failure. So checking further...

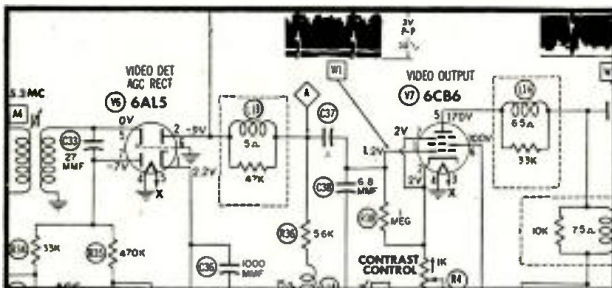

\*One of 32 features found exclusively in PHOTOFAC—the world's finest service data—the data that gives you the most for your money.

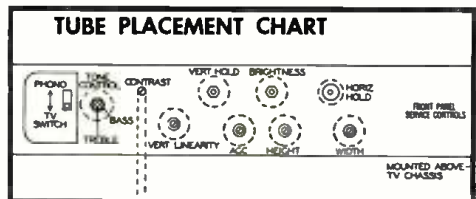

2. Adjustment of the AGC Control caused a weak picture to appear. Operation of the contrast control had no effect (control identification and location appear right on the Tube Placement Chart\*). Next logical step:

3. In just seconds, you refer to the Video and AGC circuits on the Standard Notation Schematic\* featured exclusively in PHOTOFAC Folders. (Circuits are always laid out in the same uniform manner—easy to locate—easy to trace.) In a matter of minutes, you check waveforms and/or voltages—they're right on the schematic. In those same few minutes, you pinpoint the trouble. You make a resistance check using the handy Resistance Chart\* and you have the answer to your problem in this case history: A cold solder connection at the center lug of the Contrast control.



### MONEY BACK GUARANTEE!

Got a tough repair? Try this—at Howard W. Sams' own risk: see your Parts Distributor and buy the proper PHOTOFAC Folder Set covering the receiver. Then use it on the actual repair. If PHOTOFAC doesn't save you time, doesn't make the job easier and more profitable for you, Howard W. Sams wants you to return the complete Folder Set direct to him and he'll refund your purchase price promptly. GET THE PROOF FOR YOURSELF—TRY PHOTOFAC NOW!

free



Send for Sams' INDEX TO PHOTOFAC FOLDERS—your guide to virtually any receiver model ever to come into your shop; helps you locate the proper PHOTOFAC Folder you need to solve any service problem on any model. You'll want this valuable reference guide. Send coupon now.

### HOWARD W. SAMs & CO., INC.

Howard W. Sams & Co., Inc.  
2203 E. 46th St., Indianapolis 5, Ind.

- Send FREE Index to PHOTOFAC Folders
- I am a Service Technician: \_\_\_full time; \_\_\_part time.
- Student. Other: \_\_\_\_\_

Shop Name:.....

Attn.:.....

Address:.....

City.....Zone....State.....



**NEW! COLOR and Black-&-White  
LAB & TV 5" OSCILLOSCOPE #460  
KIT \$79.95. Wired \$129.50**

The FINEST professional 5 mc wide-band scope value. Ideal for research, h-f & complex waves, plus Color & Monochrome TV servicing. Flat from DC to 3.58 mc  $\pm 1$  db (color burst freq.), flat DC to 4.5 mc  $+1, -3$  db. Vert. sens. 25 rms mv/in. Vert. Z 3 megs. Has the following outstanding features not found in scopes up to several times its price, kit or wired:

**VERTICAL AMPLIFIER:** direct-coupled (DC) thruout to eliminate l-f phase shift; push-pull thruout for negligible distortion; K-follower coupling between push-pull pentode stages for extended h-f resp. (minimizes h-f phase shift, extends useful resp. to 10 mc); full-screen undistorted vert. defl; 4-step freq-compensated decade step attenuator up to 1000:1. **SWEEP CIRCUIT:** perfectly linear sweeps, 10 cps — 100 kc (ext. cap. for down to 1 cps); pre-set TV vert. & hor. positions (30 & 7875 cps); automatic sync. ampl. & limiter eliminates sync amplitude adj. **PLUS:** direct or cap. coupling; bal. or unbal. inputs; edge-lit engraved lucite graph screen; dimmer; anti-glare filter; bezel fits sid photo equip. **OTHER IMPORTANT FEATURES:** High intensity trace CRT. Finest sq. wave resp. (.06 usec rise time). Push-pull hor. ampl., flat to 400 kc, sens. 0.6 rms mv/in. Built-in voltage calibration. Intensity mod. Sawtooth & 60 cps outputs. Astigmatism control. Retrace blank-

ing. Instant, drift-free full-screen vert. positioning & 2X full-screen hor. positioning. Bal., cal., astig. adj. externally accessible. 5U1 CRT, 2-6AU8, 2-6CB6, 1-12AU7A, 2-6J6, 1-6AX5, 1-1V2. Deep-etched satin aluminum panel, rugged grey wrinkle steel cabinet. Designed for easy building at home with no special equipment. 13" x 8 1/2" x 16". 30 lbs.

**SCOPE DIRECT PROBE\* = PD:** KIT \$2.75. Wired \$3.95. Eliminates stray-pick-up & signal re-radiation.

**SCOPE DEMODULATOR PROBE\* = PSD:** KIT \$3.75. Wired \$5.75. Demodulates AM carriers between 150 kc and 250 mc.

**SCOPE LOW CAPACITY PROBE\* = PLC:** KIT \$3.75. Wired \$5.75. For signal tracing in high frequency, high impedance & wide-band circuits (as in TV) without distortion from overloading or frequency discrimination.



**150 kc to 435 mc  
with ONE generator!**

**New! RF SIGNAL GENERATOR #324  
KIT \$26.95. Wired \$39.95**

for **COLOR** and Monochrome TV servicing

New wide-range, stable generator — better value than generators selling at 2 or 3 times its cost! Ideal for: IF-RF alignment, signal tracing & trouble-shooting of TV, FM & AM sets; marker gen.; 400 cps audio testing; lab. work. **6 fund. ranges:** 150-400 kc, 400-1200 kc, 1.2-3.5 mc, 3.5-11 mc, 11-37 mc, 37-145 mc; 1 harmonic band 111-435 mc. **Freq. accurate to  $\pm 1.5\%$ ;** 6:1 vernier tuning & excellent spread at most important alignment freqs. Etched tuning dial, plexiglass windows, edge-lit hairlines. Colpitts RF osc., directly plate-modulated by K-follower for improved mod. Variable depth of int. mod. 0-50% by 400 cps Colpitts osc. Variable gain ext. mod. amplifier: only 3.0 volts needed for 30% mod. Turret-mounted coils slug-tuned for max. accuracy. Fine & Coarse (3-step) RF attenuators. RF output 100,000 uv; AF sine wave output to 10 volts. 50-ohm output Z. 5-way jack-top binding posts for AF in/out; coaxial connector & shielded cable for RF out. Tubes: 12AU7, 12AV7, selenium rectifier; xfmr-operated. Deep-etched satin aluminum panel, rugged grey wrinkle steel cabinet. 8" x 10" x 4 3/4". 10 lbs.



for **COLOR** and Monochrome TV servicing

**New! PEAK-to-PEAK VTVM #232  
& UNI-PROBE (pat. pend.)  
KIT \$29.95. Wired \$49.95**

**UNI-PROBE:** exclusive with EICO! Terrific time-saver! Only 1 probe performs all functions—a half-turn of probe-tip selects DC or AC-Ohms.

The new leader in professional peak-to-peak VTVMs. Latest circuitry, high sensitivity & precision, wide ranges & versatility. Calibration without removing from cabinet. New balanced bridge circuit. High Z input for negligible loading. 4 1/2" meter, can't-burn-out circuit. 7 non-skip ranges on every function. 4 functions: +DC Volts, —DC Volts, AC Volts, Ohms.

Uniform 3 to 1 scale ratio for extreme wide-range accuracy. Zero center. One zero-adj. for all functions & ranges. 1% precision ceramic multiplier resistors. Measure directly peak-to-peak voltage of complex & sine waves: 0-1, 14, 42, 140, 420, 1400, 4200. DC/RMS sine volts: 0-1.5, 5, 15, 50, 150, 500, 1500 (up to 30,000 v. with HVP probe, & 250 mc with PRF probe). Ohms: 0.2 ohms to 1000 megs. 12AU7, 6AL5, selenium rectifier; xfmr-operated. 8 1/2" x 5" x 5". Deep-etched satin aluminum panel, rugged grey wrinkle steel cabinet. 7 lbs.

**New! DELUXE PEAK-to-PEAK VTVM #249  
with 7 1/2" METER & UNI-PROBE (pat. pend.)  
KIT \$39.95. Wired \$59.95**

All the advanced & exclusive features of #232—PLUS the extra-convenience and readability of its big 7 1/2" meter. Your ideal bench instrument.

**VTVM RF PROBES\* #PRF-11 or PRF-25:** KIT \$3.75. Wired \$4.95. Accuracy  $\pm 10\%$ . Use with any 11 or 25 megohm VTVM.

**VTVM HV PROBE #HVP-2:** Wired \$4.95. Complete with multiplier resistor. Measures up to 30 kv with any VTVM or 20,000 ohms/volt VOM.



Calibration without removing from cabinet.

\*Only EICO Probes have all these features: fully shielded; rugged terminal board parts mounting; shock-mounted floating construction; swivel-action; color-coding; easy parts accessibility.



The specs are the proof...

**4 NEW BEST BUYS  
by EICO**

**COMPLETE  
with Preamplifier, Equalizer and Control Section  
New! 20-WATT Ultra-Linear Williamson-type HIGH FIDELITY AMPLIFIER #HF20  
KIT \$49.95. Wired \$79.95**

A low-cost, complete-facility amplifier of the highest quality that sets a new standard of performance at the price, kit or wired. Every detail, down to the etched, brushed solid brass control plate, is of the fine quality EICO is famous for.

Rated power output: 20 watts (34 w peak). IM distortion (60 cps: 6 kc/4:1) at rated power: 1.3%. Mid-band harmonic distortion at rated power: 0.3%. Maximum harmonic distortion between 20 and 20,000 cps at 1 db under rated power: approx. 1%. Power response (20w):  $\pm 0.5$  db 20-20,000 cps;  $\pm 1.5$  db 10-40,000 cps. Frequency response (1/4 w):  $\pm 0.5$  db 13-35,000 cps;  $\pm 1.5$  db 7-50,000 cps.

5 feedback equalizations for LP's & 78's including RIAA. Variable turnover feedback tone controls do not affect volume & permit large boosts or cuts at either end of audio spectrum with mid-freqs. unaffected. Loudness control & separate level set control on front panel. Low Z output to tape recorder. 4 hi-level switched inputs: tuner, tv, tape, auxiliary (xtal/ceramic phono or 2nd tuner); 2 low-level inputs for proper loading with all leading magnetic, FM & quality xtal cartridges. Hum bal. control. Extremely fine output transformer has interleaved windings, tight coupling, careful balancing & grain-oriented steel. 8 1/2" x 15" x 10". 24 lbs.

These amazing EICO values are NOW IN STOCK at your nearest distributor. Examine them side-by-side with ANY competitor. You'll see for yourself why indeed EICO is your BEST BUY. Fill out coupon on reverse page.



TURN PAGE FOR MORE EICO VALUES...

84 Withers Street, Brooklyn 11, New York

Prices 5% higher on West-Coast.

**the specs are  
the test that tells  
who's best!**

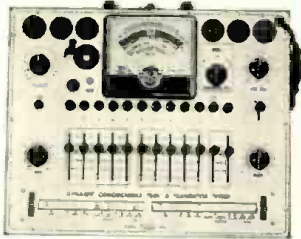

for COLOR & Monochrome  
TV servicing

**NEW! DYNAMIC  
CONDUCTANCE TUBE &  
TRANSISTOR TESTER #666  
KIT \$69.95 WIRED \$109.95**

Unexcelled testing thoroughness & accuracy. Checks transistor collector current & Beta using internal dc power supply. Tests all receiving tubes including subminiatures (& Color & Monochrome tv pic tubes with accessory adapter). Composite indication of mutual conductance, plate conductance, & peak emission. Simultaneous sel. of any 1 of 4 combinations of 3 plate, 3 screen, & 3 ranges of control grid voltage. Grid voltage variable over 3 ranges with 5% accurate pot. New series-string voltages for 600, 450 & 300 ma types. 5 ranges meter sens. with 1% precision shunts & 5% accurate pot. 10 SIX-position lever switches for free-point connection of every tube pin or cap. 10 pushbuttons for rapid insert of any tube element in leakage circuit & speedy sel. of individual tube sections. Direct reading of inter-element leakage in ohms. New gear-driven rollchart. Steel case with cover & handle. Sensitive 200 ua meter.

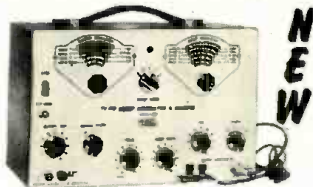

**NEW**

for COLOR & Monochrome  
TV servicing  
**TV-FM SWEEP GENERATOR  
& MARKER #368  
KIT \$69.95 WIRED \$119.95**

The FINEST service instrument of this type ever offered in either kit or wired form at ANY price! Outstanding ease & accuracy in FM & TV (including Color) alignment. Entirely electronic sweep circuit with accurately biased Incredutor: superb linearity on both sides of selected center freq. Newly-designed AGC circuit automatically adjusts osc. for max. output on each band with min. amplitude variations. Sweep gen. range 3-216 mc in 5 OVERLAPPING FUND. BANDS. Sweep width continuously variable from 0-3 mc lowest max. deviation to 0-30 mc highest max. deviation. Variable marker gen. range from 5-75 mc in 2 FUND. BANDS plus a calibrated harmonic band (54-225 mc). Variable marker calibrated with int. xtal marker gen. 4.5 mc xtal included. Ext. marker provision. Double pi line filter. Edge-lit hairlines eliminate parallax.

Turn page for other EICO ad



**FREE 1956  
EICO CATALOG!**  
Tells you how to SAVE 50% on  
your test equipment costs!

 <p><b>TUBE TESTER #625</b> KIT \$34.95 Wired \$49.95</p> <ul style="list-style-type: none"> <li>tests 600 mil series string type tubes</li> <li>illuminated roll-chart</li> </ul> <p>Pix Tube Test Adapter .....\$4.50</p>	<p><b>New! GEIGER COUNTER #803</b> KIT \$19.95      Wired \$29.95</p>  <p>(see batteries) Professional, all-electronic, sensitive rugged—at lowest cost! Indicates by neon lamp &amp; headphone clicks.</p>	 <p><b>5" PUSH-PULL OSCILLOSCOPE #425</b> KIT \$44.95 Wired \$79.95</p>  <p><b>7" PUSH-PULL OSCILLOSCOPE #470</b> KIT \$79.95 Wired \$129.50</p>
 <p><b>VACUUM TUBE VOLTMETER #221</b> KIT \$25.95 Wired \$39.95</p> <p><b>DELUXE VTVM : 214 (7 1/2" METER)</b> KIT \$34.95 Wired \$54.95</p>	 <p><b>RF SIGNAL GENERATOR #320</b> KIT \$19.95 Wired \$29.95</p> <p>150 kc-34 mc, calibrated harmonics to 102 mc. Pure or mod. RF, &amp; Colpitts osc. 400 cps sine outputs.</p>	<p><b>NEW! UTILITY TESTER #540</b> KIT \$12.95 Wired \$15.95</p> <p>Multi-range ac/dc voltmeter, ammeter, ohmmeter, wattmeter, leakage checker for home &amp; auto repairs.</p>
 <p><b>#944 FLYBACK TRANSFORMER &amp; YOKE TESTER</b> KIT \$23.95 Wired \$34.95</p> <ul style="list-style-type: none"> <li>fast check all flybacks &amp; yokes in or out of set.</li> <li>spots even 1 shorted turn!</li> </ul>	 <p>Range 500 kc-228 mc on fund. Cont. sweep width control, 0-30 mc.</p> <p><b>TV/FM SWEEP GENERATOR #360</b> 5MC-4.5MC CRYSTAL .....\$3.95 ea.</p> <p>KIT \$34.95 Wired \$49.95</p>	 <p>1% accuracy on all 7 ranges. Range 75 kc-150 mc. Volt reg.</p> <p><b>DELUXE RF SIGNAL GENERATOR #315</b> KIT \$39.95 Wired \$59.95</p>
 <p>Sep. volt-meter &amp; ammeter</p> <p>KIT \$29.95 Wired \$38.95</p> <p><b>6V &amp; 12V BATTERY ELIMINATOR &amp; CHARGER #1050</b></p>	 <p>Sep. hi-gain RF &amp; lo-gain audio inputs. Special noise locator. Calibrated wattmeter.</p> <p>KIT \$24.95 Wired \$39.95</p> <p><b>DELUXE MULTI-SIGNAL TRACER #147</b></p>	 <p>Reads 0.5 ohms -500 megs, 10 mmd-5000 mfd power factor.</p> <p>KIT \$19.95 Wired \$29.95</p> <p><b>R-C BRIDGE &amp; R-C-L COMPARATOR #950B</b></p>
 <p><b>HI-FI PREAMPLIFIER #HF-6</b> KIT \$24.95 Wired \$37.95. With Power Supply: KIT \$29.95. Wired \$44.95</p> <p>Feedback circuitry thruout! Preamp-equalizer, tone controls, scratch &amp; rumble filters, K-follower output.</p>	 <p>20,000 Ohms/Volt MULTIMETER #565 KIT \$24.95 Wired \$29.95</p>  <p>1000 Ohms/Volt MULTIMETER #536 KIT \$12.90 Wired \$14.90</p>	<p><b>VTVM PROBES</b>      KIT      Wired</p> <p>Peak-to-Peak .....\$4.95      \$6.95</p> <p>RF .....\$3.75      \$4.95</p> <p>High Voltage Probe-1 .....\$6.95</p> <p>High Voltage Probe-2 .....\$4.95</p> <p><b>SCOPE PROBES</b></p> <p>Demodulator .....\$3.75      \$5.75</p> <p>Direct .....\$2.75      \$3.95</p> <p>Low Capacity .....\$3.75      \$5.75</p>

For FREE 1956 catalog, mail coupon NOW!



84 Withers St. • Brooklyn 11, N. Y.

Prices 5% higher on West coast and subject to change without notice. © 56

EICO, 84 Withers Street R-7  
Brooklyn 11, New York

Send FREE 1956 Catalog and name of neighborhood EICO jobber.

Name.....  
Home Address.....  
City.....Zone.....State.....  
Occupation.....

1945 to 1955: a decade of Know-How & Value Leadership in Kits & Instruments—over 1/2 million sold to date!

# PORTABLE TV

By  
**WALTER H. BUCHSBAUM**  
Television Consultant  
RADIO & TELEVISION NEWS



Portable TV sets can be used anywhere in the house. They are easy to carry and most of them, like the Admiral shown here, will come equipped with an indoor antenna.

*This is the hottest item on the black-and-white TV market.*

*Why are they popular and what are their repair problems?*

WITH well over 33 million TV receivers in American homes, the major set manufacturers have suddenly decided to mass produce small, low-cost receivers with screen sizes reminiscent of the early days of TV. They are doing this despite the emphasis in TV sales of replacing the early small-screen sets with 21-inch receivers. Yet, the appearance of the new small-screen receivers is the result of careful market studies and tests by the leaders of the TV industry who found that a market for "personal" or portable TV sets exists in areas receiving several channels. The program preferences of various members of the family, especially the younger set, often lead to the decision to buy a second set. Men or women living alone, bedridden people, travelers, and a host of others apparently see no great merit in buying a large-screen set if they can get a cheaper, small-screen set which is just large enough for close-up viewing.

Assuming that the major manufacturers are correct in their estimate of the demand for small, low-cost TV sets, how will this development affect the service operator?

While no one can foretell the full impact of this development, certain new factors can safely be predicted. For one, the customer will object to the cost of repairing these sets even more than he does for his present large-screen set since the original purchase price for the portable model is usually lower. This is reminiscent of the prewar radio servicing days when the customer often refused to pay a legitimate \$6.00 repair charge on the grounds that the whole set had cost only \$9.95. Yet, the actual service costs for a small-screen portable set may be higher than for a more elaborate console. The reasons are that the portable may get rougher handling, have less expensive components, develop more heat per volume, and be subject to great variations in temperature.

Most of these small-screen sets will probably not require installation by a technician since, if it is used as a second or third set in the home, the portable

will be connected to an existing antenna and only a coupler is needed. In many other instances, the set will be operating from an indoor antenna. It is doubtful that many of these sets will be sold in weak signal areas because most portable sets do not have the full gain-bandwidth capability usually found in larger models.

### Design Features

Although it may appear that the

new small-screen TV receivers are really portable, they are actually only transportable, since they will not play while being carried by the viewer as is the case with portable radios. At the time of writing, no battery powered TV set has been put on the market.

Power supplies vary greatly among the new portable receivers. Some sets, like the *Setchell Carlson* model shown in Fig. 2, have regular power trans-

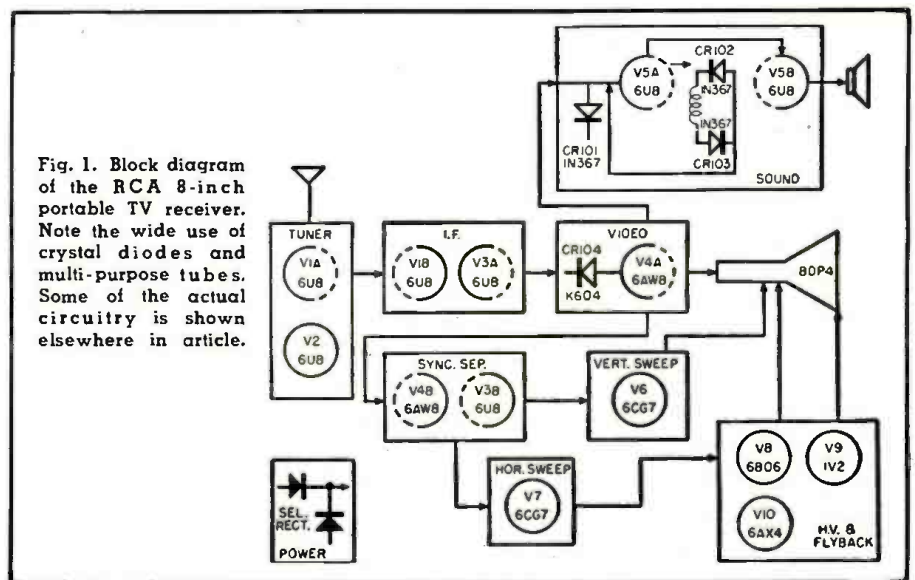

Fig. 1. Block diagram of the RCA 8-inch portable TV receiver. Note the wide use of crystal diodes and multi-purpose tubes. Some of the actual circuitry is shown elsewhere in article.

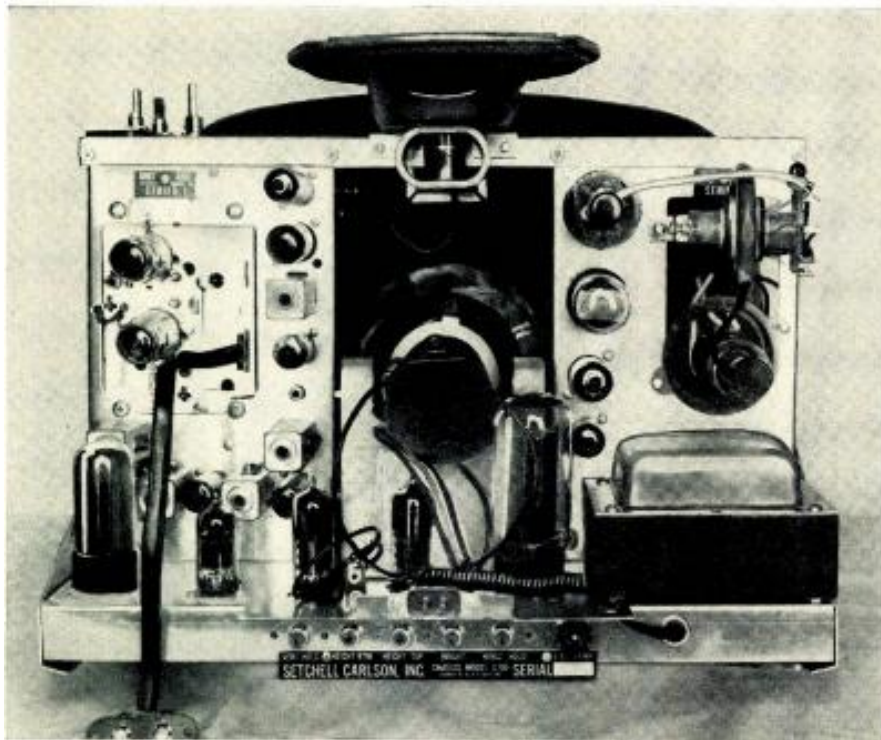

Fig. 2. Interior of the Setchell Carlson portable TV set shown in Fig. 7. Note the use of a power transformer and two-part chassis, horizontal and vertical.

formers and 5U4 rectifier tubes. Others, like the *G-E* model shown in Fig. 7, use a series heater, transformerless, voltage-doubler type power supply with tubes of the type having a controlled warm-up time. The *RCA* 8-inch receiver shown in Fig. 7 uses both a power transformer with 6.3-volt heater tubes and a selenium voltage doubler as "B+" source. It would seem from these examples that the design of the power supply section is largely a matter of available parts and relative cost, and these vary between manufacturers.

One design feature, common to all lightweight TV receivers, is the widespread use of multiple purpose tubes. A typical example of this is in the *RCA* 8-PT-7030 series TV receivers which use only ten receiving tubes of which only the high-voltage rectifier, damper, and horizontal output tubes are single-function types. The block diagram of Fig. 1 shows how these ten tubes are arranged to perform the functions of 17 separate vacuum tubes. Note in particular the tuner and audio sections. A detailed discussion of the tuner circuit is presented in a later paragraph. The audio output tube is actually the triode section of the 6U8, which is sufficient in this application but not generally recommended as a power amplifier. The 6CG7 tubes used in the sweep sections are the 9-pin equivalents of the well-known 6SN7 dual triode.

It should be pointed out that in addition to the ten receiving tubes the receiver also uses four crystal diodes and two selenium rectifiers, the latter in the power supply. The crystal diodes are used in the conventional video detector application as well as in the unusual position as ratio detector and as clipper in the grid circuit of the audio limiter section.

The one almost universal feature among portable sets appears to be the use of vertical chassis. In some instances, as in the new *RCA* models, the chassis consists of two parts, one stacked vertically behind the other. Many receivers also make use of printed-wiring boards. In the *G-E* series "M" receivers, for example, the entire vertical chassis consists of printed-wiring boards with the components mounted towards the picture tube screen and the tubes accessible from the rear of the set. The printed-wiring assemblies are supported by the metal chassis which also holds the tube shields and other hardware.

Picture tubes used in the new portable receivers range from the conventional 17-inch size down to the new 8-inch rectangular types. While the 17- and 14-inch tubes usually use 70° deflection, most of the smaller ones, like the new 8-inch rectangular picture tube, use a 90° deflection angle and completely different deflection assemblies. Fig. 3 shows the adjustment points at the neck of the 8DP4 (the *RCA* 8-inch tube) and as can be seen here, this tube uses a short yoke, a centering ring assembly, and an ion

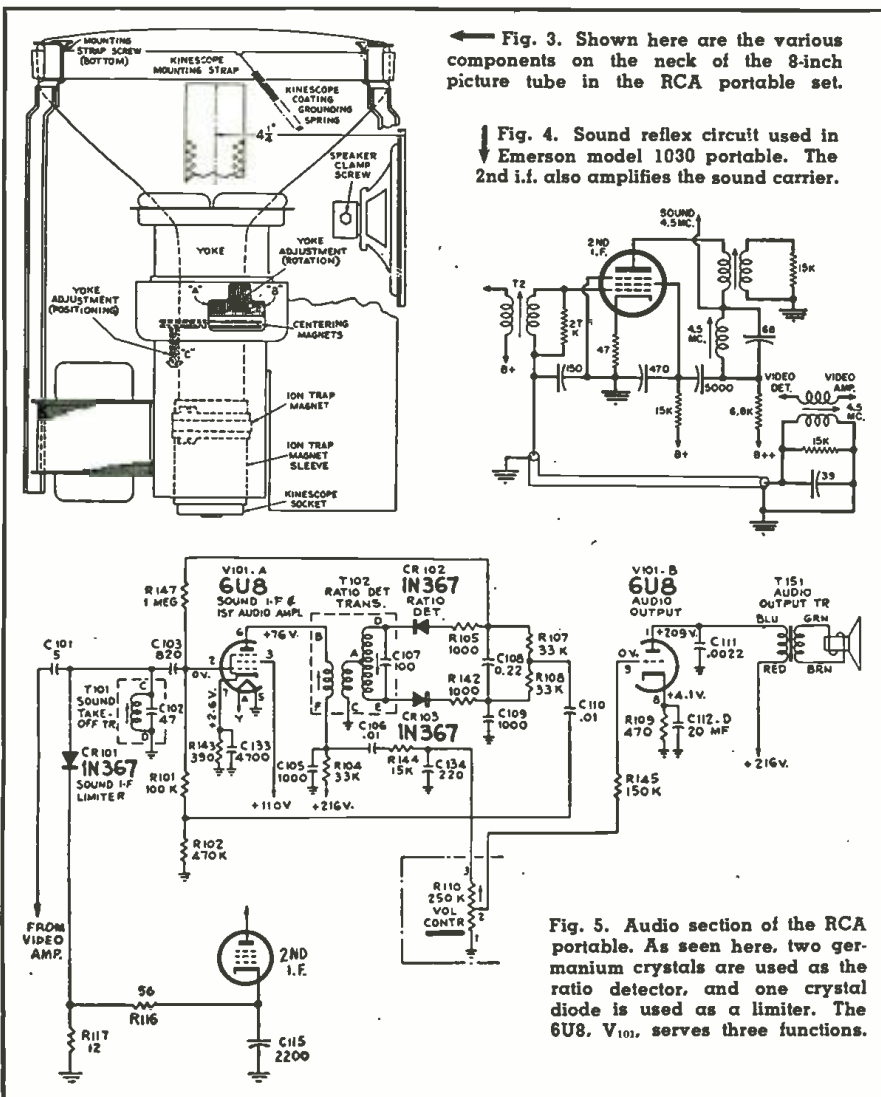

Fig. 3. Shown here are the various components on the neck of the 8-inch picture tube in the *RCA* portable set.

Fig. 4. Sound reflex circuit used in Emerson model 1030 portable. The 2nd i.f. also amplifies the sound carrier.

Fig. 5. Audio section of the *RCA* portable. As seen here, two germanium crystals are used as the ratio detector, and one crystal diode is used as a limiter. The 6U8,  $V_{101}$ , serves three functions.

trap, all covered by a metal shield. Focusing is accomplished by the low-voltage electrostatic system well known from older tube types.

In external appearance the common feature of all portable equipment is, naturally, the carrying handle and the extreme compactness of the cabinet. The cabinets are most frequently made of metal, particularly aluminum for lightness. Indoor antennas are furnished optionally. Sometimes a short wire is connected to the power cord via a capacitor. Such line cord antennas are not too satisfactory.

A novel feature of the RCA 8-inch receiver is shown in Fig. 7. A small stand supports the set on a "U"-shaped bracket permitting it to be rotated and tilted for the optimum viewing angle.

The loudspeaker is often placed at the top of the cabinet, occasionally at the sides and, in the Emerson portable, the speaker and controls are accessible by opening a small panel at the top. This panel serves both as a dustcover and as a reflector for the sound, improving the acoustics of this set somewhat.

### Circuit Features

Actually there are no radically new circuits in use in the new small-screen receivers. Only simplified circuits and novel component arrangements confront the technician and none of these is so different as to present any serious service problem. One of the novel arrangements is the sound reflex circuit used in the Emerson 1030 series models shown in Fig. 4. Here, the 4.5 mc. intercarrier sound signal is removed from the output of the video detector and, through a shielded wire, fed to the grid of the second i.f. amplifier, in series with the 41 mc. i.f. signal. At the plate of this stage there are two resonant circuits in series. One is tuned to a particular 41 mc. i.f. stagger frequency while the second network resonates at 4.5 mc. and serves as the output load for the sound carrier. This arrangement uses the 2nd i.f. amplifier for additional sound carrier amplification so that a substantial signal is presented to the sound limiter. The use of the second i.f. amplifier in

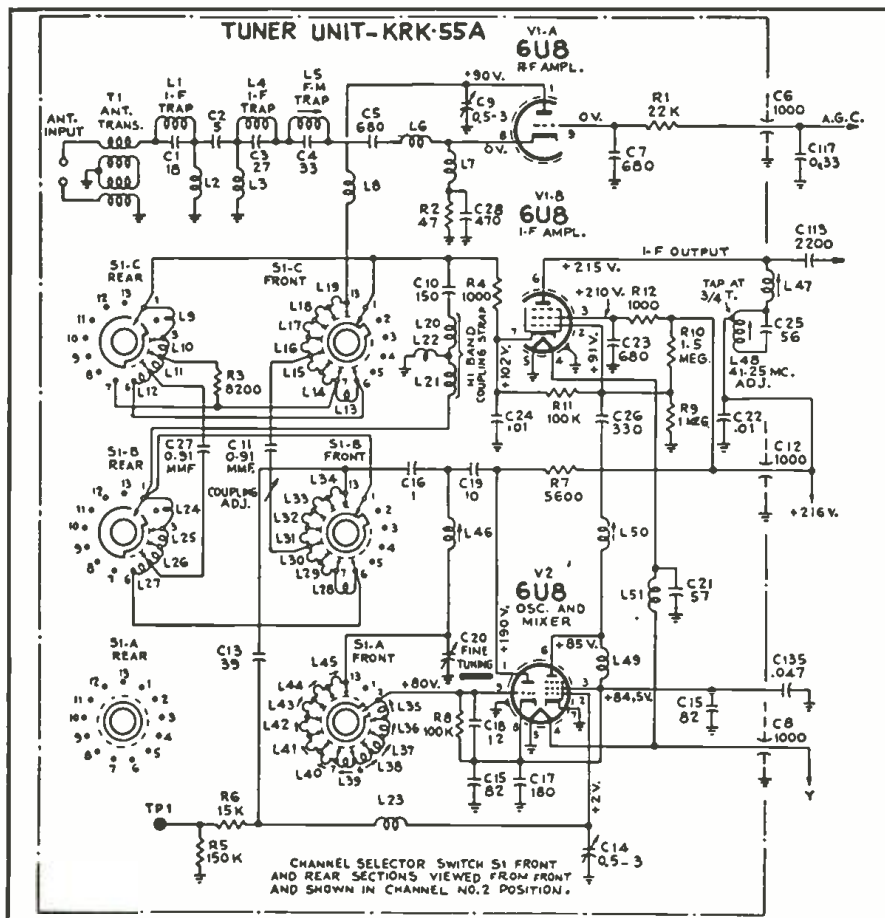

Fig. 6. Schematic diagram of the tuner used in the RCA portable showing how two 6U8's are used as r.f. amplifier, oscillator, mixer, and first i.f. amplifier.

this manner saves a tube and provides excellent intercarrier system performance.

Another circuit feature found in many portable TV receivers is the use of only two i.f. stages. This generally results in a compromise between bandwidth and gain which makes these sets a poor choice for a weak signal area. Of course, the smaller screen does not require as much picture detail and, therefore, some i.f. bandwidth reduction can be tolerated.

One method of saving tubes in the i.f. strip is shown in Fig. 6, the circuit

of the tuner used in the RCA 8-PT-7030 receiver. Here the two tubes in the tuner actually contain four separate sections. One tube serves as an oscillator and mixer while the triode of the other tube is used as a grounded-grid r.f. amplifier. This leaves the fourth section, a pentode, for operation as the first i.f. amplifier. Bypassing and shielding as well as alignment of this tuner and i.f. amplifier combination are slightly more critical than for conventional circuitry but the performance of this arrangement is satisfactory.

(Continued on page 127)

Fig. 7. Three recent portables are shown here; they are the RCA 8-inch model, the G-E 9-inch, and the Satchell Carlson.

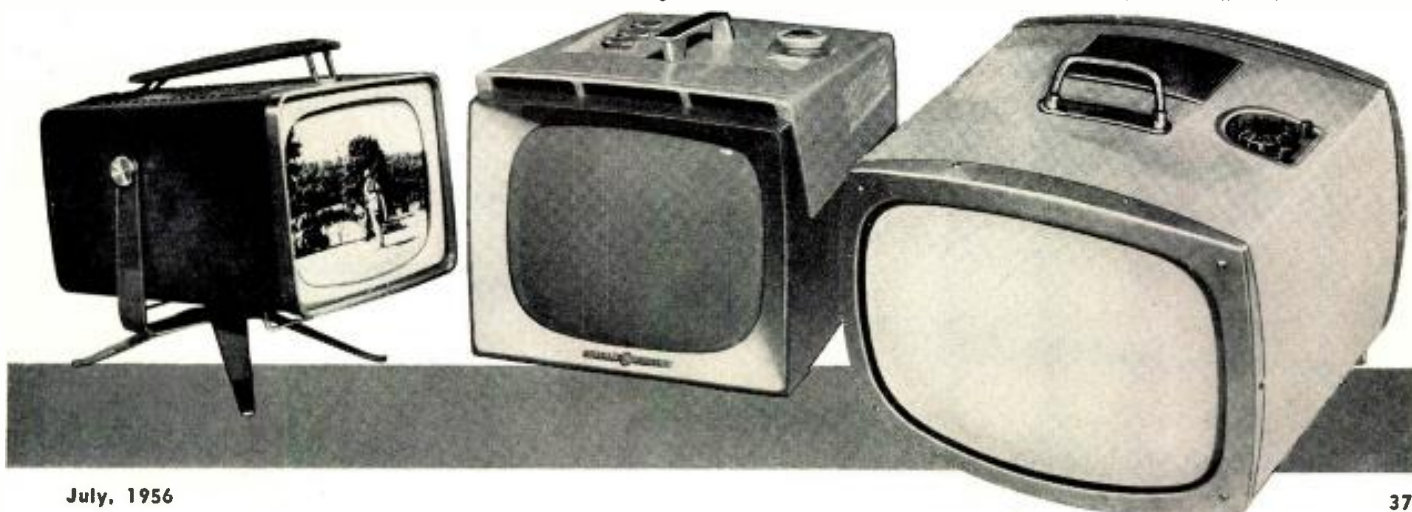

By JOSEPH H. STEINMETZ, W4YI

# Doing It the Easy Way

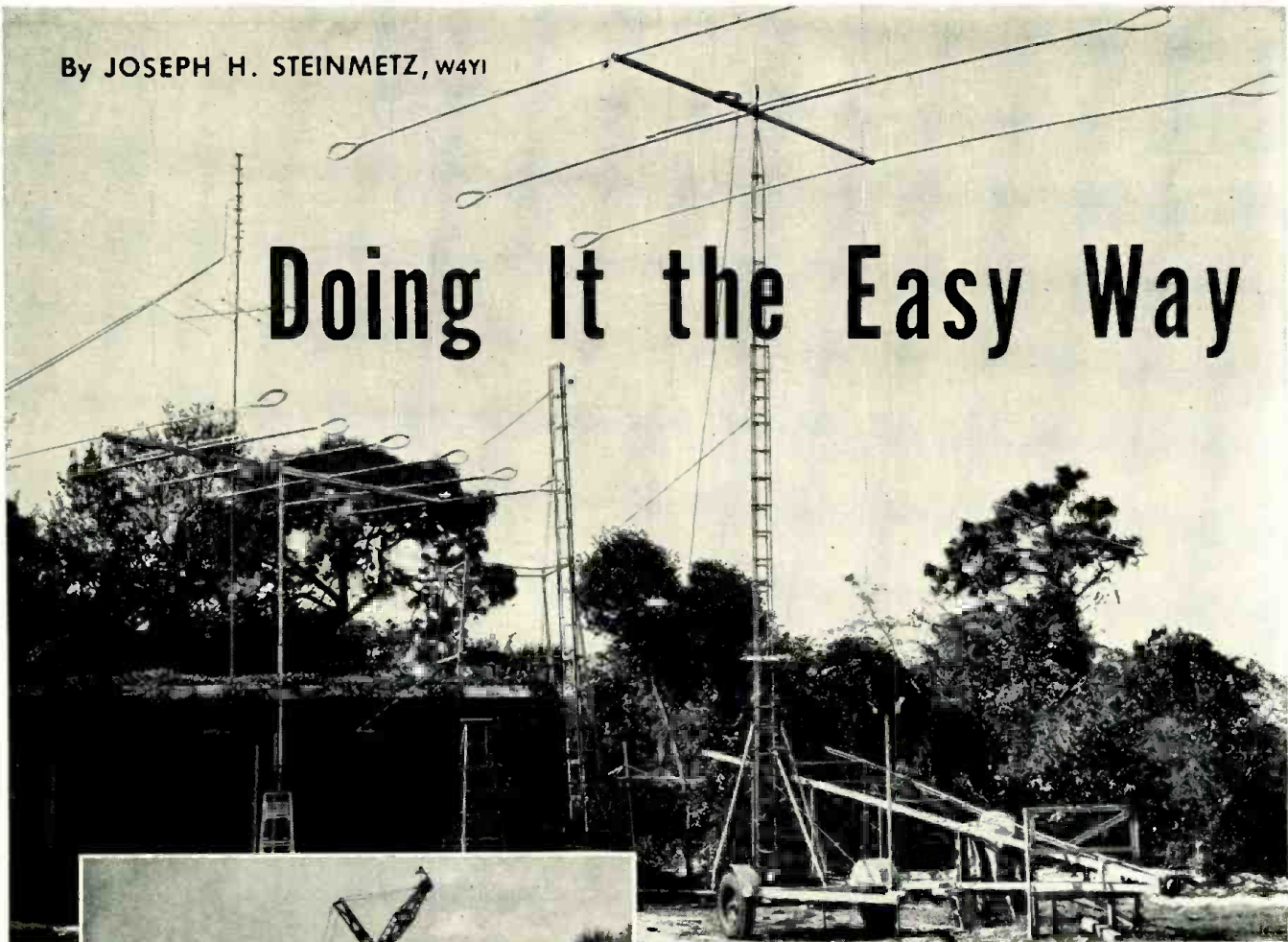

Antenna location at Steinmetz home in Sarasota. At rear and above taller ladder is base of tower, 17 ft. high, which has concrete footings 3 ft. x 3 ft. x 4½ ft. deep. The 33-ft. Vesto steel tower was assembled on ground and is seen (right) with prop pitch motor already installed. The 20-m. beam is seen against sky on temporary support, as is 10-m. beam on short pipe on garage.

Concrete Engineering Company's crane is used to lift up the 33-foot section of the Vesto tower into its vertical position while helpers insert timbers under the feet to help "true up" the entire assembly.

Concrete Engineering Company's engineer has placed the 20-m. beam on pipe and now has crane lift him, seated in a sling, and 15-m. beam, together with coaxial cable already connected so he can drop boom of beam slowly down over the pipe through 2-inch hole in boom. This proved to be a rather tricky operation but the whole business came off smoothly without a hitch.

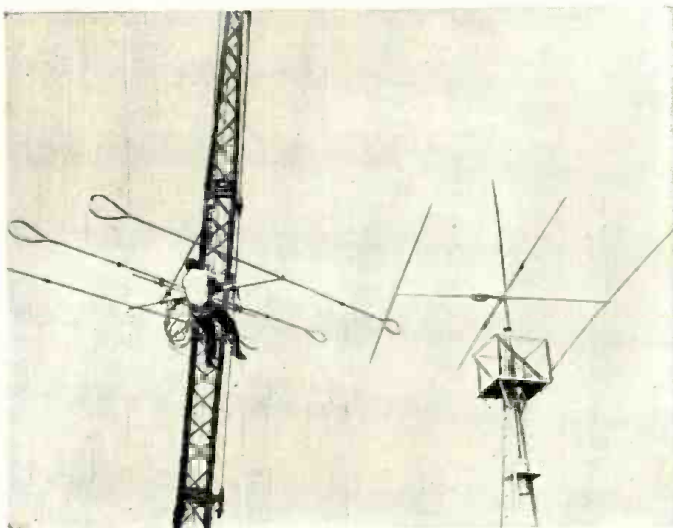

This "dream antenna" setup, belonging to W4YI and W4TFP, features a 50-foot mast and three Telrex beams; a six-element 10 meter, 3-element 15 and 20 meter arrays.

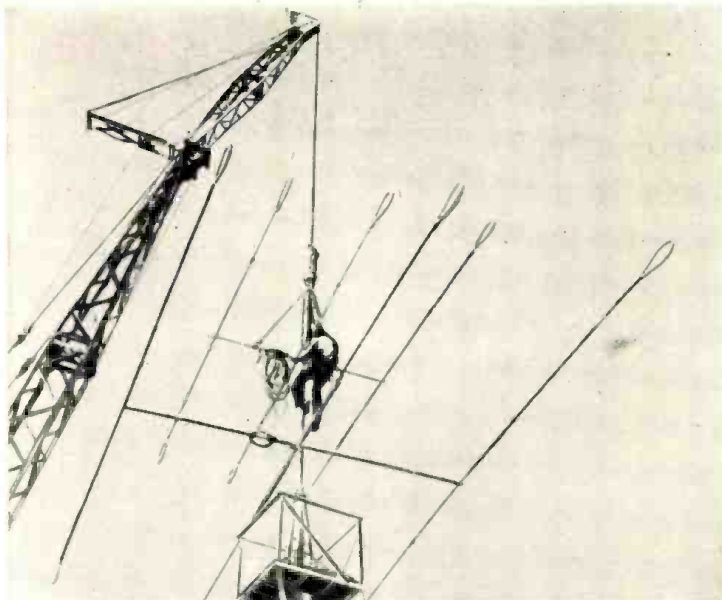

The three-element 15-meter Telrex beam is bolted into place by engineer who works comfortably and safely in the crane-lifted sling.

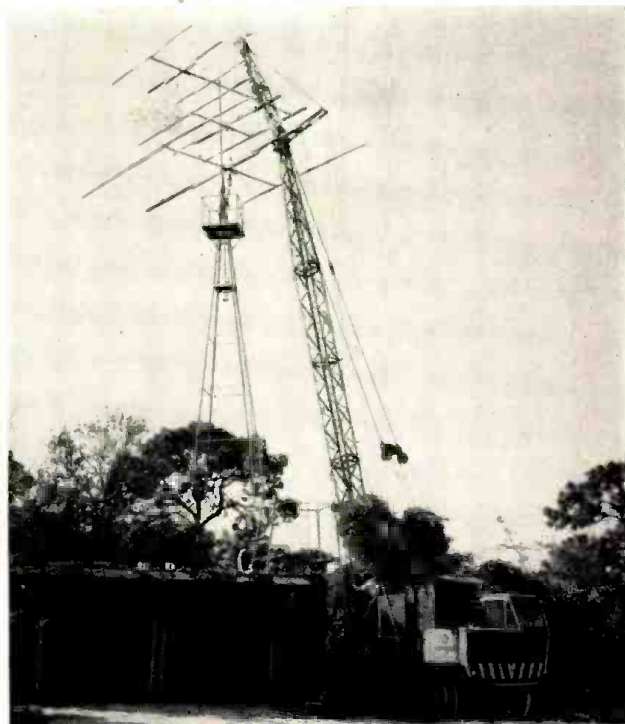

Crane swings the tower from position on the right over toward its final position. The tower is being moved across the garage in this photo of the tower operation.

**O**NCE a ham, always a ham"—and usually this includes your children as well. The antenna installation shown on these two pages and the mobile and ham shack stations shown later in the article are the proud possessions of the author and his son, Bill (W4TFP), an operator at the Duke University Electrical Engineering Department Station.

When we recently moved to our new home on Sarasota Bay, we decided that now was the time to build our "dream shack." Accordingly, we had a 50-foot tower erected which would get our three *Telrex* beams out in the clear and then fixed up an all-weather, year-around ham shack in a made-over storeroom in the back of the garage.

A specially designed desk supports the station's "Viking I" transmitter and NC-300 receiver. A five-position coaxial switch in the mahogany panelling of the shack allows instant switching from 75 to 40, 20, 15, or 10 meters. The coaxial cables are fed through the wall from the outside so that no wires clutter up the working area.

An indicating pointer, placed on Florida and moved by a selsyn behind a great circle map on the wall of the shack, shows us accurately where the beams are pointing. This selsyn is activated by a matching one geared to the rotating pipe in the tower just above the prop-pitch motor. The motor itself is enclosed in a heavy anodized aluminum tube which is bolted to the steel plate on which the motor rests. A "hat" of aluminum is fastened with its center around the mast. It overhangs the aluminum tube around the motor by 6 inches to make a water-tight seal and yet be rotatable. Heavy roofing compound seals all possible cracks.

The 75 and 40 meter antennas, the half-wave dipoles, are center-fed with 72-ohm balanced transmission twin-lead lines. When the lines get close to the ground, each feed into *B & W* balun coils and come out 72-ohm unbalanced coaxial lines, which then run into the shack and into the coaxial switch and thence to the pi network of the "Viking" final.

The shack itself is equipped with a *Philco* air conditioner for the hot summer days and an electric fan wall heater for those nippy winter mornings that we occasionally get—even in Florida!

Our mobile gear consists of an *Elmac* receiver and transmitter installed in our station wagon. For field days, Bill rigs up a *Chevrolet* generator connected to a gas-powered lawnmower to keep the battery charged during the 24-hour haul. This whole outfit is carried in a small trailer fastened to the car.

Needless to say, the author is completely "sold" on hamming as a hobby not only because it (Continued on page 120)

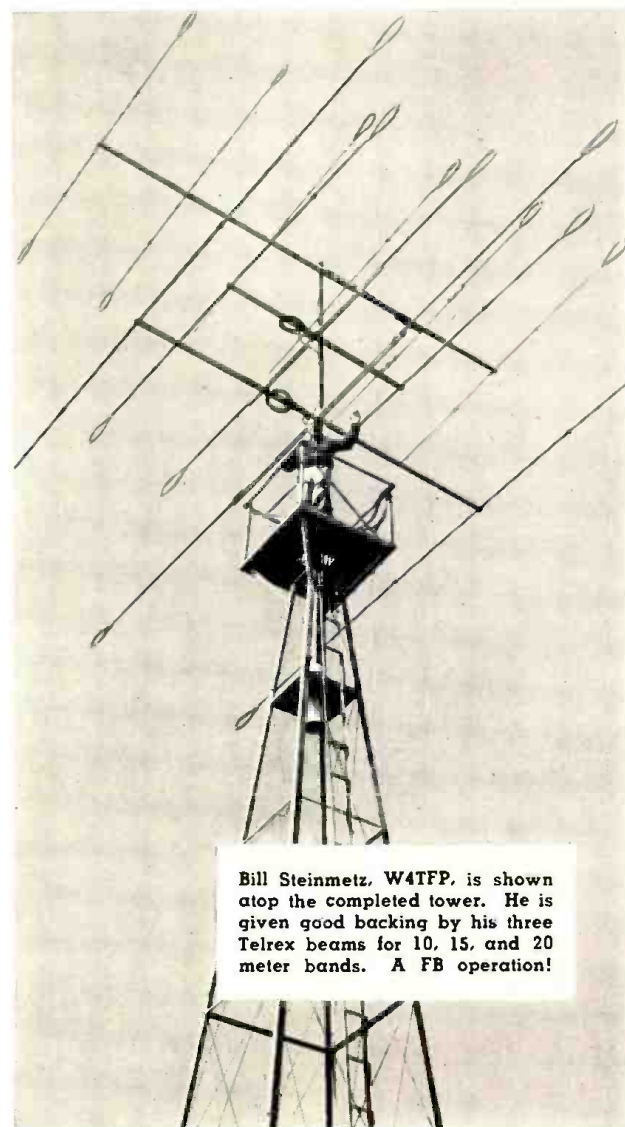

Bill Steinmetz, W4TFP, is shown atop the completed tower. He is given good backing by his three *Telrex* beams for 10, 15, and 20 meter bands. A FB operation!

# THE TUBE RACKET



Boston Police Department identification photos of Joseph Lynch, convicted of tube rebranding.

**O**N MARCH 26, 1956, in the municipal court of the City of Boston, Joseph Bernard Lynch, 35, of 82 Carver St., Boston, Mass., was found guilty on two counts: (1) with knowingly using fraudulent labels, and having in his possession counterfeiting equipment; (2) selling rebranded electronic tubes, being fully aware that the labels were fraudulent. He was sentenced to serve two years in the House of Correction.

Joseph Lynch was apprehended by the Boston Police Department working with the active cooperation of Gerald Hurley under the direction of Charles A. LaForge of the Security and Plant Protection Department of *General Electric Company*, Schenectady, N. Y. He had been counterfeiting tube labels and otherwise engaged in illegal practices of this nature for twenty years.

This conviction brings to light a practice that has been going on for a long time and has been costing tube manufacturers a great deal of money. As practiced by Lynch and others like him, the racket consists of obtaining faulty receiving tubes and returning them to the manufacturer for new tubes. The tubes thus acquired were then sold to service dealers at 70% off list price. Lynch would clean up the worn-out tubes, remove the old warranty code date and, in many cases, the tube manufacturer's label, and then place a new code date and label on the tube. This allowed the tube to be returned to the company for replacement under the warranty agreement. This practice is one of the counts under which Lynch was convicted.

*Tube rebrander jailed and extent of racket revealed in Boston police case. Manufacturers now on the alert.*

As an indication of the exactness with which tube rebranders sometimes operate, refer to Figs. 1 through 5. In Fig. 1 are shown two tubes; one is a new tube, the other is a rebranded worn tube counterfeited by Lynch. Note how similar the labeling is on the tube bases. The one on the right has the counterfeit label.

Fig. 2 shows the equipment used by Lynch to rebrand tubes. Most of this equipment was obtained through unimpeachable sources when Lynch passed himself off as a salesman for legitimate electronic companies. The various trademarks and code designations used by some of the tube manufacturing companies are shown on engraver's proofs in Fig. 3 prior to being sent out to a rubber stamp engraver. Fig. 4 shows the completed rubber stamps used by Lynch for rebranding tubes. How this is done is shown in Fig. 5. The ink is first applied to a glass plate, rolled smooth, and then the rubber stamp is applied to it. Next, the unbranded tube base is rolled along the rubber stamp to pick up the counterfeit label.

The most important aspect of the whole racket is the fact that used or defective tubes were available to Lynch for his nefarious scheme. Lynch was able to obtain quantities of defective tubes by paying his various sources as little as 2c or 3c per tube. The sources themselves bear some of the responsibility for making these tubes available to Lynch since, if they

had thought about it, they should have known that no legitimate use could be found for such tubes. Actually, some of the bad tubes that he received were within the warranty period. These did not require rebranding and obviously could be returned to the manufacturer for direct replacement. Here again, although this practice sounds legitimate, it was not. Actually, in the case of tubes that were still in warranty, these should have been destroyed since credit had already been obtained for them from the tube manufacturer. Why the manufacturer did not reclaim them himself when he extended the credit is very simple to explain.

Until the early part of 1955 most tube manufacturers would give credit or replace bad tubes that were within warranty without requiring the worn tubes to be returned to the plant. The district sales division would automatically approve such credits with the understanding that the distributor would destroy the bad tubes. Here the system fell apart as many such tubes were not destroyed but were obviously sold to individuals such as Joe Lynch.

Another method of handling in-warranty tubes, common until recently, was for the manufacturer to extend to wholesale tube buyers a discount of 5% in lieu of credit for "duds" on purchases of packaged tubes. In other words, the tube manufacturer assumed that about a 5% discount would cover the tube replacement cost and, therefore, extended the credit at





Fig. 1. One of these tubes is an old one that has been rebranded, the other is new. Note the thinner lines of the lettering of the tube on the right; it is the phony.

the time of purchase. When the defective tubes were found, it was left up to the tube wholesaler to dispose of them. This saved the wholesaler and the manufacturer the costs of handling defective tubes. Thus, many wholesalers instead of disposing of these "duds" often had them around the store in a convenient spot. This is how Lynch obtained his tubes. In this case Lynch would return them for credit to another distributor.

Tube manufacturers have been taking definite steps to run the rebranders out of business. To keep worn or defective tubes out of the hands of rebranders, *General Electric, Sylvania*, and many other tube manufacturers now use a tube-for-tube replacement plan. Under this plan, the wholesaler must send back to the tube manufacturer any defective tube covered by a warranty. The manufacturer then gives the wholesaler a new tube for it. The manufacturer then disposes of all "duds." This practice keeps such tubes out of the hands of possible counterfeiters and rebranders.

Besides this method of attack on the problem, some of the tube manufacturers are taking additional precautions. As indicated before, *G-E* is cooperating with local police authorities wherever its salesmen discover evidences of rebranding. *Sylvania Electric Co.* has offered a \$1000 reward "for information leading to the arrest and conviction of an individual or company fraudulently branding tubes with the *Sylvania* name." The *Philco Corp.* buys up all old tubes for 5c each. These and other measures are designed to cut down on this racket.

The problem goes even deeper and tube users themselves can cooperate to beat the rebrander. For example, when a TV service technician replaces a tube in a TV or radio set, the replaced tube should either be left with the customer, or else be disposed of immediately by the technician. If the tube is still covered by the manufacturer's warranty, it should be returned to the parts distributor from whom it was bought or the equipment manufacturer's distributor and sent by him

(Continued on page 120)



Fig. 2. Equipment used by the convicted rebrander and some of the tubes found in his possession when he was caught recently.



Fig. 3. These engraver's proofs contain the code numbers and trademarks of various tube manufacturers. Rubber stamps for rebranding tubes were made from these.

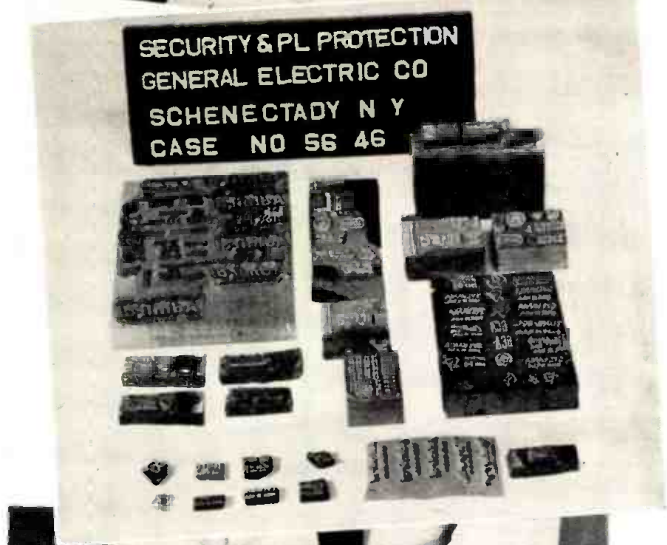
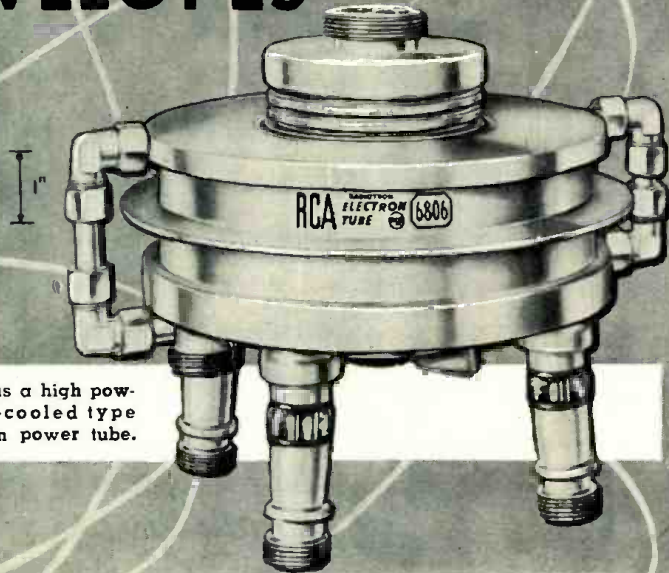

Fig. 4. Rubber stamps found in the possession of the tube rebrander. Note the wide variety of tube and equipment manufacturers represented. *G-E* was active in obtaining the evidence.



Fig. 5. How the counterfeit brand was put on a cleaned-up defective tube is shown.

# NEW DESIGNS IN TUBE ENVELOPES



RCA-6806 is a high power water-cooled type u.h.f. beam power tube.

achieved mainly because of the unusual internal construction in which the various elements are arranged horizontally and are stacked one above the other. Small ceramic spacer washers are used to provide separation between the elements. The entire assembly is then placed within a ceramic cap or envelope which is then evacuated and sealed.

The ceramic envelope is much stronger than a glass envelope and the tube can be handled, dropped, and shipped without breakage. The envelope is also extremely rugged under widely fluctuating temperatures. The stacking procedure used in assembly of the elements also provides for high resistance to vibration and shock which might otherwise cause mechanical failure. In addition, the assembly lends itself to completely automatic production methods. Although the tube was designed for high-performance military applications, it will eventually become available for civilian use.

## Type 6694-A Photoconductive Cell

The 6694-A is a very tiny, cadmium-sulfide photoconductive cell of the head-on type. It produces a signal output that is approximately proportional to the incident light intensity. Because of its very small size and high sensitivity, the cell is especially useful in those light applications where a single small photosensitive device is desired, in light-controlled relay applications, and in light meters for measuring the brightness of small luminous spots.

The 6694-A has a maximum seated length of 0.300 in., a maximum width of 0.375 in., a maximum depth of 0.220 in., and a minimum sensitive area of 0.020 in. by 0.018 in.

## G-E Ceramic Microminiature Tube

The type 6BY4 is the first of a line of microminiature ceramic tubes released by G-E for a wide variety of applications. The 6BY4 is a high gain, low noise triode which is especially suitable for r.f. amplifier service in combined u.h.f.-v.h.f. television receiver tuners.

This tiny tube envelope is made up from small ceramic and metal layers arranged alternately. In the photograph one can readily see the two button contacts at the bottom of the tube to which the heater is connected. Then above the lower ceramic ring is the metal ring that makes connection to the cathode. Above this is another ceramic ring which is followed by a grid contact ring. Finally at the top of the upper ceramic ring is the plate contact button. A special socket is required to accommodate the 6BY4. The rigid and compact ceramic construction resists shock and vibration and withstands extremes in temperature. Automatic assembly is also facilitated with this construction. Information concerning the tube characteristics and circuitry is to be found in the March, 1956 issue of RADIO & TELEVISION NEWS (see "New Tube for U.H.F. TV," page 46).

*Some new tubes recently released by manufacturers are unusual in design, construction, and appearance.*

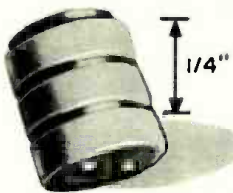

G-E ceramic microminiature tube for u.h.f.-v.h.f. television tuners.

RCA-6694-A is a small cadmium-sulfide photoconductive cell.

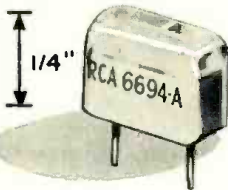

Sylvania stacked type tube with a completely ceramic cap or envelope.

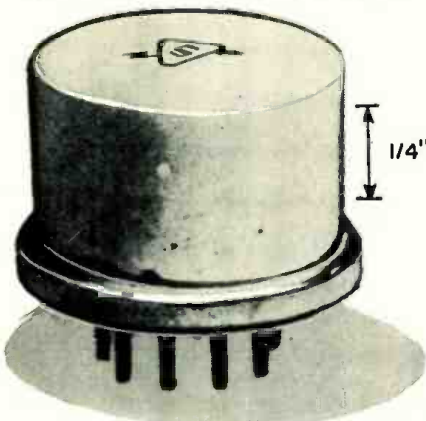

**T**O THOSE of us who have been accustomed to the ordinary run-of-the-mill variety of electron tubes, the photographs shown here may come as something of a surprise. Yet these tubes are just a few examples of some of the special types that have been released recently.

## Type 6806 U.H.F. Beam Power Tube

The 6806 is a water-cooled power amplifier intended for operation at frequencies up to 1000 mc. In television transmitter service, the 6806 can deliver 28 kw. at 550 mc. or 17 kw. at 750 mc.

The 6806 features a coaxial electrode structure in which the centrally located plate is surrounded by a symmetrical array of unit electron-optical systems. Bypassing of the screen grid is provided by built-in capacitors. Ducts for water cooling are also built in.

Other features of the 6806 include low-inductance, large-area r.f. electrode terminals insulated from each other by low-loss ceramic bushings; relatively low output capacitance; and very low feedback capacitance.

## Sylvania Stacked Tube

The stacked tube shown here employs a completely ceramic envelope mounted on a 9-pin miniature base. The shortness in envelope height is

# Transistorized Guitar Amplifier

By PAUL PENFIELD, JR.

ONE of the pleasant duties electronic equipment has to perform is that of amplifying music. Depending on the reader's viewpoint, that may be anything from classical music down to rock 'n roll. The general dissemination of music to the public had to wait for electronics. Nowadays every symphony orchestra in the country is available to anyone for the price of a record or the tuning of a radio dial. Before the electronic revolution of the twentieth century, only the privileged few could afford to attend concerts—today anyone can have music wherever he goes.

Many musical instruments depend entirely on electronics for their existence: electric organs, theremins, and electronic carillons, to mention three. Other instruments often employ electronic amplification of one sort or another, either to play to a large audience or because the natural volume output from these instruments is low. The most notable instrument which is often helped out by electronics is the guitar. Guitar amplifiers have been used for some time to allow a guitarist to play his low-power instrument before large audiences.

Because it is such a versatile instrument, the guitar is very popular. Enough citizens play the guitar so that the subject of guitar amplifiers is of wide interest. Normally, such amplifiers operate from the 117 volt a.c. line and employ vacuum tubes. This sometimes inconveniences guitarists who wish to operate from a field or outdoor arena, or who may wish to move about with their instruments, such as in a parade. Recently available high-power transistors make a high-power transistorized amplifier for guitars practical. A suitable amplifier, which the reader can easily make for himself, is described in this article. The space and weight contributed by the amplifier and batteries is small compared to normal eight-inch or ten-inch loudspeakers, so the size of the amplifier cabinet is determined entirely by the size speaker used. Since heat is no problem, the entire cabinet may be sealed or not at the builder's discretion.

The following are the general requirements that were set down for this guitar amplifier:

(1) Frequency response: not critical—50-3000 cycles-per-second is adequate, since the lowest tone played (E below C below middle C) is about 82 cycles, and the highest (2 C's above middle C) about 1000 cycles.



Fig. 1. The compact amplifier shown connected to the pickup mike on guitar. A handle or strap on cabinet would permit amplifier to be carried easily.

Construction details on a portable, easy-to-build unit which uses two power transistors and is self-contained.

(2) Distortion: not critical, since the device is only put to one use. Low-order harmonics, if kept within 5% or so, do not seem to detract materially from the sound.

(3) Noise: as low as possible—this dictated the use of a low-noise transistor in the first stage.

(4) Adequate amplification: to permit the guitarist to have as much gain as he desires, or as little. This gives the performer more versatility.

(5) Adequate power output: the unit was designed around a pair of high-power transistors.

(6) Low standby power: this dictated the use of class B operation.

(7) Lightweight, small-size: limited only by the size speaker used.

(8) Good-looking: this "extra" pleased the author's sense of beauty and accomplishment, however, the reader may or may not wish to dress up his unit. Extra work in this regard may or may not be necessary, depending on whether the reader builds his own cabinet or not.

## The Circuit

The completed guitar amplifier system, shown in Fig. 1, and again in Fig. 3 uses a pair of power transistors in the output stage. Fig. 2, the circuit diagram, shows the *Sylvania* 2N68 and 2N95 in the output circuit. These tran-

sistors are now available generally through jobbers. The other four transistors are readily obtained.

The microphone used by the author is an *Amperite* "Kontak Mike," model SKH, a high-impedance magnetic microphone specially made to pick up vibrations only from the surface with which it is in contact and not from the surrounding air. The mike puts out about the same volume level as a variable reluctance cartridge—indeed *Amperite* recommends the use of the *G-E* variable reluctance preamp, or equivalent, when connecting the mike to an ordinary amplifier.

This fact, incidentally, points up the conclusion the author reached by experiment: proper operation of the mike requires that bass boost be incorporated in the amplifier. The sound of the mike through an unequalized amplifier is quite tinny and deficient in bass. However, by properly designing a *transistor* amplifier for use with the mike, we can forget about equalization. This is simply because normal transistor amplifiers have low input impedances, which means current may flow through the mike. When it is connected to a high-impedance grid circuit, the *voltage* output waveform is amplified. With a transistor amplifier, however, the *current* output waveform is amplified. Since the mag-

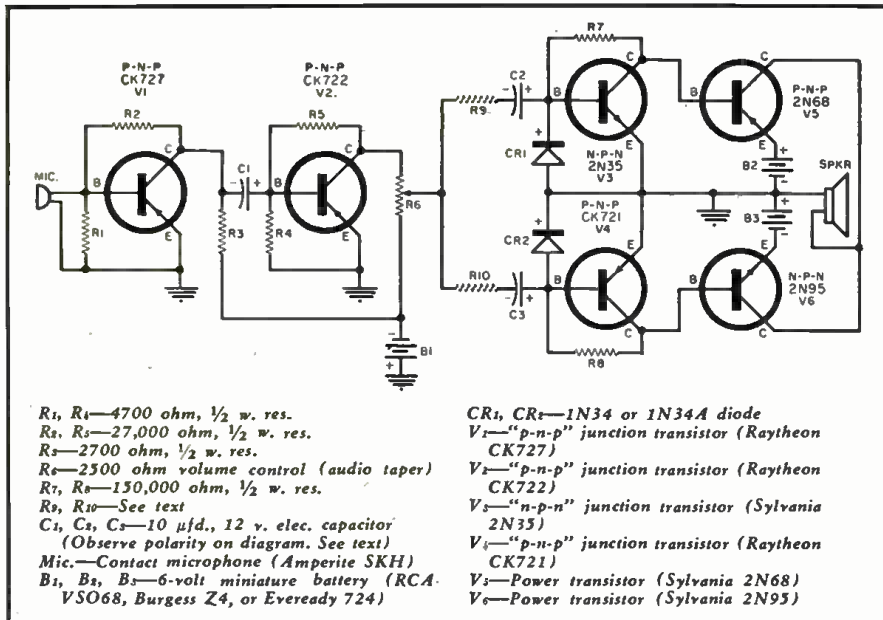

**Fig. 2. Schematic of amplifier. If more gain is required (although unlikely) V<sub>2</sub> may be changed to a CK721 or CK725 without other modifications in circuit.**

netic microphone is mainly inductive rather than resistive, and furthermore, since the load impedance into which the microphone works is so very low, approximate equalization occurs. The same thing, of course, is true with a variable reluctance cartridge—if operated into a very low impedance circuit, no equalization is required, to a first approximation.

Because no equalization is required, the amplifier is made just that much simpler. The first two stages (see Fig. 2) are standard. The 10 µfd. capacitor between them was used because it was on hand—anything upwards of 3 or 4 microfarads would do. A separate battery is used to power these first two stages to prevent motorboating, which is often a serious problem in multi-stage transistor amplifiers. The first stage uses a low-noise CK727 transistor; the second stage uses an inexpensive CK722.

The last two stages are not standard at all. The final stage, consisting of a 2N68 and a 2N95, is operated class B complementary. Complementary operation is the simplified form of push-pull possible with transistors, but not with vacuum tubes. The two transistors are of opposite types—one *p-n-p* and one *n-p-n*. One truly “pushes” while the other one “pulls” and yet the output is single-ended, and so no output transformer is required. Since there is no “opposite type” of vacuum tube, no corresponding circuit exists, and normal class B tube amplifiers have double-ended output, and must use an output transformer. In addition, the output impedance of the 2N68-2N95 stage (the two transistors are made with “equal but opposite” characteristics, and are therefore called complements of each other) is quite low, so that the eight-ohm speaker serves directly as the load. (For a discussion of this and other types of power transistor operation, refer to the author’s

article “Power Transistors,” which appeared in the February issue of RADIO & TELEVISION NEWS.)

The output stage is driven by another pair of complementary transistors operating push-pull—this time a 2N35 and a CK721. The entire collector current of each driver transistor flows through the base of the power stage transistor of the opposite type, thus there are no “coupling losses” between driver and output stages. In addition, the bias state of the last stage is determined by the bias conditions on the driver transistors which, in turn, are determined by the size of *R<sub>7</sub>* and *R<sub>8</sub>*. The almost complete absence of anything but transistors in the last two stages indicates that complementary amplifiers have a definite economic advantage over conventional transistor amplifiers!

The two diodes are arranged oppositely directed to the emitter-to-base junctions within the driver transistors, in order to prevent the base voltage of each transistor from changing when a signal is applied to the stage. If these were not in the circuit, the rectifying junction between emitter and base of each transistor and the coupling capacitor would act like a small rectifier-filter combination, building up a voltage on each base which would greatly interfere with the normal amplifier biases. This voltage would vary from time to time depending on the input amplitude, tending to keep each transistor close to cut-off.

Again, the two coupling capacitors *C<sub>2</sub>* and *C<sub>3</sub>* happen to be 10 µfd. only because the author had a few on hand. Anything upwards of 3 or 4 microfarads will do. If any value lower than this is used, low-frequency response will start to suffer.

The design of the final stage amplifier is intentionally conservative, that is, under normal operation, there is not a chance in the world that the

transistors will become overheated. The reader thus can be assured that his investment of ten dollars or more for the two final-stage transistors will not “go up in smoke” because the transistors were operated too close to their maximum ratings. Although this fact means that less power output is obtained, still the output is satisfactory for most applications and, in fact, is more limited by the speaker and its enclosure than by the final stage design.

### Construction

Since the transistors and associated components don’t require much space, the construction of the amplifier is more or less that of building a cabinet for the speaker used. Details on this of course depend on the type and size speaker used. The author’s cabinet (shown “exploded” in Fig. 3) was made out of scraps of cheap white pine and plywood to fit an existing eight-inch speaker. It was made barely large enough to enclose the speaker, as a result the acoustics of the instrument are not as good as if a larger volume of air were backing up the speaker. The reader may want to use a commercially-built speaker enclosure, in which case the remarks made here about cabinet construction won’t apply.

The author’s home-built enclosure was tailor-made for the application—a simple six-sided rectangular box, made to fit the speaker snugly. The speaker hole was not cut perfectly round, but this fact was hidden by covering the entire front panel with speaker cloth, instead of only the part behind the hole. The side panels and the rear board were finished by applying Meyercoed “plastic veneer.” The effects obtained from the “Striped Walnut” are quite striking. Of course the reader may use whatever “beauty treatment” strikes his fancy—paint, varnish, stain, or plastic veneer over unfinished wood or other types of finishes if desired.

The placement of the electronic parts is not at all critical. It is recommended that the jack for the mike be mounted close to the bottom of the case, to prevent a sudden tug on the cord from upsetting the amplifier. The volume control and the “on-off” switch may be mounted anywhere that is convenient.

The author mounted his batteries by chiseling out a depression of the right size in one of the side panels, and then forcing the batteries into it, and holding them in with a rubber band held down by thumbtacks. The reader may prefer to use a metal clip of some sort to hold down the batteries; however, the rubber band is simple and (unless it breaks under the tension) makes a very effective holder.

The power transistors are bolted directly to the speaker frame. This is possible because the two collectors of the final stage are connected together. (The case of each transistor is connected internally to the collector to

provide proper heat sink operation.) The speaker frame thus acts as the required heat sink. The leads were cut to a quarter of an inch and a standard subminiature tube socket was used. Since the transistor is immobile, of course, the socket must be soldered to three flexible leads.

The rest of the transistors were also mounted by plugging them into standard subminiature tube sockets. For the three *Raytheon* transistors, pins 1, 3, and 5 were used and for the *Sylvania* 2N35 transistor, as for the two power transistors, pins 1, 4, and 5 were used. The subminiature tube sockets were then mounted by bending the two unused terminals to one side, and soldering them into one lug on a soldering strip. The reader may, of course, use whatever system he desires for mounting the sockets, or if he wants may solder the transistors directly in place in the circuit.

The input stage should be mounted relatively close to the input jack, although the absence of power-line a.c. eliminates the hum problem completely. Still there is the possibility of undesirable feedback occurring from output to input if the input leads "wander about" too much.

Other than these few tips, the construction of this amplifier should not prove very difficult for anyone with transistor wiring experience. Not more than one or two evenings should have to be spent on the electronic construction, and probably not much (depending on the reader's carpentry skill) on the cabinet. The device is thus a "one-week project" for anyone wanting a good portable guitar amplifier.

### Performance

The instruction sheet sent out with the *Amperite* microphone suggests a number of possible ways to attach the mike to guitars, violins, harmonicas, pianos, accordians, etc. Two ways were tried by the author. In the first, the mike was forced under the strings just below the bridge (this is not possible on all guitars), and in the second the mike was held with paper clips to the sounding board. If neither of these ways works on the reader's guitar, he may be able to use *Scotch* tape, rubber bands, etc., to advantage. A little experimentation is necessary to determine the proper placement.

After the instrument is made and the mike fastened to the guitar, the device may sound distorted. In fact, the chances are that the amplifier will sound distorted, and for a very good reason. Present quality control on transistors is such that it is impossible to obtain two matched units simply by buying two transistors. This is especially true of power transistors. The 2N68 and the 2N95 the reader buys may have quite different gains, unless the reader is willing to write the manufacturer direct and pay extra for matched pairs. Since the gain of the two sides will, in general, be quite different, considerable second-order distortion is generated. If the reader has

access to an oscilloscope and signal generator, a sine wave may be injected into the amplifier and the output waveform viewed. In general, there will be a fair amount of distortion. Fortunately, however, it is rather easy to get rid of the trouble. Resistors  $R_6$  and  $R_{10}$  are inserted for just this purpose.

The effect of these resistors (generally one of them will be zero, and the other one anywhere up to a couple of thousand ohms) is to cut down the signal feeding the side with the higher gain, thus equalizing the output from both sides. Finding the proper value for this resistor is not difficult: if an oscilloscope and signal generator are at hand, merely find the size resistor in either of the two leads which gives the best-looking output waveform. If no scope is handy, a rough job may be done by ear—merely find the value which gives the most pleasant output sound. The reason the adjustment is not critical is that guitar sound waves generally have a high content of second and third harmonics in them anyway, and so the addition of a few percent more second order distortion is insignificant. Care should be taken in construction to make sure that this adjustment can be made easily after the unit is built. For this reason, the leads to the bases of the driver transistors,  $V_3$  and  $V_4$ , should not be buried where they are hard to get at.

Once this adjustment is made, the quality of the sound coming from the amplifier will probably be limited only by the speaker and enclosure. For a really portable system, the case will be quite small, with a resulting loss of fidelity. A compromise between small size and good quality must be made by the builder. The author's eight-inch speaker and small cabinet may seem too large for some readers or it may seem too small for others.

In practice, the noise level is audible if the volume is turned up all the way. However, when this is done, the device has phenomenal sensitivity, picking up and amplifying even the tiniest scratch

on the guitar case. At normal playing volumes, noise is no problem.

Guitarists not used to playing with a mike will be surprised at the inadvertent scratching, rubbing, etc., which they normally do in the course of playing, and which will be audible through the amplifier. This, of course, is one of the drawbacks of this type of electric guitar, which amplifies vibrations of the sounding board. A little practice is necessary to get the best music out of the system as a whole.

All through the article, the author has tried to suggest variations which can be made on the amplifier, to improve it from the user's viewpoint. A few other improvements suggest themselves: for example, a handle or carrying strap would be desirable. An arrangement for carrying the amplifier on the person may be useful in parades, or other walking activities. The amplifier could be built in a cardboard box to reduce weight or, alternatively, a metal cabinet could be used to make the unit more rugged.

The reader may be interested in using the amplifier for other purposes than just guitar amplification. Other musical instruments, of course, can be amplified with this device, for example, xylophones, ukeleles, cellos, certain drums, mandolins, pianos, banjos, etc. Or else, the device could be used with the contact microphone as a vibration tester—completely portable and ready for use "in the field."

If desired, an output jack may be added to allow the amplifier to feed a public address system, or to allow the output to be viewed on a scope, or fed into a tape recorder. The possibilities of adapting this amplifier to special purposes is, of course, practically unlimited.

But for a simple, all-around portable guitar amplifier, this will do the trick. It is lightweight (limited mainly by the cabinet), small, easy to construct, easy to operate, and adequate-sounding. This is about all that can be asked of a transistorized guitar amplifier.

-30-

Fig. 3. Interior view of the amplifier with the sides "exploded." Note the two power transistors (one almost hidden) bolted to the loudspeaker frame.

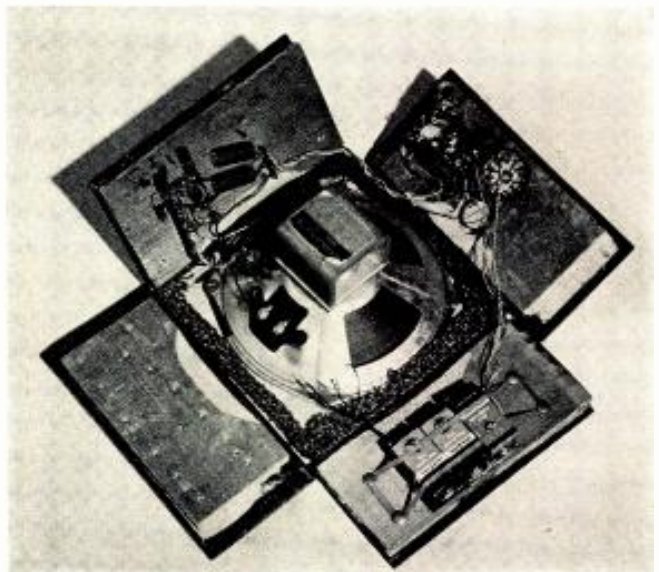

# Bass Reflex

## Design or Accident

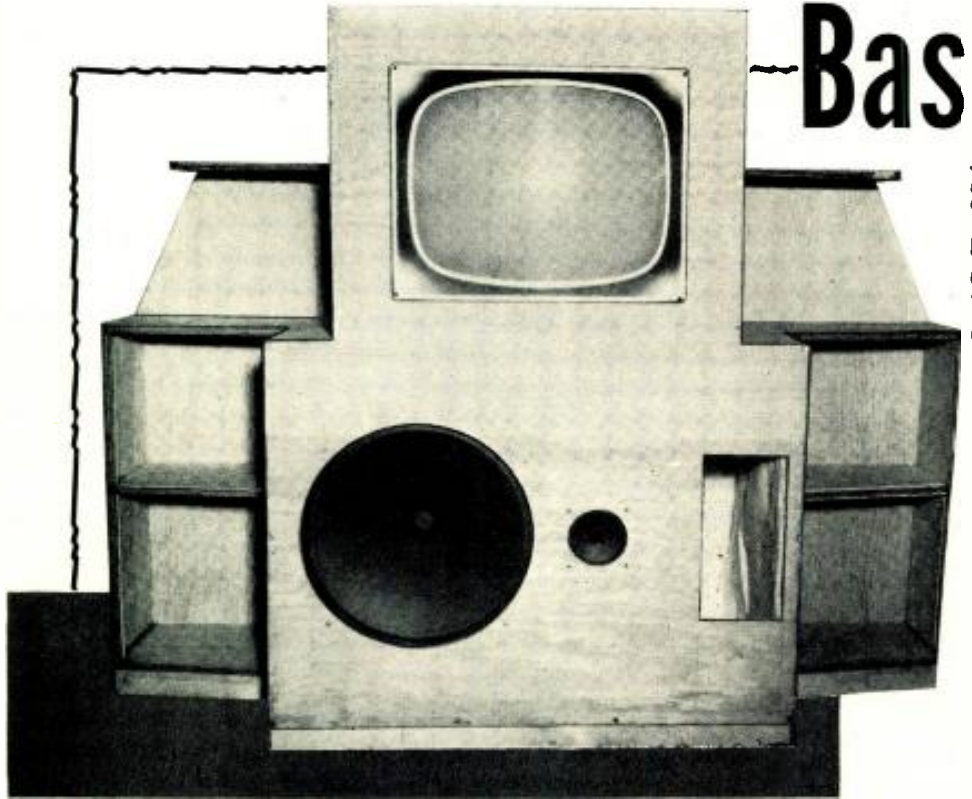

Over-all view of the author's home "entertainment center" which includes a TV set and bookshelves in addition to the amplifier and speaker enclosure. A grille cloth covers front of enclosure and entire unit was painted to match living room decor.

By  
**ROBERT C. SANFORD**  
Asst. Editor, Bell Laboratories Record

*Practical design data on such enclosures is rare—the author offers workable information for various sizes of speakers.*

**W**HETHER you are a hi-fi addict or just happen to like good clean bass reproduction, the least expensive and certainly the simplest type of speaker enclosure for home construction is a bass-reflex or "phase-inverter" type; all it amounts to is a box with a hole in it. Having a fairly good 15-inch speaker on hand, and being in the process of rebuilding a radio-TV-phono combination and putting it into a new cabinet, the author decided to build a bass-reflex.

With access to one of the best technical libraries, it was just a matter of looking up the details as to the size, shape, and location of the port, and the size and shape of the enclosure. This beautiful day-dream was quickly shattered because, instead, some authorities treat a bass-reflex as a Helmholtz resonator, some as a special type of resonator, and others, not wishing to commit themselves, simply ignore it!

Reputable authorities in the acoustic field as well as several writers of magazine articles disagree widely on the principles involved, the descriptive equations, the equivalent diagrams, and even the symbols. Nowhere could the author find a simple down-to-earth explanation with a workable equation. Some of the equations advanced by various writers are not even dimen-

sionally correct; others, while dimensionally correct, have no logical basis. Most important, they don't work. After pages of "design" information, each explanation ends up with, "for best performance, tune the port." Why bother? You might as well build a box, cut a hole in it, measure the response, and try again until it's right.

This is no way to build a speaker enclosure. So, with absolutely no qualms, the author worked out his own explanation, equivalent diagram, and equation using his own symbols. Undoubtedly they will not agree with those of certain authorities but they are bound to agree with some of the others! The important thing is, the equation works. For those who just want the facts, Table 1 gives all the information; for those who want more—read on.

A loudspeaker, with or without a

**Fig. 1. Measuring loudspeaker resonance.**

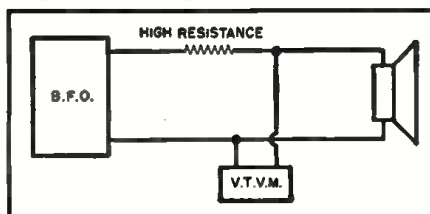

baffle, is a mechanism that converts electrical energy into mechanical motion, which in turn is converted into acoustic energy. A speaker has quite a low impedance; coupled to an output amplifier tube through a matching transformer, it sees the high plate impedance of the tube. Thus, a speaker is fed from a high-impedance source and is essentially a constant-current device. To measure the impedance, feed the speaker from an audio signal generator through a high series resistance, Fig. 1. With a constant current through it, the voltage measured across the speaker will go up or down with the impedance. Fig. 2 was plotted for the author's speaker, using a v.t.v.m. and a b.f.o. output of 10 volts through 200 ohms.

The electrical resistance, inductance, and capacitance are of little importance at low frequencies; the mass of the cone, voice coil, and their supports and the compliance of the supports determine the resonant frequency. One other quantity is viscous friction set up by the cone moving through the air. It is low at low frequencies, increasing with frequency until the diaphragm circumference approximates the wavelength, and then stays nearly constant.

The current is the same throughout a series electric circuit and inductance is the controlling factor because it tends to keep the current constant. Current through a capacitance can be changed at will, so capacitance offers

a "compliance" to current. In a series mechanical circuit, mass offers resistance to change in position or motion while a restoring element or spring supplies compliance. Mass, then, is analogous to inductance and compliance is analogous to capacitance. Viscous friction is the mechanical analogue of resistance.

Fig. 3 shows how these quantities are coupled to the electric circuit. The voice coil is part of the electric circuit and is *mechanically* coupled to the cone and its supports. There is no *electromagnetic coupling* as is shown in some equivalent diagrams. At mechanical resonance, the cone excursions become quite large, indicating minimum mechanical impedance, yet at the same time the measured electrical impedance becomes a maximum. Why the discrepancy? The answer is the voice coil moving in a magnetic field. As it moves, it induces a counter-e.m.f. in itself, reducing the effective applied voltage. This is equivalent to raising the voice-coil impedance. Minimum mechanical impedance produces maximum voice-coil motion and therefore maximum electrical impedance. When mechanical impedances are translated into their electrical equivalent, they are inverted and result in a parallel electrical circuit, Fig. 4. The effect of mass is now analogous to that of capacitance while compliance acts as inductance.

Another way of looking at it is: with a constant current, a higher impedance produces a higher voltage and therefore more power is used. More electric power means more movement of the cone. In either case, higher impedance goes with more cone movement so the impedance is a measure of the sound pressure output. Whether or not a given sound pressure at a given frequency is audible is determined by your ear. For example, the sound pressures at 30 and 120 cycles represented by Fig. 2 are about the same, yet the 30-cycle note sounds much weaker. The idea of a bass-reflex is to damp the speaker resonant peak and boost the frequencies below the peak.

If the speaker is placed in a completely enclosed box, the air inside the box will act as a spring, tending to reduce the cone movement. This is shown in Fig. 3 as an additional series compliance. Translated into the electrical circuit of Fig. 4, it acts as another inductance in parallel, raising the amplitude and frequency of resonance. See Fig. 5.

If we now cut a hole or port in the box, the springiness of the enclosed air will be reduced. The mass of air in the port acts as a virtual diaphragm; this, together with the compliance of the enclosure, forms a second tuned circuit. The enclosure compliance is common to both the speaker and port tuned circuits. This time, however, the compliance instead of the mass is the driving element. There is a time lag between motion of the air near the speaker and of the air mass in the port because of the compliance, or

"squeezeability," of the enclosed air. At the port resonant frequency the time lag is that of a half wave and the virtual diaphragm moves in the same direction as the speaker cone. This "phase inversion" results in sound from the port being in-phase with that from the speaker while at the same time the speaker is heavily damped to reduce its output.

The effect of the port is equivalent to adding mass and viscous friction in parallel with  $C$  in Fig. 3 or inductance and resistance in series with  $1/C$  in Fig. 4. At the frequency where the port and compliance resonate, the impedance across the circuit in Fig. 4 will be very low. If this is the frequency at which the speaker resonates, the low impedance of the series resonant circuit will shunt that of the speaker, holding down its normal impedance rise.

The resulting curve, Fig. 5, shows two smaller peaks, one above and one below the speaker resonant frequency. The frequency of the dip between the two peaks is that of the enclosure and port; for a given volume and port area, this frequency will be the same *irrespective of the speaker used*. The speaker does, however, affect the amplitude and frequency of the two peaks. Above resonance the speaker-tuned circuit is capacitive, Fig. 4, while the port-tuned circuit is inductive. As the frequency is lowered, the reactances approach each other in value and eventually become equal; this produces the upper peak. Below this, the shunting effect of the port-tuned circuit predominates and causes the dip. At still lower frequencies, the reactances of the two tuned circuits are reversed, producing the lower peak. It is this lower peak that extends the low-frequency range. The small peak at the bottom of the dip is the result of placing the speaker and port as far apart as possible. It is a form of overcoupling of the tuned circuits.

Apparently, a complete mathematical description of the impedance of a speaker system involves Bessel functions of the first and second kind. However, over the frequency range to

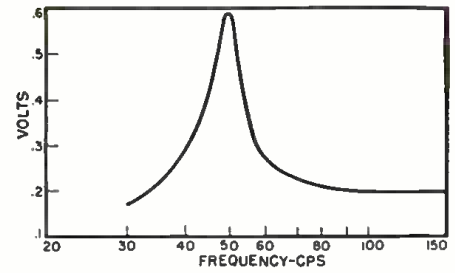

Fig. 2. Voltage measured across voice coil when the speaker is fed as shown in Fig. 1.

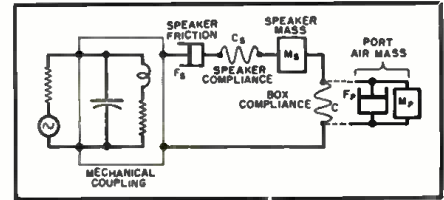

Fig. 3. Coupling of the mechanical elements.

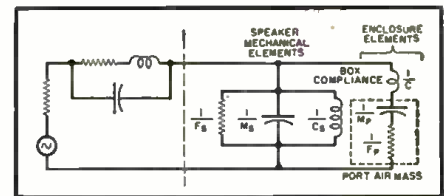

Fig. 4. The equivalent electrical circuit.

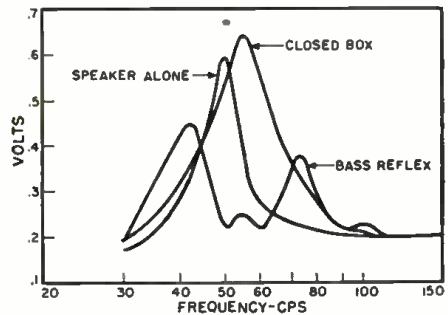

Fig. 5. Composite curves of the system.

be considered, the impedance approximates that of a simple resonant circuit. No matter how it is produced, resonance always occurs when two elements provide equal amounts of opposing types of reactances. For a

Table 1. Basic formulas for determining cabinet dimensions and sizes of port areas.

$$F_s = A \rho c \text{ above } 2\pi R/\lambda \approx 1$$

$$X_{ms} = A d \rho c \omega$$

$$X_{cs} = A^2 \rho c^2 / V \omega$$

All values in mechanical ohms where  $A$  is the port area and  $R$  is the equivalent radius  $\sqrt{A/\pi}$ , both in square meters.  $\rho$  is the air density in kilograms-per-cubic meter;  $c$  is the velocity of sound in meters-per-second;  $V$  is the enclosure volume in cubic meters;  $\omega$  is  $2\pi f$ ; and  $d$  is the thickness of the enclosure wall at the port in meters.

$$f = \frac{c}{2\pi} \sqrt{\frac{A}{dV}} = 54.7 \sqrt{\frac{A}{V(d + 1.13\sqrt{A})}}$$

$$V = \frac{2992A}{f^2(d + 1.13\sqrt{A})}$$

and:

$$A = \frac{.64V^2f^4}{k^4} + \frac{f^2Vd}{k^2} = \frac{f^3V}{2k^4} \sqrt{1.63V^2f^2 + 5.12k^2Vd}$$

where:  $f$  is in cycles-per-second;  $k = 54.7$ , and all dimensions are in meters

speaker system, the reactances can be expressed in three different units: electrical ohms, mechanical ohms, or acoustic ohms. The author chose to work with mechanical ohms because dimensionally they are easiest to handle.

Using dimensional analysis and common sense, the author came up with values for the viscous friction, mass reactance, and springiness (reciprocal of compliance) reactance in mechanical ohms that agreed with most of the texts. Setting the reactances equal, the equation for resonance was derived:

$$f = (c/2\pi) \sqrt{A/dV}$$

or, in a more familiar form:

$$f = 1/(2\pi \sqrt{Ac^2/dV})$$

where  $A$  is the port area,  $V$  is the enclosure volume,  $d$  is the thickness of the enclosure wall at the port, and  $c$  is the velocity of sound.

But, this is the equation most authorities give for a Helmholtz resonator! Such a resonator is usually spherical so that no two surfaces are parallel, the inside surfaces are smooth, and the largest dimension of the port is considerably less than the smallest dimension of the enclosure. The dimension  $d$  usually refers to the length of a small tube extending from the resonator and forming the port. All these criteria are disregarded in a conventional bass-reflex, so it cannot be a typical Helmholtz resonator. Besides, the equation doesn't work for practical enclosures.

What to do? Further reading brought to light the fact that a resonant column such as an open-ended organ pipe is slightly shorter than the sound wave produced. The length must be modified by an "end correction." If the pipe is open on both ends, the end correction must be doubled. The value of the end correction varies according to how the pipe is terminated, but for a pipe ending in an infinite baffle (flanged pipe) it is considered by most authorities to be 0.85 times the radius; for both ends, this becomes 1.7 times the radius. Since the wall thickness of a bass-reflex enclosure corresponds to the length of the exit tube of a Helmholtz resonator, it was as-

sumed that a "finagle factor" was needed.

The thickness now becomes  $d' = d + 1.7R$  where  $R$  is the equivalent radius of the port area, or  $\sqrt{A/\pi}$ . Unfortunately, the calculated frequency does not agree with that measured for an actual enclosure. Some port areas were tried as were the values of areas and resulting frequencies from published articles. Something was still wrong with the equation.

Considerable thought went into the problem and it was finally decided that the end correction was too small. The value for a pipe presupposes that the radius will be small in comparison with the length. If the pipe is shortened almost to nothing, certainly to less than the radius, the end correction becomes the major factor. What would be the limiting value? Assuming the thickness to be negligible, it seemed logical that the maximum value of the end correction should be 1.0, or equal to the radius. Since both sides of the port have to be considered, the "finagle factor" should be 2.0. The enclosure that resulted is shown in the photograph, page 46. The port area is 50 square inches; checking back from the measured curve, this gives a "finagle factor" of 1.96, approximating the value of 2.0, well within the accuracy of the measuring equipment. The final equation is:

$$f = 54.7 \sqrt{A/V(d + 1.13\sqrt{A})}$$

with all dimensions in meters.

Since the cabinet had already been constructed, finding the proper port area was next. As can be seen from the equation, the lower the frequency of resonance, the larger the volume or the smaller the port. The port size affects the "Q" of the port-tuned circuit but not in any easily determined way. The "Q," in turn, affects the amplitude at the dip and the amplitude and frequency of the peaks. A generally accepted rule is that the port area should be nearly the same as that of the speaker. This is OK for small speakers but the enclosure gets unwieldy for large speakers because as the port area goes up, the enclosure volume must also go up to maintain the same resonant frequency. A good rule to follow is to make the port area

$A$ , in square inches, equal to the speaker resonant frequency when the speaker area, in square inches, is greater than the resonant frequency.

Ordinarily, the best procedure is to buy the speaker you want, decide on the value of  $A$ , and then find the volume required. Once the volume is known, you can decide on the shape of the enclosure to fit your needs. In finding  $A$ , use the *active* speaker area. This is the area out to, but not including, the first corrugation at the cone edge. The author's 15-inch speaker has an active diameter of only 12.5 inches. Once the port area is determined, the required volume can be found by:

$$V = 2992A/f^2(d + 1.13\sqrt{A})$$

again with all dimensions in meters.

Just a note at this point. The volumes of the enclosures discussed have been calculated from chosen values of port areas. In order that the port areas would be the same as speaker areas, typical values of active cone diameters were selected for several sizes of speakers and the active cone areas calculated.

Since speakers vary widely in construction, the active diameters and hence the calculations are only approximate. Moreover, all the data in Table 2 was calculated using a value of zero for the diameter, the thickness of the cabinet wall. From the equation for volume it is obvious that the thicker the cabinet wall, the smaller will be the volume required.

While the data given in the table is a close approximation of the correct volumes, it is not a substitute for individual calculations. Each particular speaker and enclosure must be calculated individually.

Because the author's enclosure is part of a TV set and bookcase combination, 1/2-inch plywood was used to keep the weight down. Three-quarter-inch or one-inch plywood is preferable. The builder's enclosure should be rectangular with at least one long front dimension. Don't make the depth too shallow, but try to avoid having any two dimensions the same. The author's is 20 x 22 x 30 inches inside. Use *both* glue and screws to put it together. Internal braces should be placed diagonally across each surface to reduce vibration.

The speaker and port should be at the ends of the long side, and it doesn't matter whether the enclosure is upright or on its side. If it is upright, move the port up from the floor a few inches. Don't use a shelf inside because this divides the volume into two acoustically-coupled resonators and will necessitate a return to cut-and-try methods to determine the shelf and port size. To avoid unwanted box resonance from the parallel surfaces, line the inside with some soft sound-absorbing material. The author used cotton because it is cheap and light, but better materials are available. Finally, don't forget to subtract the volume occupied by the speaker, braces, and soundproofing.

Table 2. Approximate dimensions calculated for a few of the more popular speaker sizes. As mentioned in text, no allowance was made for thickness of cabinet wall.

FREQ. (cps)	SPEAKER		A (square inches)			
	6-INCH	8-INCH	10-INCH	12-INCH	15-INCH	
50	4.201	5.365	6.800	8.380	10.520	
60	2.911	3.805	4.720	5.815	7.160	
70	2.140	2.796	3.468	4.272	5.360	
80	1.640	2.140	2.660	3.270	4.110	
90	1.290	1.690	2.097	2.585	3.245	
100	1.050	1.370	1.702	2.095	2.630	



# Sun-Powered Radio



The Admiral radio with the "Sun Power Pak" is shown here. 32 silicon cells comprise the power pack which is shown in the small zippered case on the right.

*The world's first commercial sun-powered radio is also completely transistorized and will work off 6 drycells.*

**M**ARKING the culmination of over 18 months of research and development work, the *Admiral Corporation* recently introduced the world's first sun-powered tubeless radio designed for the consumer market. The silicon solar battery used to power the new radio is the first such device designed to convert useful amounts of the sun's energy directly and effectively into electricity for radio. The transistor radio itself without the sun power pack retails for \$59.95. The sun power pack is priced at \$175.00.

The *Admiral* set contains six transistors in place of vacuum tubes. The "Sun Power Pak," as an optional accessory, plugs into the back of the unbreakable cabinet, cuts out the conventional batteries, and converts the sun's rays instantaneously into electrical energy. The unit is so sensitive that it can also operate satisfactorily on overcast days.

The solar battery consists of 32 individual quarter sections of silicon solar cells, each of which can convert sunlight into electrical power with a much higher efficiency than has been achieved with any previous photovoltaic device. The silicon battery converts more than 15 per-cent of the energy it receives from the sun directly into electrical power. The solar cells are made from pure silicon which has first been treated with a small amount of an impurity so that it becomes "n", or negative, conductive material. It is then subjected to a gaseous atmosphere so that a controlled

amount of "p", or positive conductive impurity, will diffuse into a very shallow layer (1/10,000th inch in depth) on the surface of the crystal. This process results in a "p-n" junction which is very sensitive to light. Photons of light energy, striking the surface of the silicon crystal, split off an electron from its normal position in the crystal lattice, leaving a positively charged "hole" or vacuum space. Both the electron and the "hole" will then be available for the conduction of electricity.

The solar cells in the power pack are encased in a block of clear plastic with a silicon oil center. The block measures approximately 6 inches long, 4 inches wide, and ½ inch thick. The plastic covering and oil center allow the best focusing of solar energy on the surface of the silicon cells.

The 32 cells are series connected to deliver a total of 9 volts at 15 milliamperes. Each quarter cell is capable of delivering 4.5 milliwatts of power. The solar cells are most efficient when exposed to light of the upper spectral region ranging from red to infrared. For demonstration purposes, the "Sun Power Pak" can be activated equally well by an artificial source of light such as an electric bulb or an infrared lamp. The unit can operate over a wide range of temperatures from 185 degrees Fahrenheit to minus 60 degrees Fahrenheit. It is protected from shock damage by the silicon oil center and strong plastic outer shell.

Although silicon is one of the most abundant elements on earth, being



found everywhere in sand, pure silicon is very scarce and presently costs over \$300 a pound. The solution to the present high price depends on the ability of metallurgists to find a better and less costly refining method. Solar batteries are expected to cost considerably less after producers effect manufacturing efficiencies and get into mass production.

The transistor radio itself contains six transistors, plus one detector and one a.g.c. crystal diode. It has a maximum power output of 250 milliwatts, with a sensitivity of 175 microvolts.

Without the "Sun Power Pak," the *Admiral* tubeless radio can be operated by six ordinary flashlight batteries costing less than one dollar. Since the set requires less than 1/10th the power consumed by a conventional portable radio, the flashlight batteries will last from 700 to 1000 hours before requiring replacement.

Printed wiring is used throughout the chassis of this set. Another feature is the rotatable antenna which pops up under the handle at the touch of a button and may be oriented for best reception. This allows the radio itself with its speaker to be in a fixed position, facing the listener. —50—

# New Techniques for

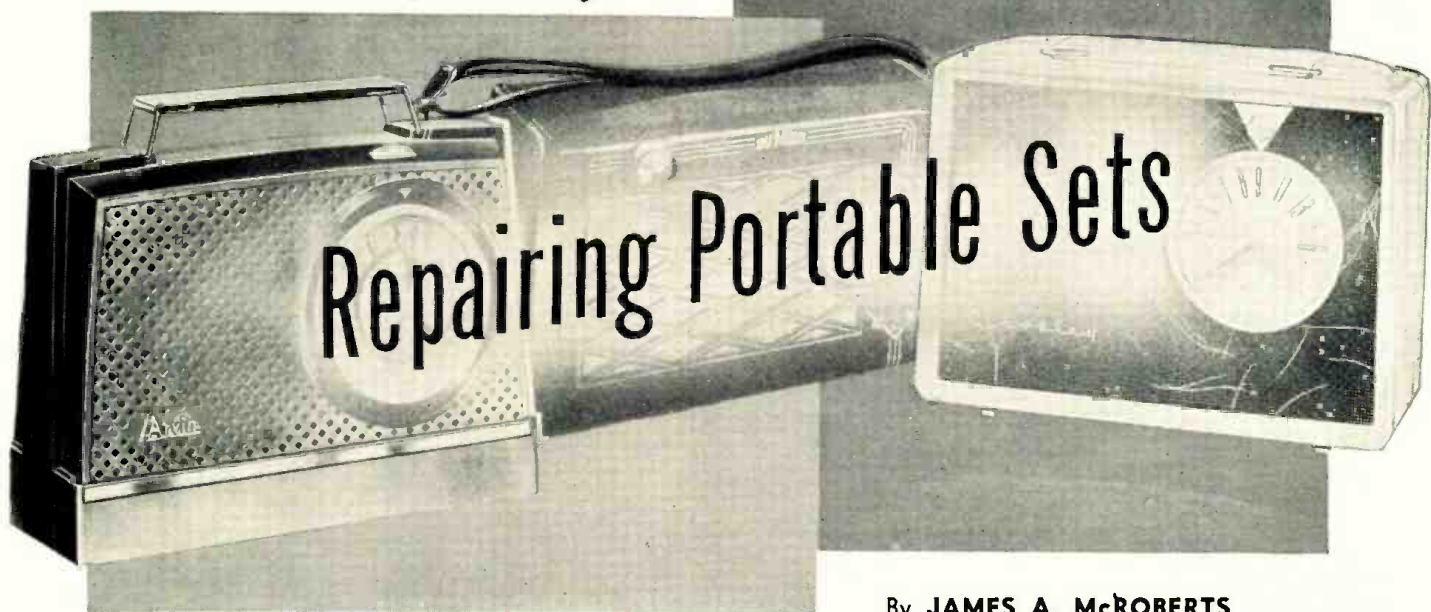

## Repairing Portable Sets

By JAMES A. McROBERTS

*This is the portable radio season and you can keep them operating if you keep up-to-date on the latest techniques.*

**M**ODERN three-way portable radios require some special servicing techniques because of their compact design and some of the recent developments they incorporate. High "Q" antennas have replaced the more cumbersome loops of the earlier models, and dry rectifiers have almost completely superseded tubes. Transistorized models are appearing in increasing numbers and some of their troubles are the same as those encountered in the tube types treated here.

### Oscillator Failure

Portables, either straight battery or three-way, suffer oscillator failure frequently. The most usual symptom is a set that sounds alive but offers no reception. Touching the stator of the tuning capacitor r.f. or oscillator section produces a click in the speaker and noise comes through, but alas, no signals from stations. Several faults in the oscillator circuit will cause this condition, refer to Fig. 1.

Such sets almost invariably employ a type 1R5, or equivalent, as a converter. This tube is extremely critical as to its screen voltage and will tolerate only about a 15% drop. In the circuit illustrated, the tolerance is about 5 to 6 volts below the nominal 38 volts with fresh batteries, or normal power line operation. All voltages in this circuit should be checked with a high-resistance voltmeter.

The type 1R5 is equally critical with respect to its filament voltage, or even more so. Normally, it is run at 1.5 volts or a trifle under for long tube

life, not less than 1.25 volts, however, for stable oscillator operation. The tube will perform as a mixer and the i.f. tubes will function in such sets with a filament voltage as low as 1 volt. But for the oscillator, instability and erratic operation sets in when the filament receives about 1.15 to 1.2 volts, depending on the applied screen and plate voltages.

Measurement of the filament, screen, and plate voltages is the first step whenever oscillator failure occurs. To correct for insufficient supply voltages, check the power supply. Pay particular attention to the screen dropping resistor ( $R_s$  in Fig. 1), and screen bypass capacitor ( $C_s$ ). Test the latter by shunting with a capacitor known to be good. (The test capacitor may be as high as .05  $\mu$ fd.)

Fig. 1. Partial schematic diagram of a Motorola HS-454 3-way portable showing the converter stage. Note the "gimmick."

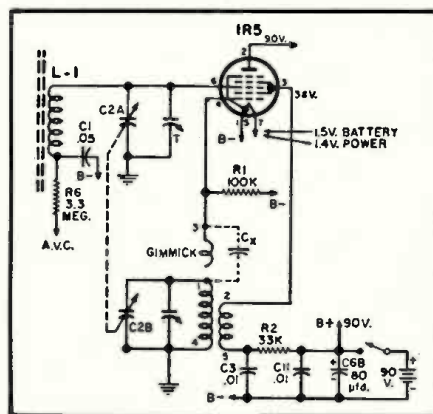

In addition to the screen bypass capacitor, test the power supply filter capacitors ( $C_{6B}$  and  $C_{11}$  in Fig. 1).

Another frequent source of oscillator failure in many of the modern oscillator circuits is the "gimmick" coupling capacitor. The trouble is always too little capacity between the "gimmick" and the oscillator coil (across terminals 1 and 3 in Fig. 1). The remedy is to insert a fixed capacitor between the two terminals as indicated by  $C_x$  in Fig. 1. The added capacitor may be about 25  $\mu$ fd.

It may be preferable to cut out the "gimmick" by breaking the coil lead with a penknife and using a 47  $\mu$ fd. or slightly larger fixed capacitor in its place. There is no chance that the "gimmick" can change its value again after this is done. Instead of a fixed capacity, a variable trimmer ranging from about 3 to 80  $\mu$ fd. may be used. Fig. 2 shows such a trimmer across terminals 1 and 3 of the oscillator coil. Adjust the trimmer screw until the oscillator starts working and then turn in the screw (increasing capacity) about a turn and a half. More capacity must be provided than just enough for the oscillator to start.

Another reason for removing the "gimmick" completely after inserting a conventional capacitor is that the "gimmick's" additional capacity may cause the oscillator to "squeg." This occurs if the grid capacitor or grid leak resistor is too large. (The grid leak resistor can be checked with an ohmmeter. If it is considerably larger than the schematic demands, replace the resistor.)

If a bypass capacitor is used from the filament of the oscillator tube to chassis or "B-" as shown in the oscillator circuit of Fig. 3, it can cause erratic oscillation. This is  $C_{20}$ , .05  $\mu$ fd.

Try shunting it if oscillation is erratic. If it is replaced, be certain to remove the old capacitor.

### "Loopsticks"

The trend has grown to the use of ferrite-core "Loopsticks" as a substitute for air-core loop antennas. The modern "Loopstick" is far more sensitive and selective due to its higher "Q." However, in a set using a "Loopstick," more care must be exercised in the tuning of the r.f. trimmer than was required for the air-core loop antenna with its broad response. For this reason, use care in replacing the leads to the antenna so that they maintain the same dress as before. Check the r.f. trimmer adjustment at about 1400 or 1500 kc. after any work on a chassis using a "Loopstick."

Particular attention should be given to mounting a "Loopstick" when it replaces a conventional loop—a desirable and feasible job when an older model portable is being serviced. The "Loopstick" should not come closer than an inch to any metal object. Mount the "Loopstick" so that it cannot wobble or shake; this causes "fluttering" as the set is carried or moved. This rigidity also applies to the leads from the "Loopstick" to ground and to the r.f. stator plate of the tuning capacitor.

Portables already equipped with ferrite-core loop antennas may give trouble due to the fact that this antenna may have too much minimum capacity for the circuit. This is particularly true of the long slender type of antenna shown in Fig. 4. This antenna stick was removed to service a complaint of poor high-frequency response. Some wire was removed, and the turns were spaced farther apart lowering the self capacity of the coil. In addition, the wire shown running along the coil was dressed away from the coil. These modifications and dressing the leads away from metal, particularly the lead to the stator plate of the

variable capacitor, enabled the set to tune nicely to 1650 kc., above the high frequency end of the broadcast band.

Optimum spacing of the turns in an antenna for minimum self capacity is about the width of a turn. This spacing is most important at the "hot" end of the coil, i.e., the end that is connected to the stator plates. Do not disturb any turns under the coupling coil if the portable uses a transistor oscillator since the low impedance input must be maintained.

When installing a "Loopstick," see that it is not shielded by metal. This includes the chassis frame, the speaker, and the batteries. The antenna should have as much clearance from metal objects as possible along its axis (length).

Fig. 5 shows a "Loopstick" with an adjustable core. The core is a ferrite slug for tuning the "Loopstick." The preferred frequency at which to adjust the slug core is about 900 kc. The slug should be adjusted so that reception sensitivity is about the same at 600 kc. as at 1000 kc. in those sets not equipped with an r.f. paddler—and few are! Adjust the high-frequency trimmer on the gang capacitor in a manner similar to oscillator alignment, i.e., tune the low frequency paddler or slug, then the high, then readjust the low, then back to high, repeating the cycle until the best results are obtained. Always stop with a high frequency adjustment. In no case should the oscillator trimmer be adjusted.

An alternative to the preceding method for tuning the r.f. precisely is to bend the end plate sections of the ganged tuning capacitor. This can often help appreciably at the high frequency end when the desired minimum capacity is difficult to obtain.

### Power Supply Troubles

During power line operation, the filament supply of a three-way portable  
(Continued on page 86)

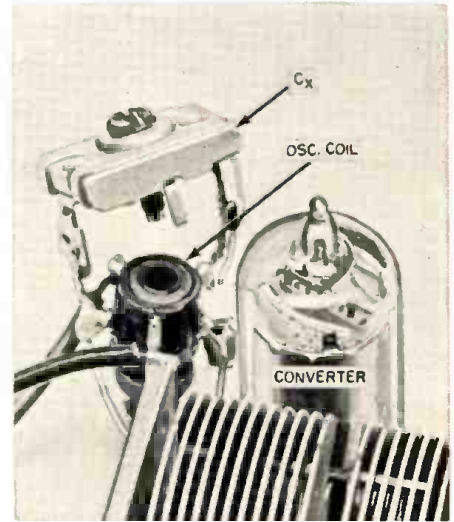

Fig. 2. Shown here is the addition of a trimmer capacitor to an oscillator coil to replace the "gimmick" which was formerly used for grid coupling. See text.

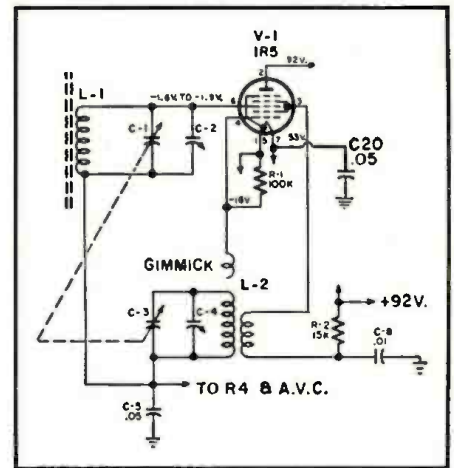

Fig. 3. Oscillator circuit of the Emerson model 830B portable. Note that the a.v.c. is applied to the frame of the variable capacitor; accidental application of a positive voltage to the frame makes the oscillator behave erratically.

Fig. 4. Ferrite core coil used with a transistor set. Note low-impedance coupling coil—do not disturb turns under it.

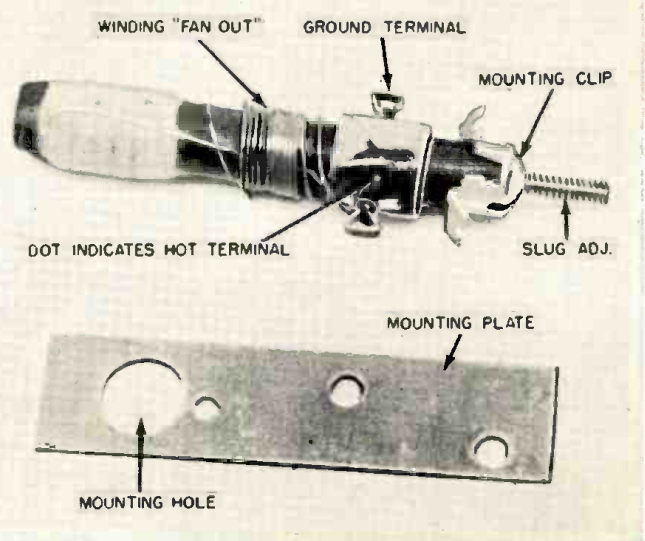
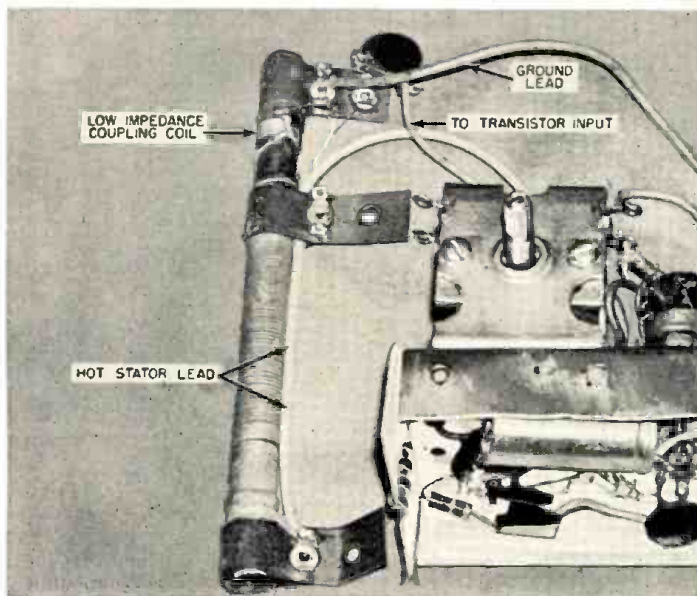

Fig. 5. Adjustable "Loopstick" shown with a mounting bracket to replace an air loop.

# A Portable

By  
**LOUIS E. GARNER, JR.**

## Ultrasonic Protection System

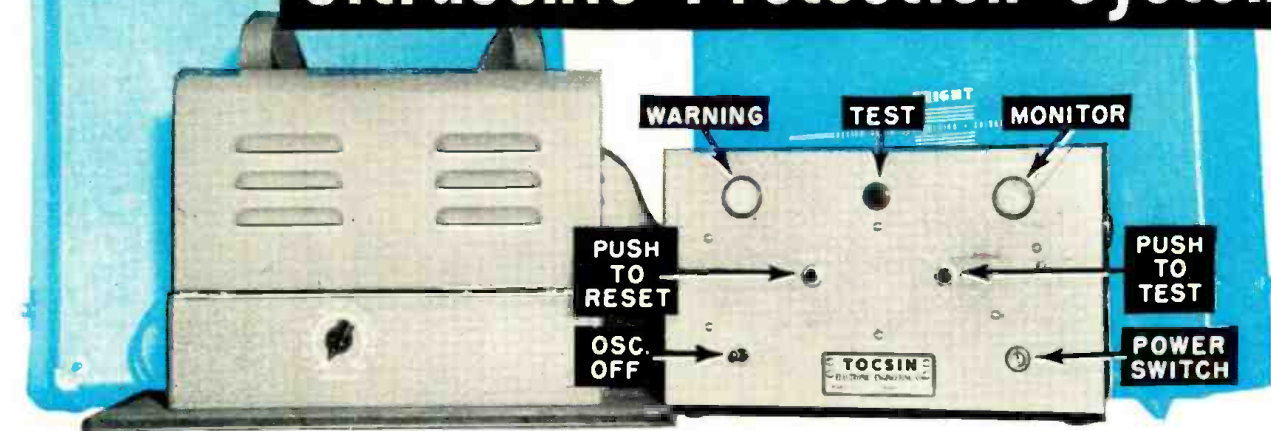

Fig. 1. The complete ultrasonic protection system can be housed in a compact, portable p.a. system type carrying case. The unit at the right is the portion of system installed at guard's station.

*Details on a compact and foolproof unit which can be installed by a novice and used by untrained personnel.*

**M**OST intruder protection systems, whether of the photocell type, the foil and door contact type, or of the capacitance type, require considerable installation time. To properly protect a room might require hours, or even days, of careful installation and wiring by a crew of skilled men. Under such conditions, it is naturally impractical to install a system to protect a specific area for only one night or one week.

However, a complete protection system can be contained in an amplifier carrying case which can be transported by one man. The component units comprising the system are shown in Fig. 1.

The system shown in the photo may be installed by an unskilled man and may be used to protect a room up to 20,000 cubic feet capacity, with the total installation time seldom exceeding a half-hour! In addition, in contrast with many systems where much of the material used is irrecoverable, the complete system can be salvaged and re-used as often as desired.

Thus, for the first time, it becomes feasible to protect a room for a single night (although the system may be left in place for semi-permanent protection

running into weeks or months, if desired). Applications are numerous. It may be used to protect a conference room during a period of classified conferences, may be used to protect a display room temporarily during showings of expensive jewels or furs, may be used to protect a drafting room during the preparation of classified drawings or sketches, in short, in any application requiring the maximum in protection "on a moment's notice" and without the need for a permanent installation.

In addition, as we shall see, protection is achieved within the entire area of the room, not just around the doors and windows. Thus, it is impossible for a potential thief or agent to secrete himself within the protected area during unprotected hours, and then to gain access to either material or information while the room is under protection. A body moving anywhere within the protected area is immediately detected and an alarm given at the remote guard location.

### Units in System

The complete system consists of four individual units, as shown in Fig. 1. All are contained within the carrying case as shown with two of the

units mounted permanently within the "halves" of the case.

An ultrasonic transmitting transducer pan is mounted in one half of the case, while a similar receiving pan is mounted in the other half of the carrying case, in the positions normally occupied by loudspeakers.

All the electronic circuits necessary to the operation of the system are contained in the amplifier foundation shown at the left in Fig. 1, while the remote "guard panel" is shown at the right.

The four units comprising the system can be interconnected easily and quickly by means of plug-in cables, so designed that no error can be made in connecting the units, even by an inexperienced man.

In the view of the guard panel shown in Fig. 1 (right), all the controls used by the guard in supervising and operating the system are easily identifiable in this illustration.

### Principle of Operation

The protected room is literally filled with ultrasonic vibrations emanating from the transmitting transducer pan. The frequency of operation is approximately 19 kc., well above the audible range. At this frequency, the wavelength is a fraction of an inch so that every surface in the room acts as a reflector. The multiple reflections thus formed actually fill every "nook and cranny" in the room.

These ultrasonic vibrations are, in turn, detected by the receiving pan and the frequency of the received signals

compared with those of the transmitted signals.

As long as the two signals have the same frequency, as will always be the case under normal operation, no alarm is given. Should there be a moving body within the protected area, however, a Doppler shift in frequency will occur, and the frequency of the received signal will no longer be the same as that of the transmitted signal. The difference in frequency is detected and an alarm given.

In practice, the sensitivity can be set so that even "waving a hand" anywhere within the protected room will give an alarm.

### Circuit Description

The complete schematic diagram of the electronic circuits necessary for the operation of the system is given in Fig. 2. The power supply circuit is not shown, since a conventional supply using RC filtering and full-wave rectification is employed.

Ultrasonic signals are generated by the series-fed Hartley oscillator  $V_1$ . These signals are applied to the transmitting transducer by coupling directly to the oscillator transformer  $T_2$  by means of a secondary winding on the transformer. Low impedances are used to minimize loss over the shielded cable connecting the transmitter to the main chassis.

A small portion of the ultrasonic energy is coupled to a diode mixer through capacitor  $C_{16}$ .

Ultrasonic energy within the protected area is detected by the receiving or "pick-up" transducer and the electrical signals thus produced fed to the shielded input transformer  $T_1$ . The

higher amplitude signals appearing across the secondary are applied to the grid of resistance-coupled amplifier  $V_1$ .

$V_1$  is a two-stage resistance-coupled amplifier with signals appearing across  $R_2$  being applied through  $C_8$  to the grid of the second stage.  $R_6$  is used as a sensitivity control, as we shall see later, but is relatively ineffective at the 19 kc. signal level due to the bypass action of  $C_5$ .

Further amplification of the ultrasonic signal occurs in the second stage, with the amplified signal appearing across  $R_5$ .

$R_3-C_2$  and  $R_7-C_{12}$  provide the conventional cathode bias for the amplifier stages, while  $R_1-C_1$  provides plate decoupling for these two stages.

The ultrasonic (19 kc.) signals are not applied to  $V_3$ , because  $R_8-C_{13}$  form a low-pass filter. Rather, these signals are applied through  $C_6$  to a high-pass filter consisting of  $C_6$ ,  $R_9$ ,  $C_7$ ,  $R_{10}$ ,  $C_8$ , and  $R_{11}$ . Finally, the picked-up ultrasonic signals are mixed with the signal obtained from the oscillator (through  $C_{10}$ ) by the diode mixer in  $V_4$ .

As long as the picked-up ultrasonic signal and the locally generated signal have the same frequency, no beat note is produced by this mixing action.

Should there be a moving body within the protected area, however, a Doppler shift in frequency will occur and the picked-up signal will no longer be the same as the transmitted signal. Under these conditions, a beat note, consisting of both sum and difference frequencies, will occur due to the mixing action of the diode in  $V_4$ . The difference is generally less than 100 cps.

The difference signal is applied through a low-pass filter network con-

sisting of  $R_{12}$ ,  $C_{10}$ ,  $R_{14}$ , and  $C_{11}$ , through capacitor  $C_{22}$  where it appears across  $R_1$ . The low-pass filter eliminates any possibility of either the 19 kc. signals or the sum frequency signals being applied over this path.

Thus, the low frequency (less than 100 cps) as well as the high frequency (19 kc.) signals are both amplified by the two-stage resistance-coupled amplifier  $V_1$ . The "sensitivity control,"  $R_6$  is effective only as far as the low-frequency signals are concerned, however (except when near the ground end of its travel). Using a tube or stage to provide two functions, as in this manner, is known as "reflexing." (Note: "Reflexing" used to be quite popular in the design of receiver circuits, and is still used extensively in European design.)

Amplified low-frequency signals appearing across  $R_5$  can be applied through  $R_8$  and  $C_{14}$  to the grid of one-half of  $V_3$ . Further amplification takes place in this stage, with the amplified signal appearing across  $R_{18}$ .  $R_{17}-C_{15}$  provide conventional cathode bias for this stage.

The signals across  $R_{18}$  are applied through  $C_{16}$  to the small selenium rectifier  $SR_1$ , where a bias proportional to the amplitude of the low-frequency signals is developed, appearing across  $R_{20}$ .

$R_{19}-C_{18}$  provide filtering so that pure d.c. is applied to the grid of the second half of  $V_3$ . In addition, the time constant of  $R_{19}-C_{18}$  is such that there is a slight delay both in the application and the removal of the bias developed in this manner.

The second half of  $V_3$  serves as the "alarm relay" control tube. Under nor-

Fig. 2. Schematic diagram of the transmitting and receiving transducers. A conventional power supply is required but not shown.

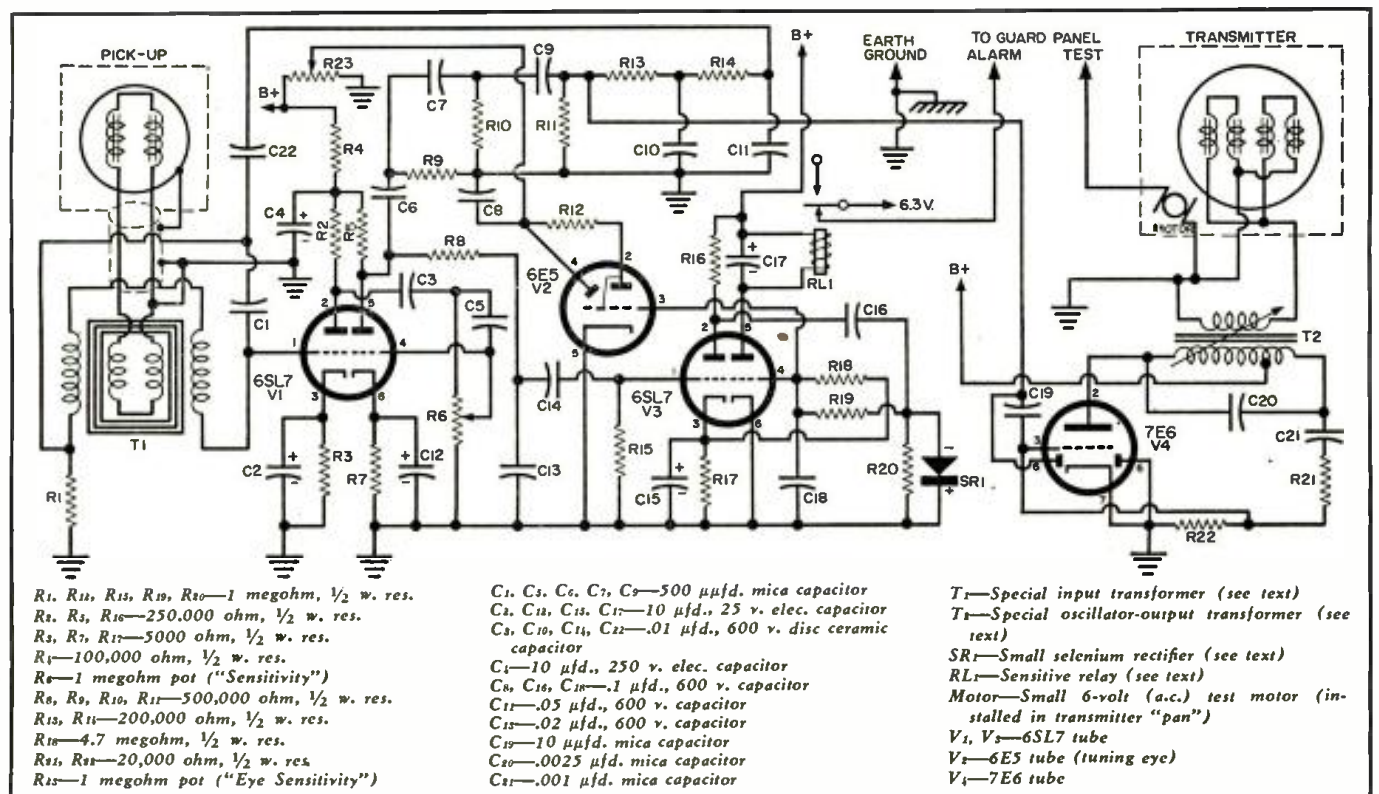

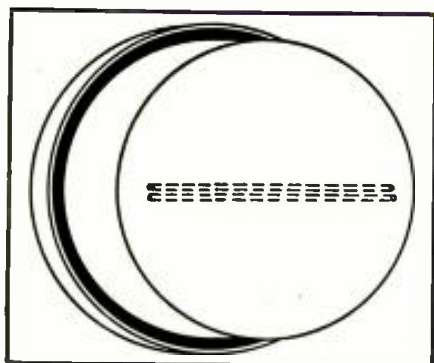

Fig. 3. Schematic representation of transducer pan. See text for full explanation.

mal operation relay  $RL_1$  is kept closed by the plate current of this tube. Sufficient plate current to keep the relay closed is assured by the slight positive bias obtained across  $R_{17}$  and applied through  $R_{18}$  to the grid of the control tube. Capacitor  $C_{17}$  is used to prevent relay "chatter."

When a low-frequency beat note signal is produced by movement within the protected area, the bias developed across  $R_{20}$  cancels the small positive bias applied to the grid of the relay control tube, permitting the relay to drop out, and thus initiating an alarm.

The design is thus self-supervising. Should  $V_s$  burn out, or the relay control open, or the power supply fail, or an attempt made to switch the protection system "off,"  $RL_1$  will drop out, giving an alarm.

Tuning-eye tube,  $V_2$ , is connected to the grid of the relay control tube and thus acts, to monitor the voltage applied to the grid. Used in this fashion, it permits adjusting the sensitivity of the system to the desired point when making an initial installation, without need for connecting the remote guard panel.

$C_6$  acts to bypass a.c. signals to prevent their application to  $V_2$ .  $R_{23}$  is used to adjust the voltage on  $V_2$  and thus serves both as an "eye sensitivity" and "eye brightness" control. This adjustment is made during the initial assembly of the system and need not be repeated as installations are made. The system "sensitivity control," on the other hand, is adjusted for each installation.

### Transducer Operation

The receiving transducer consists of a pair of nickel magnetostriction rods mounted on a cylindrical aluminum

pan approximately  $6\frac{1}{2}$ " in diameter and 2" deep. A coil of fine enameled wire is wound directly on the rods. Coupling between the magnetostriction rods and the front of the pan is accomplished by means of small metal brackets, designed to be a quarter wavelength long (mechanical) at the frequencies involved, and thus to give a good impedance match.

The schematic representation of the transducer pan is given in Fig. 3, with the magnetostriction rods shown dotted.

The transmitting transducer is similar, except that a double pair of magnetostriction rods are used. The pan itself is the same size.

In operation, ultrasonic electrical energy applied to the coil of the transmitting transducer changes the magnetization of the nickel rod, causing minute changes in the length of the rod. These mechanical changes are, in turn, transmitted to the face of the pan by means of the quarter wavelength brackets. From here the pan face vibrations are changed into ultrasonic vibrations in air.

At the receiving transducer, the operation is just the opposite. Ultrasonic vibrations striking the face of the pan are transmitted as mechanical vibrations to the magnetostriction rod. Changes in the length of the rod cause changes in the magnetization which, in turn, result in flux linkages producing an electrical ultrasonic signal in the coil wound on the rods.

To increase the efficiency of operation, the nickel rods are given a permanent magnetization "charge."

### The Guard Panel

The guard panel is used to give a remote indication of conditions within the protected area and, as we shall see later, also to provide means of remotely testing the operation and efficiency of the entire system. An exterior view of the guard panel is given in Fig. 1, while the complete schematic diagram of this portion of the system is shown in Fig. 4.

Referring back to the schematic diagram of the main chassis, given in Fig. 2, we see that when relay  $RL_1$  is closed, 6.3 volts (a.c.) is applied between the "alarm" line and earth ground. This voltage is obtained from the filament winding of the power transformer in the main chassis. This is the condition for normal operation. Should an alarm

occur,  $RL_1$  opens, removing this voltage from the line. The voltage will also be removed should the power source at the main chassis fail, or should someone cut or short the alarm line. Thus, the line between the guard panel and the main chassis is, itself, supervised against tampering.

At the guard panel (Fig. 4), the 6 volt a.c. signal obtained from the alarm line is applied to a small bridge rectifier (standard instrument rectifier). The d.c. thus obtained is applied through  $R_{24}$  to the guard panel alarm relay  $RL_2$  and holds this relay energized.

$R_{24}$  is chosen so that the current normally flowing through the relay coil is sufficient to hold the relay closed, but not sufficient to energize it, once opened. This resistor can be shorted by push-button switch  $S_1$ , which acts as a "push-to-reset" switch. This makes it necessary for the guard to go to the panel and push the reset switch whenever an alarm occurs, thus preventing a lazy guard from ignoring the alarm.

While  $RL_2$  is closed, 6 volts, obtained from transformer  $T_3$ , is applied to  $PL_2$ , the green bullseye, "normal" or the "Monitor" light. (See Fig. 1.)

When an alarm occurs,  $RL_2$  is de-energized, opening the "Monitor" light circuit, allowing this pilot to go dark, and closing the  $PL_3$  red "Warning" or "alarm" light circuit, lighting this pilot. At the same time, the alarm buzzer or bell,  $B$ , is activated, so that both a visual and an audible alarm is given.

While the guard panel is in alarm, the buzzer can be silenced by throwing switch  $S_2$ , but the buzzer will immediately sound again when the panel is set up for normal operation. Thus, it is impossible for the guard to so silence the buzzer that it will not sound when it should.

A switch operating in this fashion is called a "compulsory silence" switch.

### Remote Testing

Unlike many protection systems, the operation of the complete system may be tested remotely at any time from the guard location. After testing, the system can be set up immediately for normal operation. The tests can be performed as often as desired.

To test the system,  $S_3$ , in the guard panel, is closed, lighting the amber "Test" pilot light, and applying 6 volts a.c. between the "test line" and ground.

This voltage, in turn, operates a small motor located in the transmitting transducer pan (refer back to Fig. 2). Attached to the motor is a small vane which sets up the necessary disturbance to initiate an alarm.

Such a system works well, using ordinary telephone line, for distances up to about 250 feet. At greater distances the line drop in the "test line" requires that a small "test" relay be mounted on the main chassis. The "test" relay is then energized by the voltage applied to the test line and, in turn, ap-

(Continued on page 121)

Fig. 4. Schematic and parts list covering the "guard panel" position of system.

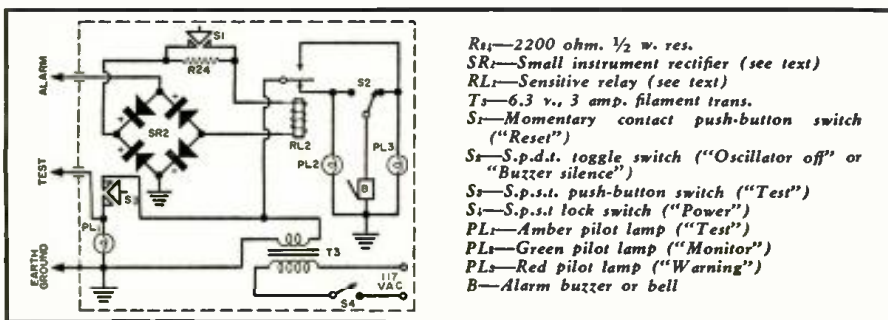

# Commercial Aspects of Single-Sideband

By **JACK N. BROWN**  
Engr., Barker & Williamson

**T**HUS far in this series little has been said about single-sideband receivers. It has been inferred that the same problems that haunt the single-sideband transmitter also plague the single-sideband receiver. The stability of the single-sideband receiving system must be identical to that of the transmitter in order to guarantee satisfactory performance. To take advantage of the reduced bandwidth transmitted by a single-sideband transmitter the SSB receiver must likewise have a restricted bandwidth. This not only increases the signal-to-noise ratio but also successfully discriminates against adjacent channel interference which might be of a serious nature.

Many modern conventional communication receivers have selectivity characteristics which are entirely inadequate for good single-sideband reception. Recently the design trend indicates that improved selectivity is in the offing and should shortly be available in many commercial receivers. The general trend is toward double—or even triple-conversion superheterodyne receivers. The steep skirt selectivity curves that are essential to good single-sideband reception are usually made available in the last i.f. stages of a multiple-conversion receiver.

Design engineers should remember that it is best to get the selectivity as close to the front end of the receiver as possible. This is often not practical, hence a reasonable compromise must be made. The current availability of mechanical filters in the 400 to 500 kc. intermediate-frequency region makes possible excellent selectivity characteristics in this part of the spectrum. Many receiver designers make use of a still lower intermediate frequency in order to obtain a rectangular selectivity curve. This last i.f. may be anywhere from 100 kc. down to 20 kc. and the filters in use under these conditions are generally identical to those used in low-frequency, filter-type single-sideband transmitters. These may be of the crystal lattice type or the toroidal coil type filter.



*Part 3. Concluding article covers SSB receivers, service procedures, test equipment, and an evaluation of system.*

If selectivity is obtained at a second intermediate frequency it should be kept in mind that the overload characteristics of the first i.f. amplifier must be such that adjacent channel signals which do not fall in the passband of the last i.f. filter must not overload and cause intermodulation distortion products which would appear at the receiver's output. In general, this means that any amplifier, whether r.f. or i.f., which precedes the high-selectivity filter must be run at a reasonably low level so that signal voltage will not rise to a high enough level to cause intermodulation distortion. Once selectivity is obtained, normal high-gain stages may be used in order to achieve the final output level desired.

AM receivers can be successfully converted for SSB reception by the addition of an external adapter. This accomplishes double-conversion to a low intermediate frequency. The converted signal is then passed through a bandpass filter for increased selectivity, demodulated by beating against the carrier oscillator, and then amplified in the audio stages. See Fig. 1 for a block diagram of such a unit.

### Single-Sideband Detection

Following the single-sideband receiving filter and amplification there must be a single-sideband demodulator with a carrier re-insertion frequency of high enough amplitude to achieve exalted carrier detection of the single-sideband signal. Some form of product detector<sup>1</sup> may be used if

high carrier re-insertion voltages are not available. If an exalted carrier voltage of over ten times the peak value of the received single-sideband signal is available, either diode detection or mixer type demodulation may be used with little choice as to which is better. Whichever system is used, a low-pass filter must be employed to prevent the re-inserted carrier frequency voltage from getting into the audio amplifier stages.

### Transceiver Type Installations

A transceiver-type single-sideband system is one in which transmission and reception is accomplished on the same frequency. It is possible to use the same injection frequency signals in both the transmitter and receiver heterodyning systems. This offers the advantage of always keeping a receiver and transmitter on exactly the same frequency. In addition, once the operator receives a distant single-sideband signal he knows that he is transmitting on exactly that same frequency. This is an obvious advantage for "netting" a group of single-sideband stations.

It is also possible to design transmitter and receiver circuits which are truly bilateral in operation so that the same components can be used, alternately, for both transmitting and receiving. This is a fairly complex problem and for the sake of circuit simplicity is not recommended where space and power limitations permit unilateral type equipment.

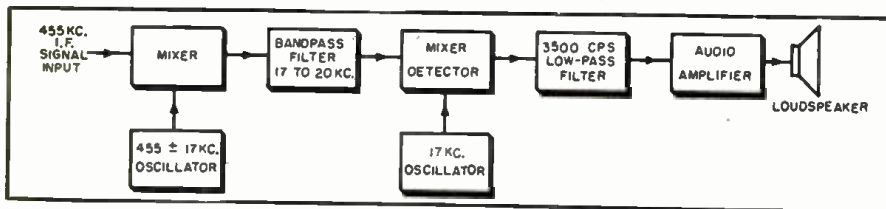

Fig. 1. Block diagram of a double-conversion type single-sideband receiving adapter which can be used to convert AM receivers to single-sideband operation.



Fig. 2. B & W Model 370 double-conversion SSB receiving adapter. The block diagram of unit is shown in Fig. 1 directly above.

### Servicing Single-Sideband

For the organization that proposes to furnish single-sideband communications to a group of customers, the servicing problems involved are of a slightly different nature than for conventional AM equipment. Such service functions as periodic checks of vacuum tubes, power-supply voltages, and operating circuits will be similar to those performed on the older type equipment. Such items as alignment of phase-shift networks, checking distortion products, sideband suppression and peak-power output measurements are all problems that undoubtedly have not confronted the service engineer to date.

To properly service single-sideband equipment a few specialized pieces of test equipment will be required. Such equipment as a spectrum analyzer, a counter-type frequency meter, good r.f. vacuum-tube voltmeters, low-distortion audio oscillators, and a good test oscilloscope should be numbered among the pieces of test gear available to the technician. The photograph of Fig. 3 shows a typical test setup.

### The Spectrum Analyzer

A panoramic-type spectrum analyzer is desirable for making initial alignments and periodic checks of single-sideband equipment. Such an instrument is manufactured by *Panoramic Radio Products, Inc.*<sup>2</sup> An appropriate model would be the Model SB-8A, type T-200. This unit allows the technician to examine the spectrum transmitted

by a radio transmitter and permits the operator to observe the output frequency  $\pm 100$  kilocycles. If he wishes to examine in detail the sideband components transmitted, he can do so by expanding the sweep to include the portion of the spectrum immediately adjacent to the signal being observed. In this case it is possible to separate sideband components which are only a few hundred cycles apart by increasing the resolution of the last i.f. amplifier of the spectrum analyzer.

The photographs shown in Part 1 of this series were taken from the screen of such an instrument. The operator has the choice of logarithmic or linear amplitude display of the signal and may read, directly in decibels, the level of the distortion products generated and of the intelligible suppressed sideband components being transmitted by the single-sideband equipment under test. To use such an instrument it is necessary to have a source of stable r.f. voltage, preferably from a stable signal generator, which must be fed into the spectrum analyzer at a frequency which is 500 kilocycles removed from the signal being observed. This is because of the i.f. and heterodyning system used in the spectrum analyzer, that is, the first i.f. amplifier frequency is at 500 kilocycles.

The variable selectivity is obtained by conversion to a second i.f. of 262 kc. where a double-section crystal filter is used. This filter bandpass is variable to accommodate various sweep widths and resolutions desired. An instrument of this type is invaluable to the technician in testing single-sideband equipment.

### Frequency Measuring Equipment

Since frequency stability is of prime importance in single-sideband equipment, it is obvious that some means of measuring radio frequencies in the high-frequency spectrum must be available to the technician. The newer-type decade counters, currently available on the market, are ideal for this task. Such decade counters are manufactured by *Beckman Instruments*<sup>3</sup>, *Hewlett-Packard*<sup>4</sup>, and others.

The direct-reading frequency meters are so convenient that the advantages of using such gear are too obvious to mention. Using such an instrument permits the technician to check, in a matter of seconds, the exact frequency of the transmitter under steady or discontinuous type transmissions. If any instability exists it is quickly detected and the technician can, by the process of elimination, determine

which of the various heterodyning oscillators is causing the trouble.

### Audio Oscillator

The use of a low-distortion audio oscillator is very necessary in making distortion product measurements on a single-sideband transmitter. Distortion on the order of one-half of one percent or less is necessary in order to make intelligent distortion measurements on a single-sideband transmitter.

In making a two-tone test to check the linearity of the amplification system of a SSB transmitter, it is generally acceptable to use re-inserted carrier and one audio tone fed into the audio amplifier to make up the two tones for the linearity test. When both tones are equal in amplitude and the output of the transmitter is monitored on an ordinary oscilloscope, the pattern shown in Fig. 4 will be seen. This is not to be confused with the pattern for 100% modulation that is normally seen on a conventional AM transmitter. If any flattening of the peaks of Fig. 4 is apparent, the amplifiers are being overdriven or are seriously under-loaded as far as the output circuit is concerned. If the crossover shape at the center of the scope pattern is not a sharply defined "X", the bias on one or more of the amplifier stages is misadjusted and therefore should be decreased to avoid operating on the "knee" of the tube characteristic curve. By simple observation of the output envelope of a single-sideband transmitter it can often be quickly determined which of the various sources of distortion is causing trouble.

Observation of the transmitter output by a spectrum analyzer, however, will not tell the exact cause of the distortion products but will only tell to what extent distortion products are being generated. Therefore, it is necessary to use both the spectrum analyzer and oscilloscope observation of the transmitter r.f. output envelope.

Using the oscilloscope to observe the normal operating output waveform is also necessary when adjusting any automatic modulation level control or speech clipper circuit. This should be set conservatively so that restriction of the maximum swing of the transmitter output is just short of the maximum range available on peak output power. The slight amount of audio distortion that is inherent in a speech limiter or speech clipper is tolerable. If conservation of spectrum space is to be accomplished with single-sideband techniques, proper use must be made of all spectrum limiting circuits.

### Operational Problems

The main operational problems that will confront the user will be during the transition period when both AM and single-sideband equipment may be in use by subscribers using the same or adjacent channels. If it is possible to convert all stations of an operating system to single-sideband simulta-



neously, the main operating difficulties would be avoided. This will not always be possible and therefore it will be necessary to operate single-sideband and conventional AM transmitters in the same network and on the same frequencies.

It should be obvious to the engineer that single-sideband equipment can be used for receiving AM signals if the AM signal itself has a frequency stability that meets the stability requirements of the single-sideband system. The single-sideband receiver operator has the advantage of being able to select either sideband of the transmitting AM station in the event of interference so that he may be in a better position to copy the AM signal than another AM-equipped receiving station. Under many conditions an AM-equipped station will find it impossible to copy a single-sideband transmitter without some special provisions being made. Such provisions may include an artificially inserted carrier in the AM receiver either by use of a beat frequency oscillator (b.f.o.) or by the addition of a single-sideband receiving adapter on the tail end of the AM receiver. Such adapters (Fig. 2) are currently available for receivers using standard intermediate-frequency systems. These offer selectable sideband reception with excellent selectivity characteristics.

It would also be possible, in many cases, for the single-sideband transmitting station to re-insert carrier and transmit single-sideband with carrier so that the receiving AM station could properly demodulate the signal in a conventional manner without the use of any special SSB receiving techniques. This would appear to be the easiest system for utilizing both single-sideband and AM equipment in the same net. This, however, has the disadvantage of compelling the SSB operator to run lower than normal power output when using single sideband-suppressed carrier. This is so because when he transmits a carrier with his SSB signal the power capabilities of the linear amplifiers are greatly reduced by the presence of the continuous carrier. Generally, if a transmitter is rated at 100 watts peak envelope output under normal SSB transmission the operator will find that he will be able to run only 30 watts output using carrier with one sideband. This is a rather obvious disadvantage as far as the SSB operator is concerned. He is no longer making maximum use of the equipment as designed for SSB service.

Another operational problem that will undoubtedly arise when using single-sideband equipment is the problem of "netting" a group of SSB stations when using the same frequency. Normally, under fixed-frequency commercial-type service crystal-controlled equipment would be used. A small amount of frequency vernier control should be made available at the front panel of the transmitter-receiver equipment. If the single-sideband equipment



Fig. 3. Test position used to align sideband generator units. Equipment visible in photo includes a decade frequency meter, audio oscillator, receiver and SSB receiving adapter, and panoramic spectrum analyzer with a signal generator.

is of the transceiver type, both the transmitter and receiver will be controlled simultaneously by this frequency vernier knob. If the operator adjusts the vernier frequency control so that he receives the net control station correctly he then knows that he will be transmitting on exactly the same frequency as the net control station. If each operator in the net is careful to adjust his receiver to the frequency of the net control it is then obvious that all stations are on the same frequency. If the amount of frequency vernier control is kept to less than the maximum tolerance allowed by FCC regulation (currently .01%) unskilled operator alignment of the transmitter-receiver frequency would be possible without risking off-frequency operation. It then becomes obvious that if correct net frequency discipline is to be maintained, the net control station must at all times maintain its transmitter frequency near the middle of the FCC frequency tolerance permitted for the particular class of service. For many types of service it will probably be desirable to have absolutely no operator adjustment of the transmitter-receiver frequency. This should be possible with good quality crystal control for each available channel.

### Expected Reliability

The many obvious technical advantages of single-sideband have been pointed out throughout this series. The final user is always interested in exactly how reliable a system is going to be from the standpoint of circuit outages due to weak signal conditions, equipment failure, and complexity of operation. Since very few single-sideband low-powered communication systems are currently in use the only operating experience that can be quoted is rather restricted. However, it can be stated that a correctly aligned SSB system will easily outperform a comparable AM system in all ways.

A single-sideband system will be immune to ionospheric propagation distortion. The problem of selective fading distortion that is ever present in a double-sideband AM signal is non-existent with a SSB signal. Selective-fading distortion that is caused by multi-path propagation causes the carrier to be temporarily lost or one of the sidebands to fall out-of-phase with the other sideband. The familiar garble of the intelligence results. The SSB user will find that fading of the SSB signal causes only a variation in output volume and in no way tends to

(Continued on page 94)

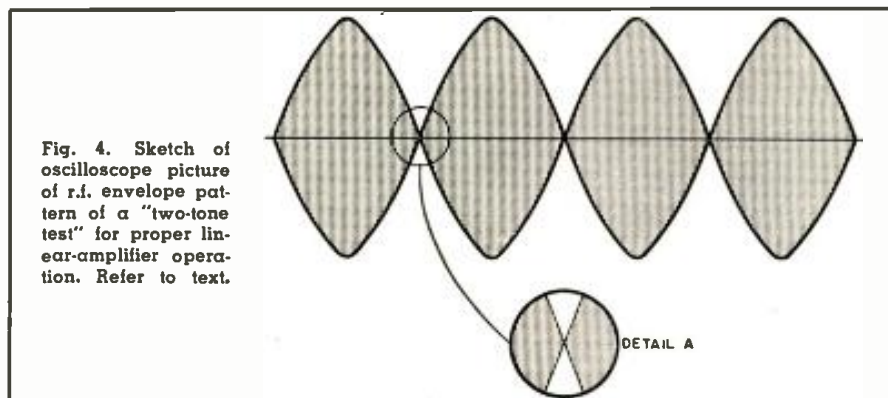

Fig. 4. Sketch of oscilloscope picture of r.f. envelope pattern of a "two-tone test" for proper linear-amplifier operation. Refer to text.

# Certified RECORD REVUE

By **BERT WHYTE**

**L**AST MONTH'S introductory notes were devoted to a discussion of three-channel stereophonic sound. You may recall that I speculated on the possibilities of making this fabulous sound commercially available to the music-loving public. I acknowledged the rather staggering problems involved in bringing this sound to commercial fruition in the form of recorded tapes and machines upon which to play these tapes. I made what I hoped were some helpful and possibly stimulating suggestions. Quite frankly, I suspected that my ideas and suggestions would lie dormant and go unheeded for some time. Long time readers of this column will recall that I got up on my soap-box and beat the drums for two-channel stereo and binaural some years ago, and the antipathy and indifference of certain people who could have brought this sound into being then was a frustrating and maddening experience. Well, two-channel stereo is now well under way, but on the basis of the rocky road it had to travel, one could logically assume that the obstacles confronting the adoption of three-channel stereo are even more formidable, and will take a longer time to resolve.

Thus armored by my experiences with two-channel stereo and anticipating nothing but a long hard fight, you can imagine my stunned disbelief and pleasant surprise when I learned that one of the major problems blocking the commercial realization of three-channel stereo was well on the way toward solution! Yes, just a scant two weeks after I wrote last month's column plugging the three-channel stuff, the light of knowledge, the dawn of realization was already breaking! Now don't get me wrong! You won't be able to trot out to your favorite audio emporium next week and bring home the three-channel bacon for \$99.50! *But*, the first big step has been taken . . . the die is cast . . . the show is on the road! What is so earthshaking? You will have to wait until next month to find out, because the report on this event requires special coverage. A monthly column rarely, if ever, has a "scoop," but I can promise you one next month. It is quite possible that for the first time in the history of this column we will use some photographs to further highlight the significance of this big step forward in stereophonic reproduction for the home. Don't miss next month's column!

Because the August column will have an extensive introductory section on the new stereo development, we may have to cut down the reviews a little. Due to that and due also to the fact that many readers are starting their vacations and will have time to catch up on their listening, this month I will try to cram in as many reviews as possible. They will be shorter than usual, but that's the only way I can bring the maximum number to you. Contrary to the practice of record companies in the summers of years past, there is very little diminishing of the flood of new

releases. Indeed, there are so many that if one were so inclined and had the money to indulge himself, every moment of a two week vacation could be spent in listening. Those who like the Dodgers instead of Dvorak, won't care . . . for the listeners I'll try to bring them the mostest!

*Equipment used this month:* New Gray turntable, Gray viscous-damped arm, Fairchild 225 cartridge, Marantz audio console, two 60-watt McIntosh amplifiers, Jensen "Imperial" speaker, Electro-Voice "Georgian" speaker. Ampex tape equipment.

## MOZART

**SYMPHONIES NOS. 36, 39, 40, AND 41**

**Chicago Symphony Orchestra conducted by Fritz Reiner. Victor LM6035. RIAA curve. Price \$7.96. Two discs.**

Here is a magnum sampling of Reiner's particular way with Mozart symphonies. And his way will find favor with many . . . not so much as impeccable performances, but as remarkable studies in orchestral textures and balance. Mozart wrote his symphonies for what amounts to a chamber orchestra and intended that they should be played in moderate sized salons. Time and circumstance have long since relegated them to the concert hall, where they have acquired larger orchestration and larger sound. Since everyone plays them thus today, Reiner cannot be taken to task, even though his is quite the biggest and most sonorous Mozart on records. The purists will prefer Beecham and Walter . . . but these are impressive performances with a vast, big-hall sound . . . yet with the inner detail clearly revealed. The orchestra plays wonderfully well, especially the strings and string tone is particularly luscious. This recording might best be characterized as "Mozart for the Hi-Fi Fan!" In any case, a creditable job and a good buy.

## A HI-FI FROLIC WITH STRAUSS

**Vienna State Opera Orchestra conducted by Anton Paulik. Vanguard VRS476. RIAA curve. Price \$3.98.**

The Strauss in this case as you may have guessed is Joseph and Johann and even lesser-known Eduard, but certainly not the formidable Richard! No one would dare be that frivolous with him! This is one of *Vanguard's* justly famous Viennese recordings and is every bit as good as "Vienna Bon-Bons" and the others that have been released. That past master of the bubbling, frothy Strauss music, Anton Paulik, again holds forth with rousing performances of ten polkas, a "Galop," a "Scherzo" and a lilting "Blue Danube." Superbly clean sound in keeping with the tradition of earlier recordings in this series.

The opinions expressed in this column are those of the reviewer and do not necessarily reflect the views or opinions of the editors or the publishers of this magazine.

A frosty glass, a pretty lass, and this music adds up to a summer night delight.

**FOLK SONGS OF THE FRONTIER**  
**The Roger Wagner Chorale and soloists. Capitol P8332. RIAA curve. Price \$3.98.**

Well podnuh, this heah disc is yore ticket effen you is a-hankerin' for some cowboy ditties. Yessir, this has got 'em all, from "Home on the Range" and "O Bury Me Not on the Lone Prairie" to "Whoopee-Ti-Yi-Yo" and others. Seriously this is magnificent choral work, with all the colorful words completely articulate and with splendid balance between the various choirs and the soloists. *Capitol* affords the performers very wide range, ultra-clean sound and, with the utterly dead quiet surfaces, the illusion of presence is uncanny.

## BALLET MUSIC FROM THE OPERAS

**Philharmonia Orchestra conducted by Herbert von Karajan. Angel 35307. RIAA curve. Price \$4.98.**

Von Karajan follows up his good work in last month's "Pop Concert" with this potpourri of operatic ballet music. Sure there are potboilers here and very appropriate for summer listening, especially when they are well done as on this disc. In the "Dance of the Hours," the ballet music of "Aida," the "Dance of the Persian Slaves" from "Khosrovantchina," the "Venusberg Music" from "Tannhauser" and the "Prince Igor Dances" 8 and 17, Von Karajan displays his talents for orchestral color and gives us good vigorous readings. The Philharmonia plays splendidly and the sound, another of the newer, brighter, more "hi-fi" efforts by *Angel*, is quite thrilling. Outstanding brass, strings, and percussion.

## SCHUMANN

**SYMPHONY NO. 2 IN C MAJOR**  
**Detroit Symphony Orchestra conducted by Paul Paray. Mercury MG50102. RIAA curve. Price \$3.98.**

Paul Paray scored a notable success with his reading of the Schumann 4th some time ago, and now he repeats that success with Schumann's 2nd. Many critics were surprised by Paray's performance of the Schumann 4th, a composer they obviously felt was outside of his usual repertoire. This would not be the first time that Paray has confounded the critics. He simply does not fit the classic mold the critics attribute to a French conductor. More than that, although many have questioned the authenticity of some of Paray's "out-of-repertoire" readings, none of them deny that his performances have their own strength and virtues. It is so in this Schumann 2nd. There is an extraordinary warmth, and an earthy vigor in the Paray perusal of the score, that is not matched by any of the existing recordings in the catalogue. Even in terms of sheer sound, this disc is beyond any of its competitors. The strings are smooth but quite bright, the brass crisp and the woodwinds very pure-toned. Add the spacious acoustics to the usual *Mercury* "close-up," highly detailed recording and the wide dynamics and you have the best Schumann 2nd now available.

## TCHAIKOVSKY

**SUITE NO. 3 IN G MAJOR**  
**L'Orchestre de la Societe des Concerts du Conservatoire de Paris conducted by Sir Adrian Boult. London LL1295. RIAA curve. Price \$3.98.**

Relatively little known and certainly not one of Tchaikovsky's most athletic efforts, this "3rd Suite" has much that many people  
*(Continued on page 109)*

# Realistic High Fidelity

## The Single-Cone Loudspeaker



By H. A. HARTLEY  
Audio Consultant

**D**ESIGNING high-fidelity loudspeakers is partly a science but very much a fine art. The requisite "know-how" has to be acquired the hard way—by making mistakes; in other words, the engineers who have made their mistakes and have profited from their experiences are in a position to contribute more to the industry than a newcomer. This seemingly untechnical approach is not an attack on science or straight-thinking, it is straight-thinking since a speaker cannot be designed by mathematics. It is a known fact that only the simplest actions of a speaker can be analyzed mathematically, such as an infinitely rigid diaphragm driven by a sine wave; but since musical reproduction, in all cases, results from an extremely flexible (speaking comparatively) diaphragm actuated by very complex waves, the motion of it and the sound emanating from it cannot be computed very readily. Putting it crudely, speaker design is a sort of inspired guesswork. Certain parts of the speaker, particularly the magnetic system, can be designed with great precision, but the thing that makes the noise, the voice-coil-cone assembly, cannot be treated in this tidy manner.

The home constructor and the enthusiastic amateur are at a serious disadvantage in the matter of speaker design, although many volumes have appeared dealing with the subject. Making a speaker is not easy, for in order to secure reasonable sensitivity, tolerances have to be close in the voice-coil, yet it is made from materials which do not lend themselves to fine limit construction. I shall assume, therefore, that in the matter of speakers you will buy something ready made. The problem is, therefore,

### Part 4. Design factors influencing loudspeaker performance and a discussion of the simple, diaphragm type reproducers.

*EDITOR'S NOTE: As is quite obvious, the opinions presented in this article are those of the author. Actually, there are quite a few individuals who, like the author, believe that the use of multiple small-cone speakers is preferable for high-fidelity reproduction, to a large, single-cone unit. There are several facts that validate this thought. On the other hand, you will find many other individuals, including most U. S. speaker manufacturers, who believe the larger cone unit is the ultimate answer. They, too, can present reasonable arguments for its use. Some of these facts are obvious. Although the author has shown that, theoretically, the bass response of a small-cone speaker can be made as good as a large-cone speaker, the large voice-coil and cone excursions required present major manufacturing and performance difficulties. As a result, we do know that, considering present-day techniques, the bass response extends farther down (frequency-wise) as the cone size increases. On the other hand, the smaller speakers provide better coverage of the high end when compared with the larger single-cone speakers. For greatest frequency range, it is usually necessary to use a combination of one large-cone woofer and a high-frequency tweeter.*

which speaker to buy and how to use it.

#### Visual Assessment

Strange as it may seem, the performance of a speaker can be fairly well estimated merely by looking at it, if you know what to look for. This is due to the fact that experienced designers know that such and such an assembly of materials produces certain sounds and has certain defects (for no speaker is perfect). The wider the experience the more certain is the work of the designer, but it does not follow that a given manufacturer produces some specific model because the designer wanted it that way; the man who usually fixes the design is the sales manager, whether he is selling loudspeakers or automobiles. Fashion trends are created by advertising experts and the public trained to accept these fashions as the thing they ought to have. New ideas are created by original thinkers and competitors rush in as soon as the new feature has proved to be a seller and copy it, without having any clear notion of what

they are doing. Others know full well what they are doing, but for the sake of novelty christen an accepted design feature with a new name.

I speak from direct experience of this sort of thing. Many years ago I came to the conclusion, after innumerable experiments, that the optimum cone size for an honest-to-goodness high-fidelity speaker was between 8 and 9 inches in diameter, according to the material used for the cone. That conclusion was forced on me by purely objective research. I have produced speakers having cones of this size for 25 years and they are well liked by those who have them; but my dealers tell me they could sell many more if it were a 12-inch speaker. What am I to do? Tell them, as I have been telling them for years, that if they want more power-handling capacity and more sound output they should use two or three of them or sacrifice performance to meet the requirements of a whimsical market? Actually my task now is to find out how to increase the size of the cone without spoiling the per-

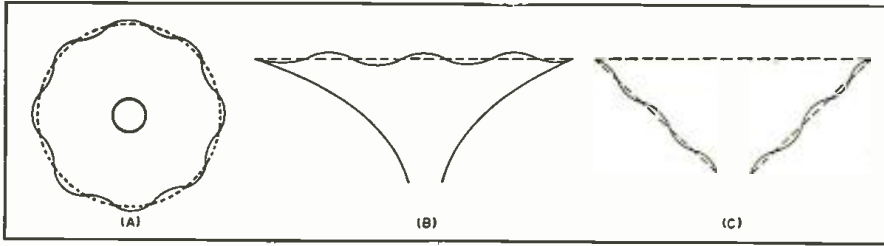

Fig. 11. The distortion of speaker diaphragms at low frequencies. (A) Nodes on a straight-sided cone. (B) Nodes on an exponentially-curved cone, and (C) wave motion along the sides of a cone. Refer to text for details on this.

formance of the speaker, and that involves a complete redesign. At any rate, the 12-inch speaker remains a project and nothing else until I can find a way of making a 12-inch cone behave as I want it to.

The following discussion, like my past experiments, is objective. Many will disagree with what I postulate as to the requirements of good design, and it may be that I am biased because I am a loudspeaker designer. But I said in my introduction that this series is devoted to high fidelity considered as a means of reproducing music with as little equipment coloration and distortion added as may be possible; the speaker is the worst offender, and my thesis is based on genuine research into creating speakers that have no "personality," speakers that are not better nor worse than other speakers, but don't sound like speakers at all.

Taking direct radiators first, loudspeakers that are mounted on flat or folded baffles, the first thing you see is the cone. This has four properties having bearing on its performance: diameter, included angle, shape of cross-section on the axis, and material.

I have said that my experiments have shown that the optimum size of cone is about 8 or 9 inches. Why should this be so? Since a diaphragm is not infinitely rigid it must distort when force is applied to it from the voice-coil. Major distortions occur in three different ways, particularly at low frequencies. Assuming a free-edge cone, a straight-sided cone develops flower patterns as a result of nodes when viewed from the front under a stroboscopic light; an exponential cone develops nodes in an axial direction when viewed from the side; any cone develops transverse wave motion along the cone. These three phenomena are illustrated in Fig. 11.

Now for a given material of a specified thickness it does not require a

great deal of imagination to see that the larger the cone in Fig. 11A, the more likely will there be an inherent tendency to develop nodes. Make up two cones of the same included angle with ordinary writing paper, one having a diameter of 3 inches and the other of 6 inches. You will find that the smaller cone is less easily deformed by pushing the free edge. This lesser rigidity at the edge can be counteracted by making the larger cone of thicker or stronger material or by making the included angle narrower (thus effectively reducing the diameter of the cone). Unfortunately, in a practical speaker, this has a detrimental effect on the performance because the heavier the cone the less response in the treble, and the narrower the cone the more intense is the focusing of the high notes. Even a flat diaphragm will not give uniform spherical radiation at all frequencies and a narrow angle cone produces a highly concentrated beam for all frequencies over about 1500 cps.

You may well ask, therefore, why not let the nodes form and stop worrying? The answer to this is that energy transmitted to the cone through the medium of the voice-coil is being used up to produce the nodes in the cone instead of pushing the air in front of the speaker, and so the response at the low frequencies will be reduced. A loudspeaker with linear response converts all the applied electrical energy into air (sound) waves; none is wasted in deforming parts of the speaker. The formation of nodes must be prevented, by making the diaphragm as rigid as possible.

The first widely adopted method was to make the cone with an exponential cross-section as shown in Fig. 11B. Such a diaphragm is very rigid across a diameter, but now, as I have shown, the nodes develop in the direction of the axis of the cone. The flatter shape of the exponential diaphragm gives

less focusing of the highs, but to stiffen it circumferentially, concentric corrugations are molded in the cone. Almost every speaker you examine will be found to have such corrugations incorporated in the diaphragm. But when we consider the case of Fig. 11C, a defect which has only recently been noted by some loudspeaker designers, the circumferential corrugations are no help at all, for they give no stiffness along the material of the diaphragm.

B. F. Miessner (in a letter published in *Radio-Electronics*, May 1954, pp. 134 et seq.) explains an ingenious solution for this difficulty by cementing soda straws to the cone, like spokes in a wheel. If too many are used, the mass of the diaphragm is unduly increased, and the method, from a commercial point of view, would be very costly. The deformation in a straight-sided cone is not as great as in the flat area of an exponential cone, as you can imagine by thinking of the plane rigidity, if I may call it that, of a sheet of paper as compared with a cone; it occurred to me that if the flat part of the exponential cone could be abolished, a substantial improvement could be brought about. Experiment proved this to be the case. One solution to this problem, see Fig. 12, shows a cross-section of the diaphragm of my 215 speaker, in which the outer part of an ordinary exponential diaphragm has imparted to it a reverse curvature, so that the outer zone is itself reasonably rigid axially. Just before the flattest part the wave motion has been interrupted by the presence of points "B." The compliance (points "B") was not introduced specifically for this reason (its real purpose will be described later), but its presence does act as a barrier for the wave motion originating in the apex of the cone. What is transmitted beyond this point is neutralized by the curvature of the outer part of the diaphragm.

So far, then, it would seem that there are many snags attending the use of a large cone; why do so many loudspeaker manufacturers use them? Let us summarize these drawbacks; the large cone is heavier than a small one, so restricting the response at high frequencies; its mass is such that transient response is impaired because it is more difficult to start a heavy object moving rapidly than a light one; and its size makes it too flexible in various directions, thus causing loss of bass through energy being wasted in deforming the cone. Everything points to the use of a small cone, but the small cone has one fatal drawback—its power-handling capacity is very seriously limited.

Apart from the resistance to movement offered by the rear suspension spider and the front surround of the cone, that of the air in front of the diaphragm is substantial, as indeed it must be, since the function of the loudspeaker is to move air to create sound waves. It will be obvious that

Fig. 12. Cross-section of the Hartley 215 diaphragm. "AA" is the exponentially curved cone apex; "BB" the isolator consisting of a plastic compliance-junction. "CCCC" are the circumferentially molded ridges on cone. "DD" is a loose flannel surround to provide completely free edge. The curvature of the diaphragm between B and D is reverse of that in ordinary exponential cone.

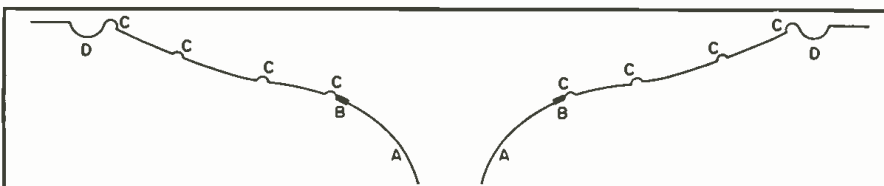

a small cone will move less air than a large one, and the air resistance to the movement of a small cone is less than that of a large one. For a given input, therefore, the small cone moves forward more easily and has less output, and because it moves more easily it reaches its limit of movement, determined by the suspension system, sooner than in the case of a large cone. This is of importance only at the low frequencies, for the amount of movement for a given input depends on the frequency of the current applied to the voice-coil. This is why a large cone is said to be better for bass reproduction than a small one, but this only holds good for a given amount of displacement of the diaphragm. A small cone can move as much air as a large one provided it has greater freedom of movement.

Fig. 13 gives a series of curves for various sizes of cones plotted against distance to be moved and frequency, on the assumption that the speaker efficiency is constant and the input and output are also constant. Actually the curves were taken from measurements with speakers of about 5% efficiency (a not unusual figure for ordinary dynamic speakers) with an input of 5 watts; this would give an acoustic output of approximately 0.25 watt. It will be seen that to maintain constant output the movement required from a 5-inch cone rises very rapidly as the frequency approaches 30 cps, whereas with an 18-inch cone the increased movement required is very small. It will also be noticed that as soon as the cone size has increased beyond 8 inches, the advantages of increased power-handling and acoustic output is proportionately much less, for the curves crowd together as the cone size increases.

Despite the fact that these articles are concerned only with high-fidelity reproduction, I maintain that what happens below 40 cps doesn't matter very much. It is almost impossible to hear a 32-cycle note but it can be felt, and I believe that to attempt to create this "feeling" is a waste of time, money and effort. Even 50 cps is a very low note and quite a high proportion of high-fidelity installations cannot reproduce it without some sort of distortion; I am certainly content to have the lower limit of my frequency range at 40 cps but it must be free from distortion. I would rather have a limit of 50 cycles without distortion than one of 40 with some distortion.

At this lower limit, therefore, a study of the curves of Fig. 13 suggests that there is not much to be gained by having a cone larger than 10 inches, for you must remember the serious disadvantages of large cones from the point of view of treble reproduction, nodding, and wave transmission along the cone itself. But you will still want to know why, in the face of this, speakers with cones from 12 inches to 15 inches are readily obtainable in any audio store. There can be no definite answer to this question. We do know

that there are many individuals and speaker manufacturers who believe that a large speaker gives "better" bass reproduction than a small unit, so the bigger and more expensive your speaker the "better" the bass. Hand in hand with this argument is the one which states that it is well known that large cones have no treble, which is why the best systems are multi-channel jobs, where a tweeter looks after the highs while the woofer looks after the lows.

Both these arguments are completely specious. The large speaker will certainly give more bass than the small one, but its larger output has more distortion, owing to nodding and wave transmission. There is the further disadvantage that the air partially enclosed by the large cone has a resonant frequency at a point which can seriously impair the reproduction by imposing a one note hoot on the whole sound coming from the loudspeaker. This you can test for yourself. Place one ear right inside the cone of the speaker and tap the cone with your fingernail. You will hear at least one low sound which is caused by the resonant frequency of the suspension. Now grip the cone-coil joint with two fingers while you tap the cone with a fingernail of the other hand and you will hear another note of higher frequency than the previous one. This is caused by the reaction of the paper of the cone on the air within it and causes the hoot I have mentioned. It is avoided by taking care that the air within the cone is not even partially enclosed, best achieved by making the cone as flat as possible, but not so flat that it allows axial nodes to develop easily, and obviously still more certainly achieved by making the cone small.

If you have a pair of musically trained ears and are listening for distortionless musical reproduction, if your ears have not been preconditioned by long bouts of listening to sound reproducers, hi-fi or otherwise, you will hear this hooting effect with any large diaphragm speaker. It has nothing whatever to do with the bass resonant frequency, it is a necessary acoustic accompaniment of a large cone. The nearest equivalent to it in the instruments of the orchestra is found in the

drums, which emit sounds at the resonant frequency of the stretched skins, but have an accompaniment in the resonance of the air inside. This effect I sardonically christened many years ago as "the characteristic sound of a loudspeaker" and there seems to be absolutely no cure but that of using smaller cones of the correct design. The question of power handling is answered by using two smallish speakers instead of one large one, perhaps a superficially clumsy way of doing it, but there is great merit in using two speakers widely spaced for they give an extremely good imitation of binaural reproduction.

Finally, we come to the question of the cone. On the face of it nothing need be said on this point as all diaphragms seem to be made of paper pulp treated with some sort of dope or varnish; but as in the next article we shall meet tweeters with metallic diaphragms, it seems desirable to point out that the material of which the diaphragm is made has a bearing on the sound emitted by the speaker, independent of frequency response. This must happen with speakers as it happens with musical instruments, the woodwinds of the orchestra sound different from the brass, the wooden pipes of the organ different from the metal pipes. These musical tubes are not diaphragms, but they are part of a vibrating system which includes air, as is the diaphragm of a loudspeaker. Speaking very crudely it might be said that wooden pipes sound "tubby" and metal pipes sound "tinny" or shrill; this seems so obvious that it is hardly worth saying, yet the obvious is sometimes overlooked in designing loudspeakers.

The cone should be acoustically inert, it should impose no coloration of its own. It is my considered opinion that the cone should be made of a very high grade Bakelite resin, containing not more than 10% of rag tissue as a binder. To make such a cone in quantities by molding is an almost impossible manufacturing proposition, owing to the danger of the molds sticking; but cones can be fabricated out of flat sheets of this material. Unfortunately only straight-sided cones can be made  
(Continued on page 135)



Fig. 13. Movement required of the various sizes of diaphragms at low frequencies to avoid bass distortion. Speaker efficiency is about 5%. Audio input is 5 watts.

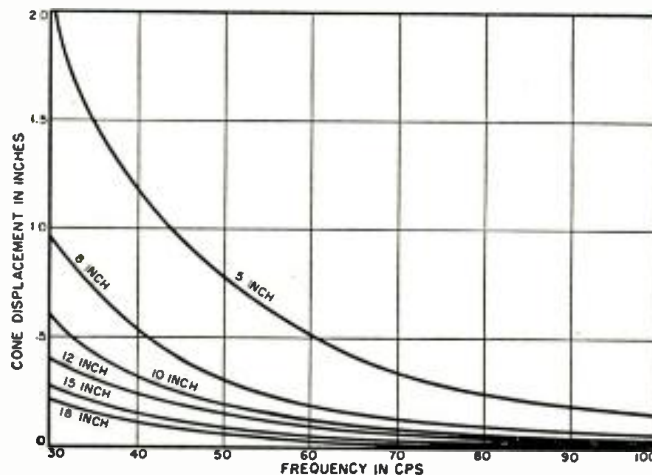

# A New Single-Gun Color Tube



Fig. 1. The Philco color TV picture tube is shown here. The bulb used is conventional.

*This is the tube that Philco has kept under wraps for over two years. It produces excellent color pictures, but receiver circuitry is not yet final.*

**F**INALLY, after more than two years of secret development, the *Philco Corporation* has divulged the principles of operation and the extent of development already accomplished on its "Apple" color TV system. At the same time, the company released information on the single-gun color tube it developed to go with this color TV system. The word "Apple" has been used by *Philco* as a code name for this system, which has been one of the best kept secrets in the electronics industry.

Basically, the tube uses a single electron gun to excite the vertical color phosphor stripes on the face plate. Instead of directing the beam to a particular color stripe in a regular switching and deflecting sequence, as the *Lawrence* single-gun tube does, the "Apple" tube allows the beam to sweep across the face of the tube as in monochrome practice but the modulating information to the beam is switched according to the position of the beam. In other words, as the beam passes over a red stripe the red signal is passed to the gun. The same holds true for blue and green. Such a principle requires an indexing system to provide information concerning the whereabouts of the writing beam and a modulating system to provide the required beam modulation.

The "Apple" color picture tube, shown in Fig. 1, may be generally described as an all-glass 21" rectangular picture tube providing 260 square inches of useful screen area, having a diagonal deflection angle of 74°, and using magnetic focusing and deflection. The color television display system described here requires a picture tube that must satisfy certain specific and unusual requirements. These are:

1. Small spot size
2. Two electron beams that "track" each other and have a minimum of "crosstalk"
3. A screen consisting of a repeating pattern of vertical red, blue, and green luminescing phosphors arranged in lines in a precisely described fashion on the face of the tube
4. A secondary emission index-producing structure as an integral part of the screen

The two fundamental parts of the "Apple" system are "sequential writing" and "electrical index." The expression "sequential writing" means that the beam passes successively over triplets of fine vertical red, green, and blue stripes, as shown in Fig. 2. A particular color is produced by modulating the beam during the time it is passing over each triplet according to the proportions of primaries in the desired color.

The expression "electrical index" refers to a signal derived from the anode of the "Apple" tube itself that continuously gives information on the location of the beam. The beam current responds to two types of instructions: the color video signal from the transmitter and the index signal.

The index signal is obtained from the tube by means of the structure shown in the insert in Fig. 2. A line, called the index stripe, of a material having high secondary emission compared to the aluminized background of the tube face, is placed behind every red line. A second beam, the "pilot" beam, parallel to the writing beam, is produced

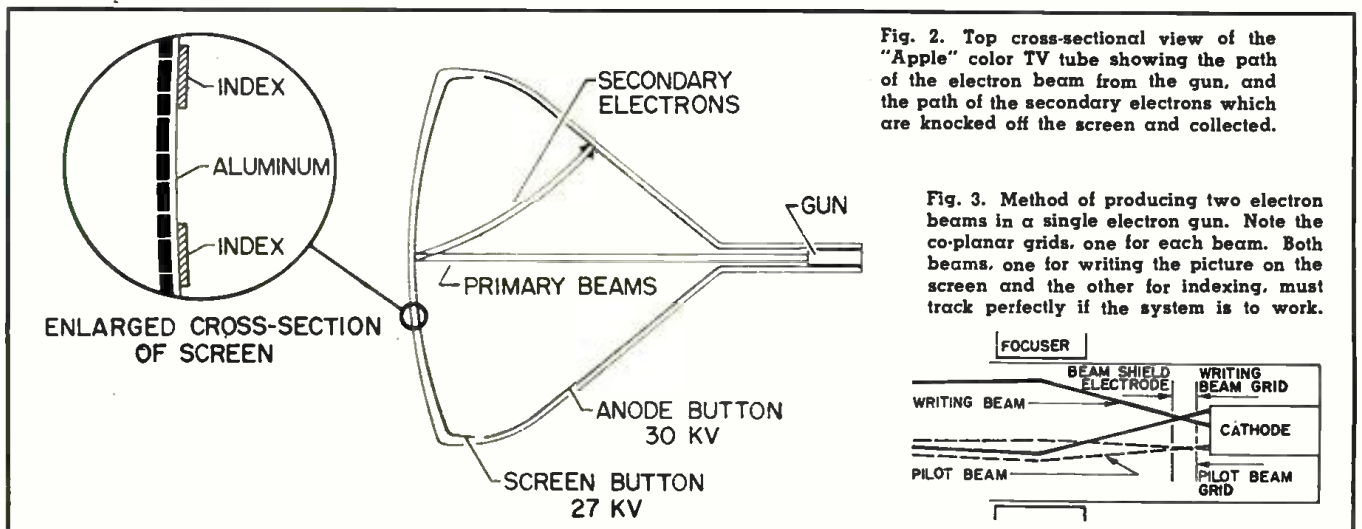
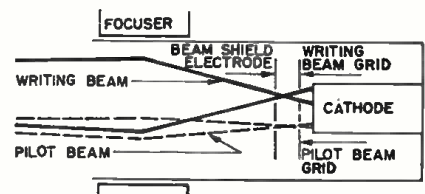

Fig. 2. Top cross-sectional view of the "Apple" color TV tube showing the path of the electron beam from the gun, and the path of the secondary electrons which are knocked off the screen and collected.

Fig. 3. Method of producing two electron beams in a single electron gun. Note the co-planar grids, one for each beam. Both beams, one for writing the picture on the screen and the other for indexing, must track perfectly if the system is to work.



at the gun and sweeps the index stripes in company with the writing beam. The secondary emission current produced as the "pilot" beam crosses these index stripes is collected and amplified, resulting finally in a signal at the same frequency as that at which the writing beam must be varied to produce colors.

The "pilot" beam is so aligned that it always strikes the same color line as the picture writing beam. However, the beams must be kept separate to avoid intermodulation between the "pilot" carrier and writing frequency signal.

The luminescent screen or anode of the "Apple" tube consists of a repeating array of red, blue, and green vertical stripes as mentioned previously. The stripes are not contiguous but have a 50% duty cycle; that is, the spaces between the lines are as wide as the phosphor lines themselves. The spaces between the lines are filled in with guard bands made of a dark-colored, non-luminescent material which improves color saturation and enhances contrast under normal ambient light by reducing the reflectivity of the screen. Correct white balance is built into the screen of the "Apple" tube by adjusting the relative efficiencies of the blue and green phosphors through the addition of varying amounts of non-activated material so that scanning of the screen with a constant, unmodulated beam produces white.

Among the important advantages of the "Apple" tube is its similarity to a black-and-white tube. In fact, in the absence of a chrominance signal, it cannot help making a good black-and-white picture. None of the writing beam in the "Apple" tube is intercepted nor deflected in such a way as to waste any high voltage power, and there is no problem of matching the characteristics of three guns to obtain good colorimetry.

The color saturation obtainable at any particular brightness level is obviously limited by the spot size at the beam current associated with that brightness. If the spot is too large to land on one primary color stripe at a time, then de-saturation of primary colors occurs. This consideration, plus that of reasonable structural resolution, made the development of an electron gun producing a spot substantially smaller than usual in a monochrome tube, a prime necessity for this beam-indexing tube.

A combination of a small, countersunk aperture and close cathode-to-grid spacing is primarily responsible for obtaining a greatly reduced spot size.

A second requirement is that the two beams "track" each other. Since one beam is used to tell where the other beam is, the relative position of the beams must be known at all times. The two beams are formed close together by using a single cathode, and two separate, co-planer, control grids, each with its aperture close to the end of the grid, these ends being separated by .002 inch. The center-to-center separation of the two beams at the grid plane is only .029 inch. See Fig. 3. This setup assures good "tracking," since both beams are so close together that they will be acted upon in exactly the same amount by deflecting fields, etc.

The third special requirement of this beam-indexing tube arises from the need for preventing the control voltage of one beam from affecting the intensity or position of the other beam. This is satisfied by using a simple shield between the two beams in the region just above the grid apertures. This shield, shown in Fig. 3, effectively eliminates beam "crosstalk" as a limitation on the functioning of the system.

The final unique feature of the *Philco* beam-indexing color tube is the index structure which provides the required continuous monitoring signal. This signal is generated by the difference in secondary emission between an array of magnesium oxide stripes applied to the gun side of the aluminized screen and the bare aluminum between these stripes. There are two contact buttons on one side of the tube envelope (see Fig. 5), and one of these is connected to the screen aluminum coating, making it possible to maintain the screen potential at approximately 27 kilovolts. The second contact button connects to the bulb coating which is maintained at 30 kilovolts. The three kilovolt differential between screen and bulb coating re-

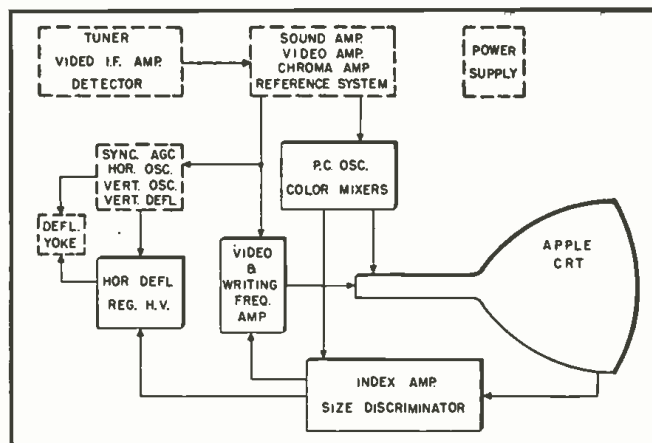

Fig. 4. Block diagram of developmental color TV set using single-gun color tube described in this article. The circuits enclosed in the solid boxes are peculiar to the "Apple" system.

sults in the collection of the secondary electrons from the screen by the bulb coating.

To obtain the indexing signal, an external band of a conductive coating encircles the screen viewing area to form a coupling to the screen aluminum film. A metal mounting band is strapped over this coating and is used to support the tube and yoke-focuser cup in a manner similar to monochrome receiver practice. The mounting feet, which support the assembly in the cabinet, are insulated from the metal mounting band but are grounded to the foil shield. The circuit elements formed by the band, the aluminized screen to which it is coupled, and ground, are tuned to resonance at the index sideband frequency. Index signal take-off is accomplished by a coaxial lead connected to the mounting band. To shield the index circuit from external interference, an aluminum foil shield is folded to cover the rim of the CRT. The tube and circuitry do not appear sufficiently sensitive to magnetic fields to require any magnetic shielding or compensation for earth field effects.

Fig. 4 is a block diagram of the circuitry of the receiver shown in Fig. 5. This is one version of a complete "Apple" receiver. The circuits shown in the light dashed lines follow conventional color receiver practice and the "Apple" receiver imposes no special requirements here. The re-

(Continued on page 115)

Fig. 5. Inside view of Philco developmental color TV receiver based upon beam-indexing principle and using "Apple" tube.

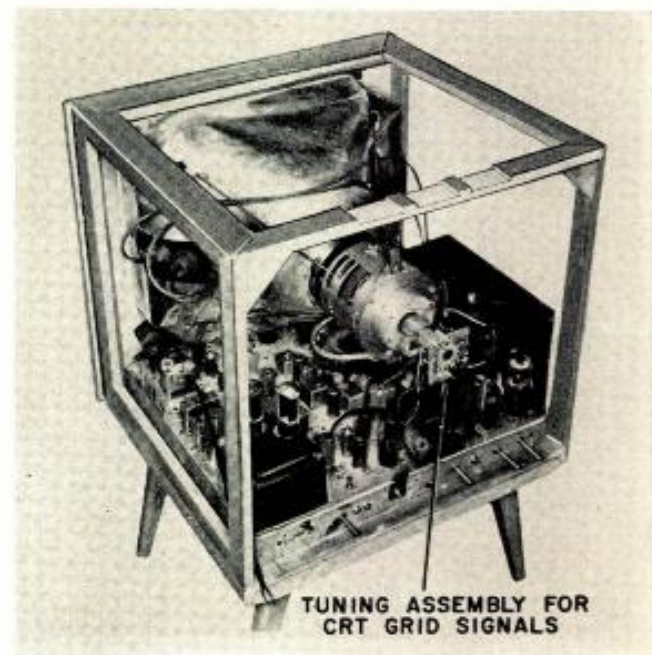

# A 20-Watt Amplifier System

A preamp and power amplifier with six inputs, tone controls, and loudness control—all on a single chassis.

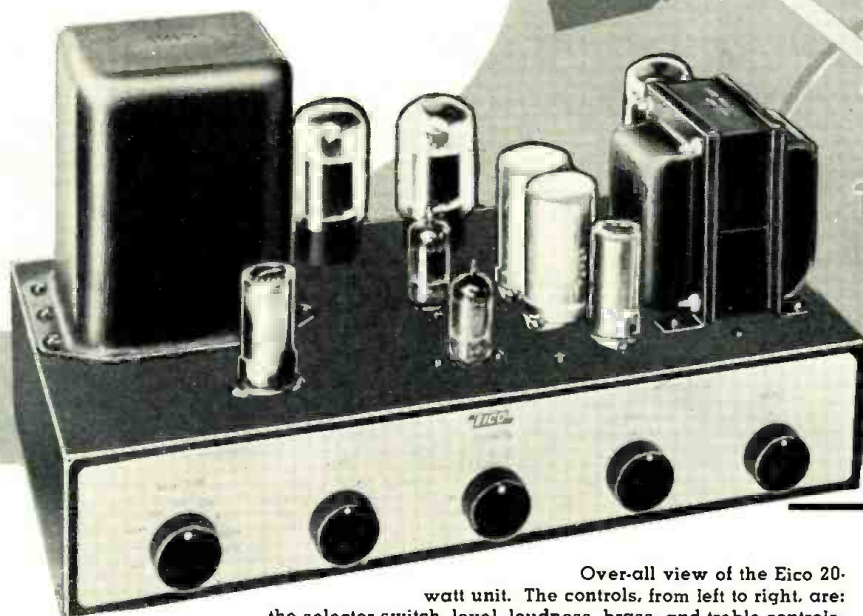

Over-all view of the Eico 20-watt unit. The controls, from left to right, are: the selector switch, level, loudness, bass, and treble controls.

FOR those who have been looking for a well-engineered yet inexpensive power amplifier, the newly-released Eico Model HF20 unit might offer a simple solution to their problem. Not only does this unit provide 20 watts of power but the circuit incorporates a preamplifier and a variety of controls on a single chassis.

Of the "Ultra-Linear" Williamson type, this compact (8½" high, 15" wide, and 10" deep) circuit provides up to 34 watts peak power. Frequency response is +0, -1 db from 13 to 35,000 cps at ¼ watt with power response at 20 watts +0, -1 db from 20 to 20,000 cps.

The circuit incorporates four high-level inputs and two low-level inputs. The high-level inputs will handle a TV set, tape recorder, AM-FM tuner, crystal and ceramic cartridges, or other equipment. The low-level inputs handle ceramic cartridges (with adapters) or FM and magnetic pickups, without component changes. A low-impedance output jack is conveniently placed for the accommodation of those owning or planning to buy a tape recorder.

There are five phono equalizer positions which can be selected by means of a rotary switch: RIAA, Columbia, London, European 78's, and American 78's. Bass can be boosted or cut 15 db at 50 cps, while the treble can be boosted or cut 15 db at 10 kc. Two separate controls provide this feature. These bass and treble tone controls are of the new feedback type for exceptionally low distortion and wide frequency range. They do not affect the volume or interact with each other, thus providing the easiest pos-

sible control settings. Since the turnover on both ends varies with the amount of boost and attenuation, boost or cut at the extremes of the audio range is possible without affecting the mid-range.

The loudness control circuit is a Centralab "Compentrol" which raises and lowers the volume in strict accordance with the Fletcher-Munson response curves.

The IM distortion of the amplifier

Equivalent sine wave power plotted against the percent of intermodulation distortion for the Eico 20-watt power amplifier.

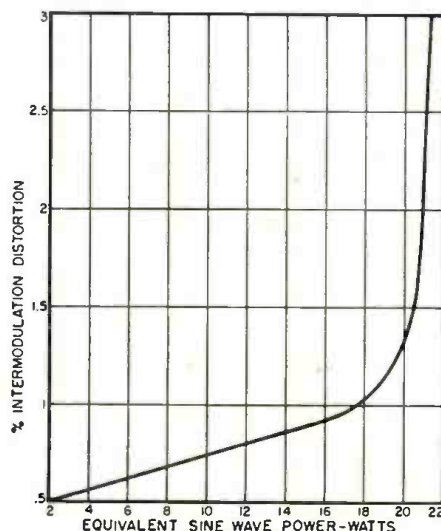

(60 to 6000 cps mixed 4:1 at 20 watts) is 1.3% while the mid-band harmonic distortion at 20 watts is .3%. The damping factor is 7:1 and the inverse feedback 14 db. Taps are provided for 4, 8, and 16 ohm speakers.

Sensitivity is .004 volt r.m.s. (at 1000 cycles) for 20-watt output with magnetic phono pickups and .4 volt r.m.s. for 20-watt output with the tuner and other accessory units.

Hum and noise is -60 db below 20 watts with magnetic pickups (including the 16 db boost at 60 cps due to RIAA compensation) and -75 db below 20 watts with the tuner, etc. Both of these figures were obtained with maximum gain and the tone controls set at the "flat" positions.

The HF20 will operate at either 50 or 60 cycles and voltages from 105 to 125 volts. The unit draws 100 watts.

The amplifier uses seven tubes: two 12AX7's, two 12AU7A's, one 5U4GB, and a pair of 6L6GB's in push-pull. If desired the output tubes can be replaced by 6L6GA's or the metal 6L6's or, if the builder chooses, the premium 5881's can be used. No circuit changes are required with these tube substitutions but the tubes must be matched to insure minimum distortion.

## Circuit Description

The circuit employed in the HF20 is fairly straightforward and conventional in design. The two low-level phono inputs are applied to a 12AX7



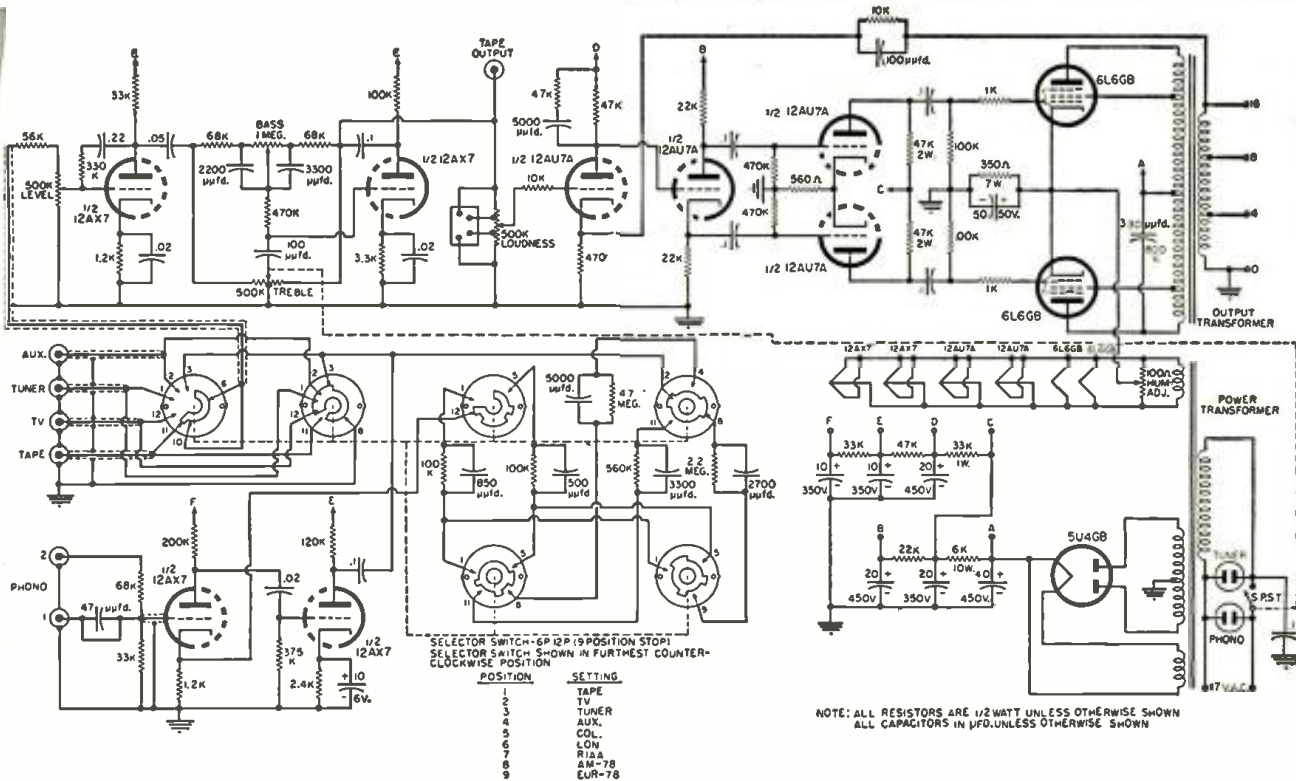

Complete schematic for the 20-watt amplifier, preamp, tone-control unit. The "system" is available commercially in kit or assembled form.

equalizer-preamplifier whose response characteristics are determined by the setting of the selector switch. Note that a jumper is wired across the  $47 \mu\text{fd.}$  input coupling capacitor from phono terminal 1. This jumper is clipped open when it is desired to use a *Weathers* FM capacitance pickup without the *Weathers* adapter. With such an adapter, this pickup is connected to terminal 2 and the jumper is left intact. Note also that the selector switch not only determines the equalization but also connects the proper input terminal to the unit. Output from the equalizer circuit or directly from the four high-impedance inputs is then applied through the level control to a second 12AX7 pre-amplifier circuit incorporating bass and treble controls. The output of this stage is then fed through the loudness control to a 12AU7A, operating as direct-coupled, low-level voltage amplifiers. The second section of this tube is a phase-splitter which feeds equal amplitude but opposite polarity signal voltages to another 12AU7A, the driver amplifier. Outputs from this driver are then applied to the grids of the 6L6GB push-pull power amplifiers whose screen grids are connected to taps on the output transformer to provide "Ultra-Linear" operation. Degenerative feedback is taken from the secondary winding of the output transformer and is applied to the cathode of the first section of the 12AU7 low-level voltage amplifier.

The HF20 is being offered in two forms, as a kit at \$49.95 and completely wired at \$79.95.

Harmonic distortion at 1000 cps versus the power output of amplifier (in watts).



Over-all frequency response of the amplifier at 1 and 20 watt levels from 10 cps out to 100,000 cps. The details on this response pattern are given in article.

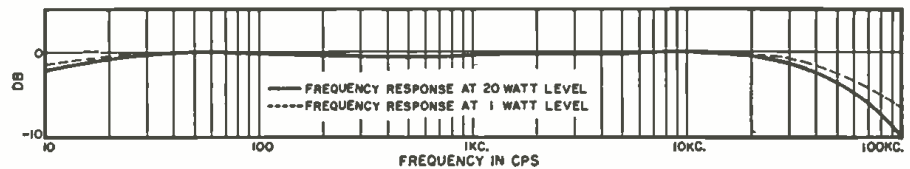

The available power of the amplifier before the clipping action and the over-all power of the unit at one per-cent harmonic distortion.

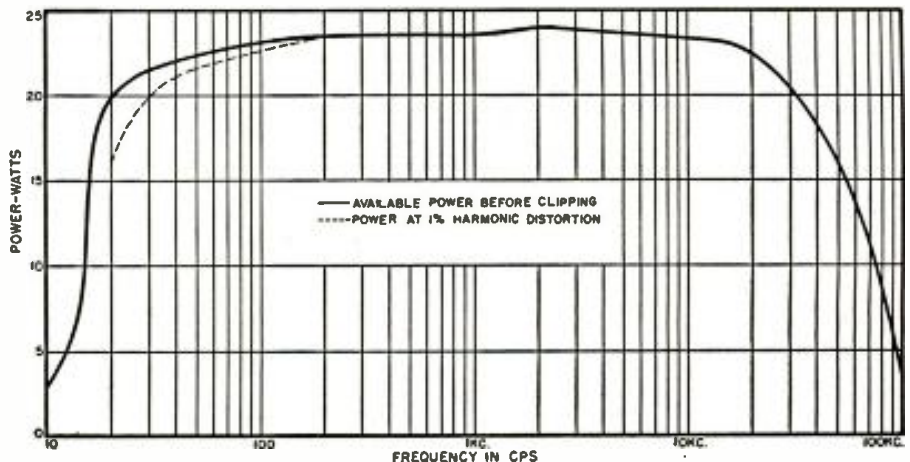

By SOL HELLER and PETER ORNE

# Keep Your Scope Operating

*Many scope defects can be found and repaired by the owner himself; here are some practical suggestions.*

**T**HE oscilloscope is the electronic right arm of the modern TV technician. If it is sent to the factory when it goes bad, the technician is likely to be separated from an important service tool for several weeks. To keep those waveforms cycling without interruption, it is desirable to repair the scope immediately when it becomes defective. This article will provide enough information to enable the technician to make such "on the spot" repairs.

An understanding of the basic construction of the oscilloscope, and the functions of its different sections, is necessary if repairs are to be made efficiently. Such an understanding can be obtained by considering the similarities—and differences—between a scope and a TV set.

Both instruments are built around a CRT. The most important function of the TV set is to display the necessary variations in brightness on the CRT screen in conjunction with the proper sweep; the scope's most important function is vertical deflection. In the TV set, the wide-band amplifier is the video amplifier; in the scope, it is the vertical amplifier. In both instruments, high voltage is required to accelerate the CRT beam. The scope does not require as much high voltage as the TV receiver for two reasons:

1. The beam in the scope CRT does not have to move as quickly and

therefore does not have to be as intense as the beam in the TV receiver CRT. The TV receiver beam covers the entire screen in 1/30 of a second; the beam in the scope, on the other hand, traces one waveform or series of waveforms continuously. The illumination of the scope screen is adequate with a lower amount of high voltage present.

2. A hood can be used over the scope CRT to shield it from outside

light. The screen illumination and high voltage requirements are reduced to some extent for this reason.

The size of the scanning spot on the scope CRT is larger than it is on a TV receiver CRT due to the smaller amount of high voltage used in the scope; a larger spot is, however, tolerable in the scope.

In the TV set, the video signal is applied between the CRT grid and cathode. These electrodes are generally kept near ground potential. In the scope, the signal is fed to the vertical deflection plates, and sometimes also to the horizontal deflecting plates. These scope electrodes will therefore be found near ground potential. However, the 2nd anode of the scope CRT must be at the same potential as the deflection plates, to avoid the defocusing that would take place if this requirement were not met. This necessitates the application of a high negative voltage to the cathode of the scope CRT. (In the TV CRT, a high positive voltage is applied to the 2nd anode.) A still more negative voltage must be applied to the control grid of the scope CRT, to provide the proper bias.

A final important difference between a scope and a TV set is that the scope generally uses an electrostatically deflected CRT, while the TV receiver commonly uses a magnetically deflected one. The reason for this is that the yoke required for magnetic deflec-

Fig. 1. Block diagram of a typical service-type oscilloscope showing the basic sections only. Specialized scopes often have more elaborate circuitry.

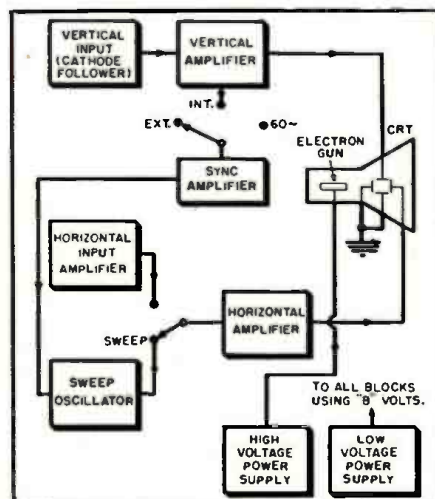

tion of a scope CRT would have to permit a current to flow that was proportional to the input signal, to produce a faithful replica of the input signal waveshape on the screen. This is rather difficult and expensive to achieve (scopes using magnetic deflection have, however, been built). In an electrostatic deflection system, no such problem exists; deflection plates are fed by sweep voltage amplifiers, and such amplifiers can readily be designed to reproduce the signal waveshape with adequate fidelity. The capacitance between each set of deflection plates distorts the signal waveshape to some extent, but the effect can readily be compensated.

The block diagram of a representative scope is shown in Fig. 1. The functions of the different sections should, by now, be self-evident to the technician. A representative oscilloscope circuit is reproduced in Fig. 2.

### Servicing Procedures

When power is applied to the scope, various controls are manipulated—chiefly brightness, focus, and centering—to obtain a visible scanning spot on the CRT screen. If no spot can be obtained, the fault may lie in one of the controls just referred to, the power supply, or the CRT. To locate the defect, proceed as follows:

Turn the brightness control all the way up and carefully examine the screen. If a faint glow is visible at the edge of the screen, centering trouble is present. The glow referred to is produced by stray electrons; such electrons are not affected by the centering voltages and will thus cause a glow to be visible even when these voltages are improper. If the glow is not visible, turn the brightness control from high to low setting and back. If a faint glow is present, varying its brightness will make it more discernible. If the procedure just outlined causes the glow to become visible but the scanning spot cannot be made to appear, look for trouble in the centering circuits.

In many scopes with push-pull vertical deflection, the output tubes are direct coupled to the CRT deflection plates; varying the bias of these tubes (by means of potentiometer adjustment) provides centering. If one of the push-pull amplifier tubes is defective, centering will not be possible. Look for a defect of this kind, when centering trouble is present in such a scope.

In some oscilloscopes, the output tubes are single-ended; that is, the vertical and horizontal amplifiers each feed one deflection plate, while the opposite plate is grounded. A potentiometer in the circuit associated with one deflection plate (of each pair) varies the d.c. voltage present between both plates, and thus permits centering adjustments (see Fig. 3). If centering is absent or improper in a scope of this kind, look for a defect in the centering potentiometers, or in some resistor in the voltage divider circuit

associated with each potentiometer.

If the service technician suspects that trouble exists in a centering circuit, but is uncertain whether this is actually the case, the following test will help him reach a decision:

Short the deflection plates to each other (horizontal to horizontal and vertical to vertical) at the terminals on the scope where provisions have been made for applying signals directly to the plates (see Figs. 4A, 4B, and 4C). (Most scopes have such provisions to permit a signal to be applied directly to the deflection plates, rather than through the scope amplifiers; the latter may distort certain types of signals.) If a spot can now be obtained, trouble in the centering circuits is definitely indicated.

If no scanning spot is seen on the CRT screen, and the centering system has been given a clean bill of health, the voltages at the CRT socket should be checked. Keep in mind that high voltages, negative with respect to ground, are present at the CRT socket. Treat this part of the scope with respect, since it is capable of dealing out dangerous shocks. The high voltage in an oscilloscope is derived from a half-wave rectifier circuit which is fed line voltage that has been stepped up by a transformer. This type of "brute force" supply is generally capable of delivering lethal currents, so be careful.

The voltages that may normally be expected at the CRT socket are as follows:

The cathode is generally about 2000

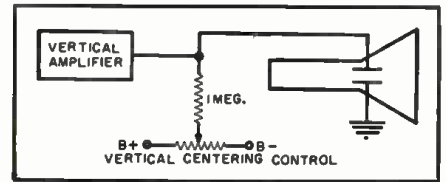

Fig. 3. Simplified schematic diagram of one type centering control circuit.

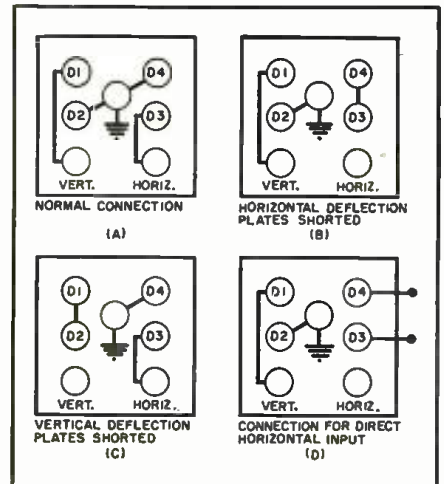
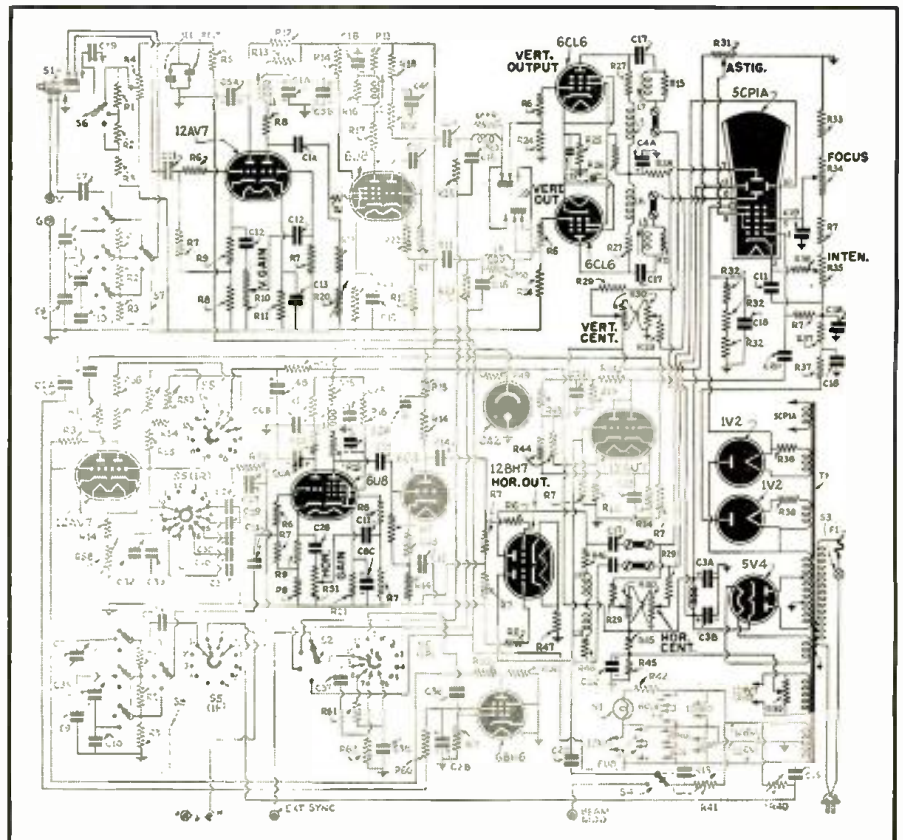

Fig. 4. Most oscilloscopes contain terminals at the rear or on the side for direct connection of an external signal to the deflection plates as shown.

volts negative with respect to ground. In some scopes, the cathode-to-ground voltage is less, and may even be as little as -700 volts. The control grid is normally between 0 and 80 volts

Fig. 2. Schematic diagram of a typical general-purpose oscilloscope using push-pull deflection. Note highlighted sections. This is the Precision ES-550.



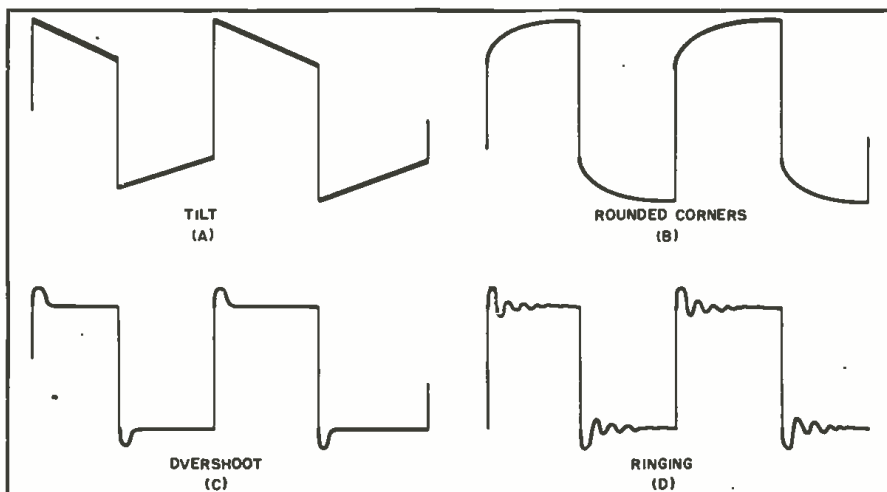

Fig. 5. Effect of a defective vertical amplifier on a square-wave signal fed into the scope from a square-wave generator. If the vertical amplifier has poor low-frequency response, the scope will reproduce the square wave as shown in (A); poor high-frequency response is shown in (B). (C) and (D) are the result of excessive high-frequency response of the oscilloscope's vertical amplifier.

negative with respect to the cathode, depending on the setting of the brightness control. The focus anode voltage varies from one scope to another. It should generally be one-fifth to one-third the value of the high voltage present in the scope.

An accelerating anode (in addition to the 2nd anode) is used in the scope CRT to speed up the beam. In less expensive scopes, this anode may be found connected to the 2nd anode, with both anodes grounded. Or, both

anodes may be connected to "B+" to provide a little more accelerating voltage. In other scopes, the accelerating anode voltage is made variable; the potentiometer used to vary it is called an "astigmatism" or "spot shape" control, since its adjustment affects the roundness and sharpness of the scanning spot. The "astigmatism" control generally permits a voltage varying from 0 to 200 volts to be applied to the accelerating anode.

Finally, there is the CRT heater

Table 1. Review of the testing procedure outlined in the text for troubleshooting defective oscilloscopes. Be certain to refer to the manufacturer's schematic.

SYMPTOM	TEST	NORMAL TEST RESULT	DEFECTIVE SECTION
Dead scope, pilot light off.			Power supply; fuse.
Pilot light on, no trace or light.	Turn brightness full up.	Glow on screen of CRT.	If there is no glow check the low or high voltage power supply or CRT. If there is a glow, see symptom. "No trace, glow present."
No trace, no glow.	CRT voltages.	2nd anode: 0 to "B+." Focus anode: -200 to -1000 v. Cathode: -700 to -2000 v. Grid-to-cathode: 0 to -80 v.	If the voltages are incorrect, check the power supply. If voltages are correct, check the CRT.
No trace, glow present.	Short the deflection plates.*	Spot on screen.	If there is no spot visible, check the CRT. If the spot appears, check the centering circuit.
Centered spot, no horizontal line.	Apply a.c. test signal to horizontal input.	Horizontal line.	If no line is present, check horizontal amplifier. If line appears check the horizontal sweep oscillator.
Horizontal line, no vertical deflection.	Apply a.c. test signal to points along vertical amplifier.	Sine wave.	Defective stage precedes point where sine wave first appears.

\*Horizontal to horizontal, vertical to vertical plate.  
Note: Voltages indicated in column 3 depend on particular scope under test.

voltage. This is standardized at 6.3 volts in all modern oscilloscope CRT tubes.

For proper operation of the scope, normal voltages must be present at the CRT. Use a suitable voltmeter, or voltmeter-probe combination, to measure the high voltage. Exercise due caution in making this measurement. If the CRT voltages are normal, and no scanning spot can be obtained, the CRT is defective. If the voltage between any electrode and ground is incorrect, the circuit components associated with that electrode should be checked. The electrodes connect to simple voltage dividers in the power supply; such circuits are relatively easy to troubleshoot. If no high voltage is present, the high-voltage rectifier or power transformer may be defective, or a filter capacitor may be bad.

### No Sweep

If a spot is seen on the CRT, but no horizontal sweep is obtainable, that is, a horizontal line cannot be produced on the screen by suitable manipulation of the scope controls, the trouble lies in the CRT, horizontal sweep oscillator, or horizontal sweep amplifier. The trouble can be further localized by switching off the scope horizontal oscillator (through suitable adjustment of one of the scope controls) and applying an a.c. test signal to the horizontal input terminals. Such a signal is generally available at the front panel of the scope. If a horizontal line of some kind now becomes visible, trouble in the horizontal sweep oscillator is indicated. If the test signal does not produce any visible output, the trouble probably lies in the horizontal amplifier. A defect in the CRT may also be responsible for the symptoms.

To determine which of these possible sources of trouble is present, apply a test signal directly to the CRT horizontal deflection plates (after first disconnecting the plates from the amplifier circuit, as indicated in Fig. 4D). If a horizontal line is now seen, the horizontal amplifier is defective; if there is no horizontal line, the trouble is in the CRT. It should be noted that in some scopes, the horizontal oscillator and amplifier are contained in the same tube; a defect in such a tube may make the horizontal sweep oscillator and amplifier stages simultaneously inoperative.

If a defect in the horizontal amplifier stage is indicated by the preceding test, try a new horizontal amplifier tube first. When several stages are present in the horizontal section, the scope itself may be used to locate the circuit point at which the signal is lost. One of the two procedures to be described may be employed for such troubleshooting (it is assumed that there is no horizontal sweep and tube replacement tests have not revealed the defect):

1. Feed a 60 cps test signal to the

(Continued on page 116)

only **LAFAYETTE** can do it! **SAVE 33 1/3-50%**

**PROFESSIONAL TRANSCRIPTION TURNTABLE AND VISCOUS-DAMPED TONE ARM**  
THE FINEST TRANSCRIPTION TURNTABLE AND TONE ARM FOR THE PROFESSIONAL USER AND THE AUDIOPHILE



**PK-90 COMBINATION DEAL**  
The above with G.E. RPK-0574 DIAMOND AND SAPPHIRE Cartridge  
**PK-100 TURNTABLE AND PK-90 TONE ARM 72.50**

**PK-100 TRANSCRIPTION TURNTABLE**  
New 3-speed instrument to delight the connoisseur, is precision engineered to provide dynamic balance and "wow-free" operation. A heavy-duty, constant speed 4-pole induction motor has a variable speed control to permit instant adjustment of the individual speeds to within  $\pm 7\%$  to compensate for power source voltage variations. The motor is freely suspended and isolated by shock-mountings to eliminate vibration transfer. The heavy, cast aluminum turntable is rim-driven and has an extra-heavy rim for smooth, effective flywheel action. Idler disengaged in "off" position. Meets professional standards for wow, flutter content, etc. Size: 13 1/2" x 14" and requires 2 3/4" clearance above and 3 3/4" below motorboard. For 110-130V 60/50 cycle AC. Supplied with removable 3-speed stroboscopic disc and 45 rpm adapter. Handsome hammertone gray finish. Shpg. wt., 20 lbs.  
**PK-100**.....Net 49.50

**PK-90 VISCOUS-DAMPED TONE ARM**  
This transcription arm assures dependable and stable operation, utilizing the "floating action" principle of "viscous-damping." The arm is supported at a single point by a pivot and jewel bearing having negligible friction. Damping is accomplished by a silicone fluid occupying the gap between a ball and socket. This damping control permits high compliance and negligible tracking error, and prevents damage to either record or stylus should the tone arm be accidentally dropped. Low frequency resonance, skidding and groove-jumping are likewise minimized. The tone arm accepts all records up to 16" and accommodates virtually all hi-fi cartridges by means of precisely engineered adapters which simplify installation and provide proper stylus pressure. This tone arm is a quality companion to the PK-100 with matching finish. Shpg. wt., 2 1/2 lbs.  
**PK-90**.....Net 19.50

**FM-AM TUNER KIT**

- AFC DEFEAT CIRCUIT WITH FRONT PANEL CONTROL
- FOSTER-SEELEY DISCRIMINATOR CIRCUIT
- GROUNDED GRID TRIODE AMPLIFIER
- 20-20,000 CPS RESPONSE

Choose this 7 tube compact high-fidelity FM-AM tuner whose characteristic features are found in units costing many times as much, and whose performance is unheard of at this low price. There are two front panel controls, a function control for AM, FM, PHONO, TV and a tuning/AFC defeat control. Features Armstrong FM circuit with limiter and Foster-Seeley discriminator. Simplified tuning with slide-rule dial and fly-wheel counterweighted mechanism, high impedance phono input and high impedance audio output.

**SPECIFICATIONS**  
FREQUENCY RANGE: FM, 88-108MC. AM, 530-1650 KC. ANTENNA INPUT: FM, 300 ohms. AM Ferrite loopstick and high impedance external antenna. **DISTORTION:** Less than 1% at rated output. **FREQUENCY RESPONSE:** FM,  $\pm 5$  db 20 to 20,000 cps, AM  $\pm 3$  db 20 to 5000 cps.

**Basic FM-AM Tuner having outstanding specifications and delivering astonishing performance — all at a budget price in easily assembled kit form.**

**SENSITIVITY:** FM, 5 UV for 30 db quieting, AM, Loop sensitivity 80 UV/meter. **SELECTIVITY:** FM, 200 KC bandwidth, 6 db down; 375 KC FM discriminator peak to peak separation, AM, 8 KC bandwidth, 6 db down. **IMAGE REJECTION:** 30 db minimum. **HUM LEVEL:** 60 db below 100% modulation. **TUBE COMPLEMENT:** 2-12AT7, 1-6BE6, 1-6BA6, 2-6AU6, 1-6AV6, 1-6X4, 1-6X5 selenium rectifier. **SIZE:** 5 1/4" high x 9 3/4" wide x 9 3/4" deep (excluding knobs). **CONSUMPTION:** 30 watts. For 110-120V 60 cycles AC. Attractive etched copper-plated and lacquered finish. Less metal case. Shpg. wt., 9 lbs.  
**KT-100**.....NET 32.50

**ML-100**...Metal cage for above, Shpg. wt., 3 lbs. .... 5.00

**LAFAYETTE SIGNAL GENERATOR**

NEVER BEFORE HAS A COMPLETELY WIRED AND TESTED INSTRUMENT OF SUCH ACCURACY AND QUALITY BEEN OFFERED AT SUCH A PRICE!

- FREQUENCY 120 KC TO 250 MC
- 120 KC TO 130 MC ON FUNDAMENTALS
- LABORATORY ACCURACY AND QUALITY

A completely wired and tested instrument not to be confused with units sold in kit form at almost the same price, but with a quality and accuracy of instruments 3 to 4 times its price. Six overlapping ranges generate signals of 120KC — 320KC, 320KC — 1000KC, 1MC — 3.2MC, 11MC, 11MC — 38MC and 37MC — 130MC all on fundamentals with calibrated harmonics from 120MC to 260MC. Selector switch gives instant choice of ranges. Switch gives choice of internal modulation of 400 CPS or use of any external source at other frequencies. For audio testing the 400 cycle signal can be used separately. Outputs are unmodulated RF, modulated RF and 400 CPS audio. RF output is in excess of 100,000 microvolts and jacks are provided for choice of either high or low RF output. Stability is insured by special circuit design. Has a fine adjustment RF control. AF output is 2-3 volts, AF input is 4 volts across 1 megohm. Large clear 5 inch etched dial plate and pointer are protected by transparent plastic bezel. Common AF terminals for EXT-MOD input and INT-AF for audio tests eliminate need for special AF output connectors. Machine engraved panel lettering. Handsome gray metal case with carrying handle. Measures 6 1/2" x 10" x 4 1/2". Comes complete with pair of leads, AC line cord and plug. Operates on 105-125V 50-60 cycle AC. Shpg. wt., 8 lbs.  
**LAFAYETTE LSG-10 SIGNAL GENERATOR**..... 22.50

**SLIM HIGH OUTPUT DYNAMIC MICROPHONE**

Reg. Price ~~47.50~~

**NEW!**

A pencil-slim design, high output PA Dynamic Microphone of exceptional quality, at a price that is 1/2 of the price of any comparable microphone on the market today. Very smooth response, 60-10,000 cycles. Omnidirectional, tiltable head. Switch on side gives choice of either high impedance (50,000 ohms) or low impedance (250 ohms). Instantly removable bracket permits use either on stand or as hand mike. Features exceptional mechanical strength. Cast case with satin chrome finish. 3/8" -27 thread. Acoustically-treated grille head, 8" long; 1 1/4" barrel diameter. Shipping weight 2 lbs.  
**PA-29**..... In lots of 3, Each 9.25  
Singly, Each 9.95

**R/C RECEIVER AND TRANSMITTER**  
RANGE OF APPROXIMATELY 1 MILE

**R/C TRANSMITTER**      **R/C ESCAPEMENT**

**R/C RECEIVER**

**R/C Receiver** is completely assembled and wired, with tube and ready to operate on exam-free 27.255 MC remote control band. Size: 1 3/8" x 1-15/16" x 3". Wt. 3.3 oz. Requires one 1.5 volt and one 45 volt battery.  
**F-208**..... Net 7.95

**R/C Transmitter** is completely assembled, tested and guaranteed, and includes tube and 27.255 MC crystal, 6 section telescoping antenna. Size: 4" x 4" x 12". Less batteries. Shpg. wt. 3 lbs.  
**F-249**..... Net 19.95

**TRANSMITTER** 1 Burgess, 2D or RCA VS069 Net. Ea. .45  
**BATTERIES:** 2 Burgess XX45 or RCA VS016.....Net. Ea. 2.28

**R/C Escapement** is completely wired, sturdy and self-neutralizing. Weighs 1/2 oz. Low current drain. Size: 1 3/8" L x 1 1/2" W. Shpg. wt. 5 oz.  
**F-194**..... Net 2.45

**SPECIAL COMBINATION OFFER**  
Consists of R/C Transmitter (F-249), R/C Receiver (F-208) and Escapement (F-194). All three at a super special price.  
**F-250**..... Net 28.95

**LAFAYETTE GEIGER COUNTER KIT WITH HIGH SENSITIVITY VICTOREEN TUBE 1B85**

Lafayette Geiger Counter Kit with High Sensitivity Victoreen 1B85 tube, makes this one of the most outstanding kit buys in the country. This tube is used only in the most expensive equipment. Easy to build, at only a fraction of the price of commercial instruments of this type. Just turn it on, flip the high voltage switch and listen to the clicks. Kit includes all parts, tube, carrying case, 22 1/2" and 1 1/2" volt Batteries. Complete instructions for quick assembly. Shpg. wt., 1 1/2 lbs.  
**KT-75**.....Net 14.95

**IMPORTED 12 HI-FI COAX. SPEAKER**

Reg. Price ~~44.50~~  
**Net 29.50**

- FREQUENCY RANGE 30-15000 CPS
- HANDLES 20 WATTS OF POWER
- COMPLETE WITH LEVEL CONTROL
- POWERFUL TSK-5 MAGNETS
- SPECIAL SHEEPSKIN-EDGED CONE

A Lafayette exclusive import and exceptional value. Consists of a 12" woofer, coaxially mounted 2 1/2" tweeter and a built-in crossover network. The specially processed fibre cone has a sheepskin edge to suppress unwanted nodal vibrations and insure beautiful tone quality. Highly efficient TSK-5 magnets. Level control provides variation to 6 db cut-off. Maximum input 20 watts. Impedance 8 ohms. Rugged all-metal frame. If made in this country, would cost at least \$49.50. Shpg. wt., 11 lbs.  
**SK-58**.....Net 29.50

**CRYSTAL MICROPHONE**

COMPARE IT WITH ANY MIKE AT 2 TO 3 TIMES THE PRICE

A quality crystal microphone for PA systems, house recorders etc. Frequency response 30 to 10,000 cycles. Output level —52 db. Provides ample output for use with low gain amplifiers. Complete with 5 ft. of shielded cable. Shpg. wt., 3 1/2".  
**PA-24**— In lots of 3, each .. 3.95  
singly, each ..... 4.25

**IMPORTED BINOCULARS**

All have coated lenses — clamped in prism — light weight all metal bodies. Complete with case and straps.

F-102	6x.15 I.P.	NET 10.75
F-105	8x.30 I.P.	NET 14.95
F-15	7x.35 I.P.	NET 17.95
F-103	7x.35 C.P.	NET 20.95
F-103	7x.50 I.P.	NET 21.50
F-104	7x.50 C.P.	NET 24.95
F-117	10x.35 C.P.	NET 23.95
F-118	12x.50 I.P.	NET 17.95
F-118	15x.60 C.P.	NET 31.50
F-185	20x.50 C.P.	NET 37.50

Add 10% Fed. Tax to Above Prices

**REMOTE CONTROL FOR SILENT TV VIEWING**

• For Hard-of-Hearing  
• For Late Listening

One or two people can both see or hear the program with the loud speaker cut-off. The hard-of-hearing can listen to radio or TV without turning the volume so high that others can't stand the noise. Comes complete with miniature phone and 20' of cable. Shpg. wt. 3 lbs.  
**MS-125**.....Net 6.50

**Lafayette Radio** DEPT. RG  
BROOKLYN, N.Y. 542 E. 14th St.  
NEWARK, N.J. 24 Central Ave.  
PLAINFIELD, N.J. 139 West 2nd St.  
NEW YORK, N.Y. 110 Federal St.  
BOSTON, MASS. 110 Federal St.

Send FREE 132-Page Lafayette Catalog

Name \_\_\_\_\_  
Address \_\_\_\_\_  
City \_\_\_\_\_ Zone \_\_\_\_\_ State \_\_\_\_\_

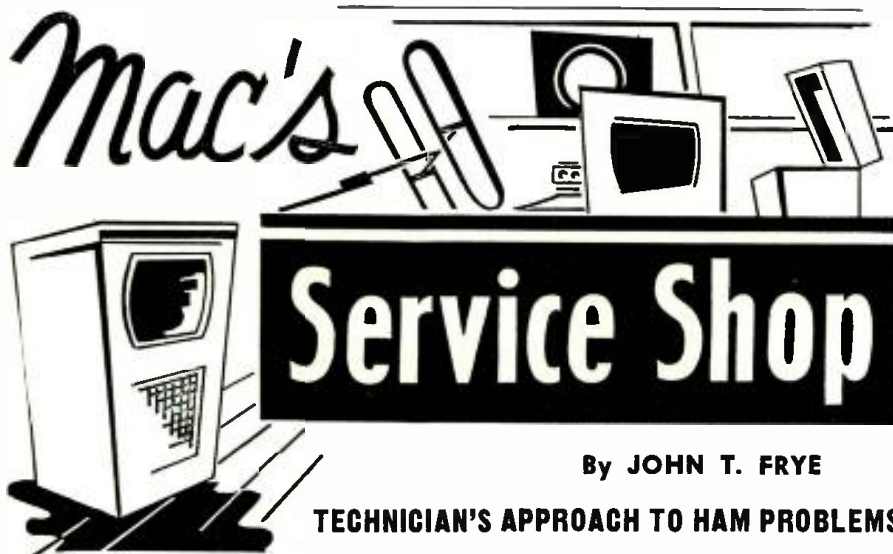

By JOHN T. FRYE

## TECHNICIAN'S APPROACH TO HAM PROBLEMS

IT WAS a blistering hot July day outside, but the interior of Mac's Service Shop was a cool and dry seventy-five degrees, thanks to the new air conditioning units that had just been installed in both the front office and the service department.

"You know, Mac, it's a real joy to return to work here on a hot day like this," Barney remarked. "I could hardly wait to get back after lunch. That sun's a real scorcher today."

"I'm glad to hear you say that," Mac, his employer, replied. "I've been noticing how prompt you are recently, and I'm beginning to hope the extra work I'll get out of you may help pay for the air conditioning."

"I know this installation set you back plenty, but in my book it's worth it," Barney said earnestly.

"In all seriousness, I'm sure it is," Mac agreed. "First, it creates a favorable impression on the customers who come into the shop. Secondly, Amanda is patient and courteous with them because she is comfortable and at ease; and you and I do much better work, too, because we are comfortable. When sweat is running down your arms and dripping off the end of your nose into the chassis on which you are working, it is dogged hard to be alert for every symptom of something not quite right. There is every temptation to let things slide a bit and to finish off the job as quickly as possible. That's just human nature."

"You're so right. I was wishing last night that our radio club meeting was air conditioned. I had to give a talk; and between nervousness and the sticky weather, I was sweating like a hoe handle."

"What did you talk about?"

"The title was 'A Professional Technician's Approach to Ham Problems.' In case you're wondering, I am the professional technician—and please keep any remarks about same to yourself."

"I have no remarks," Mac denied blandly. "You are a professional technician, and a darned good one. To admit otherwise would be to impugn my ability as a teacher—and we can't have that, can we?"

"I'll have to think that over a bit before I can decide whether I've been complimented or insulted. At any rate, I feel I'm well prepared to talk on this subject because I've worked both sides of the street. I can well remember the blundering hit-and-miss methods I used to employ in trying to run down trouble in my ham equipment, and I also know how comparatively easy it is for me to locate and straighten out these difficulties now. Yet practically the whole difference lies in how I went at the job before and how I tackle it after doing TV service work for a few years."

"Sounds interesting," Mac remarked. "Tell me more."

"Remember you asked for it," Barney warned with a pleased grin. "I started out by saying any technician worth his salt realized he had to have a certain minimum amount of service equipment to do a good job. At the same time I well understand from my own experience that the average ham has only a limited amount of money to spend on his hobby and he prefers to allot all he can to improving the 'productive' ether-busting quality of his signal rather than investing in 'non-productive' test equipment."

"That figures."

"Then I went on to say I thought the best investment for a ham was a 20,000 ohms-per-volt v.o.m. If he likes, he can select one of several excellent instruments of this kind on the market; or, if he prefers, he can buy one in kit form and put it together himself."

"Why not a v.t.v.m.?"

"I was hoping you'd ask that," Barney said complacently. "There are several good reasons. First, a v.t.v.m. is likely to be affected by the strong r.f. fields around a transmitter and give erratic unreliable readings when the rig is on. Secondly, the v.o.m. is self-contained and independent of the power lines. It can be used just as easily for checking the mobile rig in the trunk of the car as for use with the transmitter in the shack. Finally, most v.t.v.m.'s do not have provision for reading currents; and being able to read currents accurately is quite important around a transmitter."

"You overlooked one more argument: generally speaking a v.o.m. retains its calibration better than does a v.t.v.m. because of the different principles on which the two operate. This becomes important when a person has only one general-purpose meter and must depend upon what it tells him without being able to check it easily against other meters. The ham who has a good v.o.m. in his shack and takes care of it will have a standard on which he can depend year after year."

"That is a good point, and I should have thought of it. Your saying something about 'taking care of the meter' reminds me I brought that up, too. I passed along that little trick you taught me of always automatically returning the meter selector switch to the '1000 volts d.c.' position as soon as I finished making a measurement. That way, if you forget to reset the switch to the proper scale before socking the test prods across high voltage—and this is so easy to do—no damage will be done."

"I went on to say that it was a good idea when making checks on a transmitter always to check first with the meter in the 1000 volts d.c. position before setting the function-scale switch to a scale you think should be adequate. Things can happen in a rig that will produce unusual voltages at unexpected places. If you happen to try to check the resistance at one of these points, the meter pointer will probably end up looking like a hair spring. Testing for any possible voltage before going to the 'ohms' scale will obviously prevent this disaster."

"What else did you tell the boys?"

"I talked about how important it was to have an accurate and up-to-date diagram of the equipment around the ham shack. I explained that we had around five hundred dollars tied up in nothing but diagrams of the receivers on which we worked and that we were adding to this constantly, for we know how much easier it is to troubleshoot with a diagram. I urged that diagrams of the receivers, transmitters, and test equipment all be kept conveniently together. If the transmitter is home-brew, a very careful diagram should be drawn up. Whenever any change is made in any of the equipment, that change should be carefully and immediately noted on the diagram."

"That certainly makes a lot of sense."

"Next I told how much better it is to use 'dynamic' testing methods rather than the 'static' kind. I explained that we always try to put a receiver into some kind of operating condition as soon as possible because it is much easier to spot trouble in a live set than in one not turned on. In the latter case, all you can do is check each component separately until you finally stumble on one that is bad—if you're lucky enough to have trouble that will reveal itself in this kind of test. On the other hand, with the equipment working, a defective part will usually produce several symptoms, such as changes in voltage or current, overheating of parts, oscil-

lation, etc., that will point accusing fingers right at the defective unit. Dynamic testing is particularly effective and easy with transmitters because the signal handled is of robust, easily-measured proportions. A crystal r.f. probe used with the v.o.m. will detect the presence of r.f. at low intensity points, such as grids; and the old reliable, cheaply-built absorption type wavemeter will show the presence and frequency of this r.f. in the plate tank circuits.

"This, of course, led directly into the subject of dummy antennas. I said flatly that in my book a dummy antenna was the first piece of test equipment any ham ought to build, since he could do this easily by selecting the proper number and wattage of incandescent lamps and connecting them in series, parallel, or series-parallel arrangement to present the proper impedance load to the transmitter while absorbing its normal output. Using such a device a ham can troubleshoot his transmitter to his heart's content without disturbing fellow amateurs. A defective transmitter has no more place on the crowded ham bands today than a defective automobile has on our crowded highways."

"That's advice apparently some of them could use. I still hear fellows on the air with lousy signals asking others to diagnose their trouble and tell them how to fix it."

"I know, and that's about as sensible as going around asking your neighbors for medical advice when you're sick. Anyone who has listened even casually to one of these 'round-table clinics' quickly decides that what one ham terms a good signal another calls terrible. Each one, since he has no reliable observed data to go on, comes up with a different suggestion based on his own narrow experience. Nine times out of ten, trying to find your trouble that way is just a waste of time and a nuisance."

"How did you wind the talk up?"

"I tried to explain that troubleshooting is composed of roughly these steps: First, you gather all the symptoms you can from observation, voltage and current checks, listening on the monitor, and so on. Then, keeping all these symptoms in mind, you study the diagram and try to imagine a component failure that could produce all the symptoms. Having decided on such a component, you test it individually or replace it with a unit known to be good and see if that clears up the trouble. If not, you replace the original part and look for another likely suspect. It is important that you change only one part at a time so that when and if you do cure the trouble you will know what was causing it. Changing parts in a helter-skelter manner may easily contribute new troubles to those with which you started.

"As a finale I gave an example of what I meant. Suppose I receive a report my modulation is distorted. Immediately I pull the transmitter off

(Continued on page 129)

... another  
**MALLORY**  
service-engineered  
product



## New Mallory "Gems" pace setters in paper capacitors

Next time you replace paper tubulars, make sure you use these new Mallory capacitors. They give you a lot of extra value features—without extra cost.

**Soldering iron heat can't loosen leads.** Wires are permanently attached in the plastic end seal... can't work loose from heating or vibration.

**Moistureproof construction,** using a protective case of high grade mica-filled bakelite, ends worries about premature shorts due to high humidity.

**True center construction** protects the foil element from deformation during assembly... assures uniform quality in each capacitor.

Get your stock now, from your local Mallory distributor. Ask for Mallory "Gems"—you'll agree they're a gem of a capacitor!

P. R. MALLORY & CO. Inc.  
**MALLORY**

P. R. MALLORY & CO. Inc., INDIANAPOLIS 6, INDIANA

- Capacitors
- Vibrators
- Resistors
- Power Supplies
- Controls
- Switches
- Rectifiers
- Filters
- Mercury Batteries

# HEATHKIT®

... world's finest  
electronic equipment  
in kit form



A MODEL O-10



B MODEL OM-1

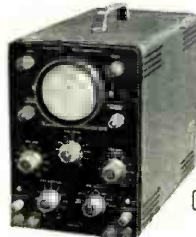

C MODEL OL-1



MODEL MM-1  
VOM



MODEL M-1  
HANDITESTER



MODEL V-7A  
VTVM

A **Heathkit ETCHED CIRCUIT** COLOR TV  
**5" OSCILLOSCOPE KIT**

Amplifier response essentially flat (+2 db -5 db) from 5 mc down to 2 cps without extra switching. Sweep oscillator allows single-cycle observation up to 500,000 cps. and even higher. Uses etched metal circuit boards. Push-pull vertical and horizontal amplifiers—built in peak-to-peak calibrating source—step attenuated input—preformed and cabled wiring harness. A professional scope ideal for color TV work in the lab or service shop. 11-tube circuit features 5UP1 CRT.

MODEL O-10  
**\$69<sup>50</sup>**  
Shpg. Wt.  
21 Lbs.

B **Heathkit ETCHED CIRCUIT**  
**5" OSCILLOSCOPE KIT**

The OM-1 has many big scope features, including 5", 5BP1 cathode ray tube, and yet it is priced reasonably. Features etched metal circuit boards. Incorporates 3 step input attenuator—phasing control—built-in peak-to-peak voltage calibrator—and push-pull vertical and horizontal amplifiers. Vertical amplifier flat within ±3 db from 2 cps to 200 kc. Sweep circuit functions from 20 cps to 100,000 cps. An excellent general purpose scope for service shop or lab.

MODEL OM-1  
**\$49<sup>50</sup>**  
Shpg. Wt.  
21 Lbs.

C **Heathkit ETCHED CIRCUIT**  
**3" OSCILLOSCOPE KIT**

Has many of the features of the Model OM-1, yet is smaller in physical size for portability, and for use in the home workshop. Employs etched metal circuit boards. Vertical frequency response within ±3 db from 2 cps to 200 kc. Sweep generator operates from 20 to 100,000 cps. The 8-tube circuit features a type 3GP1 cathode ray tube. Measures only 9½" h. x 6½" w. x 11¼" d.

MODEL OL-1  
**\$29<sup>50</sup>**  
Shpg. Wt.  
14 Lbs.

**Heathkit 20,000 OHMS/VOLT  
VOM KIT**

Requires no external power. Sensitivity is 20,000 ohms/v. DC and 5,000 ohms/v. AC. Black Bakelite case—4½" 50 ua. meter—1% precision resistors. AC and DC ranges are 0-1.5 5, 50, 150, 500, 1500, and 5000 volts. Direct current ranges are 0-150 ua., 15 ma., 150 ma., 500 ma. and 15 a. Resistance multipliers are X1, X100, and X10,000. DB range from -10 db to +65 db. Especially valuable in portable applications.

MODEL MM-1  
**\$29<sup>50</sup>**  
Shpg. Wt.  
6 Lbs.

**Heathkit HANDITESTER KIT**

This compact model easily slips into tool box, glove compartment, or coat pocket. Valuable as "extra" instrument in service shop, and ideal for the home experimenter. Very popular with appliance repairmen, and electricians. Measures AC or DC voltage at 0-10, 30, 300, 100, and 5000 volts. Direct current ranges are 0-10 ma., and 0-100 ma. Attractive black Bakelite case.

MODEL M-1  
**\$14<sup>50</sup>**  
Shpg. Wt.  
3 Lbs.

**Heathkit ETCHED CIRCUIT VACUUM TUBE  
VOLTMETER KIT**

The V-7A is used in scientific laboratories, technical schools, service shops, ham shacks, and in the home workshop. Features 200 ua. meter, 1% precision resistors, and etched metal circuit board. Measures DC voltage, ACV (rms), AVC (peak-to-peak), and resistance. AC (rms) and DC voltage ranges are 0-1.5, 5, 15, 50, 150, 500, and 1500 volts. Peak-to-peak ranges are 4, 14, 40, 140, 400, 1400, and 4000 volts. Ohmmeter ranges provide multipliers of X1, X10, X100, X1000, X10K, X100K, and X1 megohm. DB scale also provided. 11 megohm input impedance.

MODEL V-7A  
**\$24<sup>50</sup>**  
Shpg. Wt.  
7 Lbs.

**NEW** **Heathkit PROFESSIONAL RADIATION COUNTER KIT**



- ▶ Modern circuit design for maximum sensitivity and reliability.
- ▶ Employs 900 volt Bismuth tube in beta/gamma sensitive probe.
- ▶ Both visual and aural indicators for radiation level.

This radiation counter features ranges of 0-100, 600, 6000, and 60,000 counts per minute and 0-.02, .1, 1, and 10 milliroentgens per hour. The probe uses a 6306 Bismuth tube. The 5-tube circuit employs a 4½", 200 ua. meter, calibrated in cpm. and mR/hr. Also aural signal provided from panel-mounted speaker. Simple to build from the instructions supplied, even for a beginner.

MODEL RC-1  
**\$79<sup>95</sup>**  
Shpg. Wt.  
8 Lbs.



**HEATH COMPANY** A Subsidiary of Daystrom, Inc. **BENTON HARBOR 15, MICH.**





### Heathkit PROBE KITS



### ETCHED CIRCUIT PEAK-TO-PEAK

No. 338-C. \$5.50  
Shpg. Wt. 2 Lbs.

Use to read peak-to-peak voltages on DC scale of 11-megohm VTVM. Read direct on VTVM scales from 5 kc to 5 mc.

### ETCHED CIRCUIT RF

No. 309-C. \$3.50

Shpg. Wt. 1 Lb.

Use with any 11 megohm VTVM for RF measurements up to 250 mc with  $\pm 10\%$  accuracy. Employs etched circuit.

### 30,000 VOLT D.C. HIGH VOLTAGE

No. 336. \$4.50  
Shpg. Wt. 2 Lbs.

Use to measure high DC voltage with VTVM. Precision multiplier resistor mounted inside plastic probe. Multiplication factor of 100 on Heathkit 11-megohm VTVM.

PROBES  
FOR VTVM

### PROBES FOR SCOPE



### LOW CAPACITY

No. 342. \$3.50

Shpg. Wt. 1 Lb.

Low capacity probe prevents circuit loading. Features variable capacitor for correct impedance matching. Ratio of attenuation can be controlled.



### SCOPE DEMODULATOR

No. 337-C. \$3.50

Shpg. Wt. 1 Lb.

This probe functions like detector to pass only modulation of signal, and not signal itself. Applied voltage limits are 30 volts rms, and 500 VDC.

## Heathkit ELECTRONIC SWITCH KIT

This instrument allows simultaneous oscilloscope observation of two input signals by producing both signals, alternately, at its output. circuit provides 4 switching rates, selected by panel switch. Provides gain for input signals, and features frequency response of  $\pm 1$  db 0-100 kc. Employs seven miniature tubes. Sync output provided to control scope sweep. Functions at signal levels as low as 0.1 volt.

of two input  
signals, alternately,  
at its output.

MODEL S-3

**\$21<sup>95</sup>**

Shpg. Wt. 8 Lbs.

## Heathkit VARIABLE VOLTAGE REGULATED POWER SUPPLY KIT

This power supply provides regulated DC output that can be controlled from 0 to 500 volts. Supplies up to 130 ma at 200 VDC, and up to 10 ma at 450 VDC. Large panel meter monitors output voltage or current. Supplies filament voltage at 6.3 volts AC (4 amperes). Filament and B+ circuits isolated from ground. Ideal lab power supply for use in experimental work.

manually con-

MODEL PS-3

**\$35<sup>50</sup>**

Shpg. Wt. 17 Lbs.

## Heathkit ISOLATION TRANSFORMER KIT

Provides isolation between the power line and equipment under test. No direct connection between primary and secondary. Keeps chassis of AC-DC sets "cold." Fused in the primary circuit. Also provides manual voltage control from 90 volts to 130 volts for test purposes. Rated at 100 volt-amperes continuously. Panel meter monitors output voltage.

test. No direct

MODEL IT-1

**\$16<sup>50</sup>**

Shpg. Wt. 9 Lbs.

## Heathkit DIRECT READING CAPACITY METER KIT

This unique instrument indicates capacity in mmf, or mfd, directly on a  $4\frac{1}{2}$ " 50 ua. meter. Ranges are 0 to 100 mmf, 0-1000 mmf, 0-.01 mfd, and 0-.1 mfd. Residual capacity less than 1 mmf. Scales are linear. Instrument not susceptible to hand capacity effects. Will measure even small value trimmers or variable air capacitors.

MODEL CM-1

**\$29<sup>50</sup>**

Shpg. Wt.  
7 Lbs.

## Heathkit VIBRATOR TESTER KIT

Checks condition of vibrators under operating conditions. Tests 6-volt vibrators only. Use in conjunction with BE-4 battery eliminator, or similar variable power source. Indicates vibrator quality on large "good-bad" scale. Tests both inter-rupter and self-rectifier types. 5 different sockets.

MODEL VT-1

**\$14<sup>50</sup>**

Shpg. Wt.  
6 Lbs.

## Photographers! Heathkit ENLARGER TIMER KIT

Use to time photographic enlarger. "Time" dial allows settings of from 5 to 60 seconds. Will also control safe-light "on" when enlarger is "off." Enlarger and safelight plug into receptacles on front panel. Handles up to 350 watts. Ideal device to free operator for other operations, and very simple to build. Compact plastic case.

MODEL ET-1

**\$11<sup>50</sup>**

Shpg. Wt.  
3 Lbs.



MODEL S-3  
ELECTRONIC SWITCH KIT



MODEL PS-3  
VARIABLE VOLTAGE  
REGULATED  
POWER SUPPLY KIT



MODEL IT-1  
ISOLATION  
TRANSFORMER KIT



MODEL CM-1  
CAPACITY  
METER KIT



MODEL VT-1  
VIBRATOR TESTER KIT

**HEATH COMPANY** A Subsidiary of Doystrom, Inc. BENTON HARBOR 15, MICH.



MODEL TS-4  
TV SWEEP GENERATOR KIT



MODEL LG-1  
LABORATORY GENERATOR KIT

# HEATHKIT®

## instruments

CONTAIN HIGH QUALITY  
COMPONENTS THROUGHOUT.  
EACH AN OUTSTANDING DOLLAR  
VALUE IN TEST EQUIPMENT.



MODEL LP-2  
LINEARITY PATTERN  
GENERATOR KIT



MODEL  
SG-8  
RF SIGNAL  
GENERATOR  
KIT



MODEL BE-4  
6-12 VOLT BATTERY ELIMINATOR  
KIT

### Heathkit TV SWEEP GENERATOR KIT

All-electronic sweep circuit eliminates mechanical hum and vibration. Features improved linearity—effective AGC—flat output—0 to 40 mc sweep. Covers all frequencies for black and white or color TV work, as well as FM. High output for alignment of tuners, IF strips, boosters, etc. Fundamental output from 4 to 220 mc in four bands. Has crystal oscillator (4.5 mc and multiples thereof), and variable marker covering 19 to 60 mc—up to 180 mc on harmonics. Provision for external marker. Effective two-way blanking.

MODEL TS-4  
**\$49.50**  
Shpg. Wt.  
16 Lbs.

### Heathkit LABORATORY GENERATOR KIT

This signal generator covers from 100 kc to 30 mc on fundamentals in 5 bands. 400 cycle modulation variable from 0 to 50%. RF output up to 100,000 microvolts. Meter reads RF output or percentage of modulation. Fixed step and variable output attenuation. Voltage regulation, double copper-plated shielding for stability, and other "extras." Provision for external modulation. Output impedance 50 ohms.

MODEL LG-1  
**\$39.50**  
Shpg. Wt.  
16 Lbs.

### Heathkit LINEARITY PATTERN GENERATOR KIT

Supplies information for white dots, cross-hatch pattern, horizontal bar pattern, or vertical bar pattern. Use for adjustment of vertical and horizontal linearity, picture size, aspect ratio, and focus. Dot pattern is a *must* for color convergence adjustments. Clip merely connects to antenna terminals of TV set. Panel provision for external sync if desired. Covers channels 2 to 13. 5 to 6 vert. bars and 4 to 5 hor. bars.

MODEL LP-2  
**\$22.50**  
Shpg. Wt.  
7 Lbs.

### Heathkit SIGNAL GENERATOR KIT

This tried and proven generator covers 160 kc to 110 mc on fundamentals in five bands, and calibrated harmonics extend to 220 mc. Very popular in service shops, laboratories, and home workshops. RF output is in excess of 100,000 microvolts, controlled by a variable and a fixed-step attenuator. Output is pure RF, RF modulated at 400 cps, or 400 cps audio for amplifier testing.

MODEL SG-8  
**\$19.50**  
Shpg. Wt.  
8 Lbs.

### Heathkit BATTERY ELIMINATOR KIT 6-12 volt

This up-to-date battery eliminator will supply either 6 or 12-volt output to take care of auto radios from even the most modern automobiles. Output voltage is variable 0-8 volts DC or 0-16 volts DC. Will deliver up to 15 amperes at 6 volts or up to 7 amperes at 12 volts. Two 10,000 microfarad output filter capacitors insure smooth DC output. Panel meters monitor output current. Will double as a battery charger. Definitely required for automobile radio service work.

MODEL BE-4  
**\$31.50**  
Shpg. Wt.  
17 Lbs.

### Heathkit CONDENSER CHECKER KIT



Measures paper, mica, ceramic, and electrolytic capacitors in 4 ranges from .00001 to 1,000 microfarads. Indicates condenser value and quality. Also measures resistance from 100 ohms to 5 megohms. All values indicated directly on panel scale, after adjusting for null on electron beam "eye" tube. No calculations necessary. A valuable instrument in service or laboratory applications.

MODEL C-3  
**\$19.50**  
Shpg. Wt.  
7 Lbs.

### Heathkit SUBSTITUTION BOX KITS



Model CS-1 **\$5.50** Shpg. Wt. 2 Lbs.

This unit provides switch selection of capacitor values from .001 mfd. to .22 mfd, in 18 RTMA standard values. Kit includes 18" flexible leads with alligator clips.

Model RS-1 **\$5.50** Shpg. Wt. 2 Lbs.

Provides switch selection of resistances from 15 ohms to 10 megohms. in 36 RTMA values. Resistors are 1 watt, 10%. Extremely valuable in all types of electronic activity.



**HEATH COMPANY** A Subsidiary of Daystrom, Inc. **BENTON HARBOR 15, MICH.**

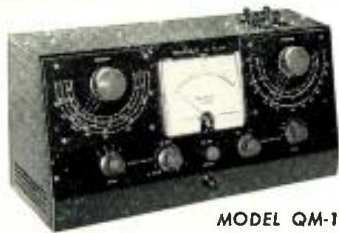

MODEL QM-1  
"Q" METER KIT



MODEL TC-2  
TUBE  
CHECKER  
KIT



MODEL CC-1  
CATHODE RAY TUBE CHECKER KIT



MODEL DR-1  
DECADE RESISTANCE  
KIT



MODEL DC-1  
DECADE CONDENSER  
KIT



MODEL IB-2  
IMPEDANCE BRIDGE KIT



MODEL TC-2P  
PORTABLE  
TUBE CHECKER  
KIT

### Heathkit "Q" METER KIT

The model QM-1 measures the Q of inductances and the RF resistance and distributed capacity of coils. Employs a  $4\frac{1}{2}$ " 50 microampere meter for direct indication. Features built-in signal source for tests at frequencies of 150 kc to 18 mc in four ranges. Measures capacity from 40 mmf to 450 mmf with  $\pm 3$  mmf. Indispensable for coil winding, and determining unknown capacitor values. A worthwhile addition to the laboratory or ham shack at a very low price.

MODEL QM-1

**\$44.50**

Shpg. Wt.  
14 Lbs.

### Heathkit DECADE RESISTANCE KIT

Provides 20 1% precision resistors that are switched to provide values from 1 to 99,999 ohms, in 1-ohm steps. High quality components for precision lab work.

MODEL DR-1

**\$19.50**

Shpg. Wt.  
4 Lbs.

### Heathkit DECADE CONDENSER KIT

Employs high precision 1% silver-mica capacitors for switch selection of values from 100 mmf to 0.111 mfd. in steps of 100 mmf. Employs ceramic switches for reduced leakage. Invaluable in the laboratory.

MODEL DC-1

**\$16.50**

Shpg. Wt.  
3 Lbs.

### Heathkit IMPEDANCE BRIDGE KIT

This bridge features built-in oscillator and amplifier. Measures resistance, capacitance, inductance, dissipation factors of condensers, and storage factor of inductance. D, Q, and DQ functions combined in one control. Employs  $\frac{1}{2}$ % resistors and  $\frac{1}{2}$ % silver-mica capacitors. 100-0-100 ua. meter indicates null. Two-section CRL dial provides ten separate "units" with accuracy of .5%. Fractions of units read on variable control.

MODEL IB-2

**\$59.50**

Shpg. Wt.  
12 Lbs.

### Heathkit TUBE CHECKER KIT

You can afford your own tube tester, even if you are an experimenter, or only do part time service work. Uses a  $4\frac{1}{2}$ " meter with 3-color meter face for simple "good-bad" indications of tube

quality, on the basis of emission. Will test all tubes commonly encountered in radio and TV service work. 14 different filament voltage values provided. Built-in roll chart—ten 3 position lever switches for open or short tests on each tube element. Space provided for future socket addition.

MODEL TC-2

**\$29.50**

Shpg. Wt.  
12 Lbs.

### Heathkit PORTABLE TUBE CHECKER KIT

The Model TC-2P is identical to the Model TC-2 except that it is housed in a rugged carrying case. This two-tone case is finished in proxylon impregnated fabric. The cover is detachable, and the hardware is brass plated. Ideal for home service calls.

MODEL TC-2P

**\$34.50**

Shpg. Wt.  
15 Lbs.



### Heathkit TV PICTURE TUBE TESTER ADAPTER

MODEL 355

Shpg. Wt. **\$4.50**  
1 Lb.

Use with TC-2. Tests picture tubes for emission and shorts. 12-pin socket, 4 ft. cable, octal connector, and technical data. Not a kit.

### Heathkit CATHODE RAY TUBE CHECKER KIT

Indicates condition of CRT on large "good-bad" scale. Spring-loaded switches protect operator. Checks all electro-magnetic deflection picture tubes normally encountered in TV servicing. Housed in portable case for service calls. Supplies all operating potentials. Tests for shorts, leakage, and emission. Checks tubes on the work bench, in the carton, or in the set. Features shadowgraph test (spot of light on the screen).

MODEL CC-1

**\$22.50**

Shpg. Wt.  
10 Lbs.

### Heathkit AC VACUUM TUBE VOLTMETER KIT

Here is a VTVM designed especially for audio work. Combines high impedance, wide frequency range, and high sensitivity. Frequency response, substantially flat from 10 cps to 50 kc. Sensitivity allows measurements as low as 1 mv at high impedance. Ranges are .01, .03, .1, .3, 1, 3, 10, 30, 100, and 300 volts rms. Total db range -52 to +52 db. 1 megohm input impedance at 1 kc.

MODEL AV-2

**\$29.50**

Shpg. Wt.  
5 Lbs.



**HEATH COMPANY** A Subsidiary of Daystrom, Inc. **BENTON HARBOR 15, MICH.**



**MODEL HD-1**  
HARMONIC DISTORTION METER KIT



**MODEL CR-1**  
CRYSTAL RECEIVER KIT



**MODEL AG-9**  
AUDIO GENERATOR KIT



**MODEL AG-8**  
AUDIO GENERATOR KIT



**MODEL AO-1**  
AUDIO OSCILLATOR KIT



**MODEL AA-1**  
AUDIO ANALYZER KIT



**MODEL BR-2**  
BROADCAST BAND RECEIVER KIT



**MODEL T-3**  
SIGNAL TRACER KIT

### Heathkit HARMONIC DISTORTION METER KIT

Designed for use with low distortion audio generator, (such as the Model AG-9). Measures harmonic distortion of audio amplifiers under a variety of conditions. Reads distortion on meter as percentage of input signal. Operates between 20 and 20,000 cps. High impedance VTVM built in for initial reference settings and final distortion readings. VTVM ranges are 0-1, 3, 10, and 30 volts full scale. 1% precision resistors employed. Distortion scales are 0-1, 3, 10, 30, and 100% full scale.

**MODEL HD-1**  
**\$49<sup>50</sup>**  
Shpg. Wt.  
13 Lbs.

### Heathkit AUDIO OSCILLATOR KIT (Sine Wave—Square Wave)

Produces sine wave or square wave signals from 20 to 20,000 cps in 3 ranges. Designed for use in service shop, or home workshop. Employs thermistor for output regulation. Features high level output, low distortion, and low impedance output. Produces sine waves for audio testing, or will produce good clean square waves with a rise time of only 2 microseconds. Very simple to build from complete instructions supplied.

**MODEL AO-1**  
**\$24<sup>50</sup>**  
Shpg. Wt.  
10 Lbs.

### Heathkit CRYSTAL RECEIVER KIT

This crystal radio covers standard broadcast band (540 to 1600 kc). Employs two high-Q tank circuits. A sealed germanium diode is used for detection—no critical "cat's whisker" adjustment. Kit includes pair of high impedance headsets, and is easy to build, even for a beginner. Requires no external power.

**MODEL CR-1**  
**\$7<sup>95</sup>**  
Shpg. Wt.  
3 Lbs.

### Heathkit AUDIO ANALYZER KIT

Combines AC VTVM, audio wattmeter, and intermodulation distortion analyzer in one instrument. Includes built-in high and low frequency oscillators for IM tests. VTVM ranges are .01, .03, .1, .3, 1, 3, 10, 30, 100, and 300 volts rms. Wattmeter ranges are .15 mw, 1.5 mw, 15 mw, 150 mw, 1.5 w, 15 w, and 150 w. IM scales are 1%, 3%, 10%, 30%, and 100%. Provides internal loads of 4, 8, 16, or 600 ohms. An extremely valuable instrument for the audio engineer, or for the serious audiophile.

**MODEL AA-1**  
**\$59<sup>50</sup>**  
Shpg. Wt.  
13 Lbs.

### Heathkit AUDIO GENERATOR KIT

Low distortion audio generator (less than .1%). Ideal for use with Model HD-1, or in other applications requiring low signal distortion. Frequency accuracy within  $\pm 5\%$ . Features step-type tuning from 10 cps to 100 kc, with three rotary switches that provide two significant figures and a multiplier. Output monitored on large  $4\frac{1}{2}$ " meter. Meter calibrated for output voltage or db. Output ranges are 0-.003, .01, .03, .1, .3, 1, 3, and 10 volts.

**MODEL AG-9**  
**\$34<sup>50</sup>**  
Shpg. Wt.  
8 Lbs.

### Heathkit BROADCAST BAND RECEIVER KIT

Build your own radio with confidence, even if you are a beginner. Features transformer power supply, miniature tubes, built-in antenna,  $5\frac{1}{2}$ " PM speaker, and planetary tuning from 550 kc to 1600 kc. Complete step-by-step instructions supplied.

**MODEL BR-2**  
**\$17<sup>50</sup>**  
(less cabinet)  
Shpg. Wt.  
10 Lbs.

Cabinet, as shown, available separately.

### Heathkit AUDIO GENERATOR KIT

This generator covers from 20 cps to 1 mc in 5 ranges. Output constant within  $\pm 1$  db from 20 cps to 400 kc, and down only 3 db at 600 kc. Produces good sine wave with distortion percentage below .4% from 100 cps through the audio range. Provides 10 volts output under no load conditions. Has continuously variable and step-type attenuator with settings of 1 millivolt, 100 millivolts, 1 volt, and 10 volts. Cathode follower output.

**MODEL AG-8**  
**\$29<sup>50</sup>**  
Shpg. Wt.  
11 Lbs.

### Heathkit VISUAL-AURAL SIGNAL TRACER KIT

Features a high-gain RF input channel for signal tracing and troubleshooting from the receiver antenna input clear through all RF and IF stages. Separate low-gain channel for audio circuit exploration. Built-in loudspeaker provides audio response, while electron beam "eye" tube gives visual indication. Ideal for signal tracing in AM, FM, and TV receivers. Built-in wattmeter and noise locating circuit.

**MODEL T-3**  
**\$23<sup>50</sup>**  
Shpg. Wt.  
9 Lbs.

**HEATH COMPANY** A Subsidiary of Daystrom, Inc. BENTON HARBOR 15, MICH.

## Heathkit DX-100 PHONE & CW TRANSMITTER KIT

This transmitter is rapidly becoming the accepted standard in its price class. 100 watts RF output—built-in power supplies—built-in VFO and modulator—bandswitching on 160, 80, 40, 20, 15, 11, and 10 meters—phone or CW operation. 100 watts output on phone, and 120 watts on CW. TVI suppressed—pi network output coupling—extensive shielding—matches 50 to 600 ohms—high quality components. Uses 1625 tubes in push-pull to modulate 6146 tubes in parallel. Schematic and specifications available on request.

MODEL  
DX-100  
**\$189.50**

Shpg. Wt.  
107 Lbs.

## Heathkit DX-35 PHONE & CW TRANSMITTER KIT

This exciting new kit features bandswitching phone and CW operation on 80, 40, 20, 15, 11, and 10 meters. Plate power input to 65 watts on CW, with controlled-carrier modulation peaks to 50 watts on phone. Features built-in modulator, power supplies, pi network output circuit. Panel meter reads grid or plate current for 6146 final. Schematic and specifications on request.

MODEL DX-35  
**\$56.95**

Shpg. Wt.  
24 Lbs.

## Heathkit CW AMATEUR TRANSMITTER KIT

Outstanding dollar-per-watt value! 30-35 watts plate power input, bandswitching for 80, 40, 20, 15, 11, and 10 meters. Crystal or external VFO excitation. 52 ohm output—key click filter—copper-plated chassis—pre-wound coils. Uses 6AG7 oscillator, 6L6 final.

MODEL AT-1  
**\$29.50**

Shpg. Wt.  
15 Lbs.

## Heathkit VFO KIT

Go VFO for added convenience and flexibility. Covers 160-80-40-20-15-11 and 10 meters. Three basic oscillator frequencies provide better than 10 volt average RF output. Plug for crystal socket of transmitter. VR tube for stability. Requires only 250 VDC at 20 ma, and 6.3 VAC at 0.45 A.

MODEL VF-1  
**\$19.50**

Shpg. Wt.  
7 Lbs.

## Heathkit ANTENNA COUPLER KIT

Matches between transmitter and a long-wire, end-fed antenna. Incorporates an L-type filter to attenuate signals above 36 mc and reduce TVI. 52-ohm coaxial input. Tapped inductor and variable capacitor. Neon RF indicator—simple to build. Handles up to 75 watts, 10 through 80 meters. Use with AT-1 or DX-35.

MODEL AC-1  
**\$14.50**

Shpg. Wt.  
4 Lbs.

## Heathkit "Q" MULTIPLIER KIT

Tunes any signal within 1F of receiver, with effective Q of approximately 4,000. Sharp "peak" or "null" surpasses crystal filter in operation. Use with 450-460 kc 1F. Will not function with AC-DC receivers. Requires 6.3 VAC at 300 ma, and 150-250 VDC at 2 ma. Cable and plugs supplied.

MODEL QF-1  
**\$9.95**

Shpg. Wt.  
3 Lbs.

## Heathkit COMMUNICATIONS TYPE ALL BAND RECEIVER KIT

Unusual sensitivity and selectivity for price. Covers 550 kc to 30 mc in 4 bands. AC power supply—electrical bandspread—antenna trimmer—separate RF and AF gain controls—noise limiter—headphone jacks—AGC—BFO. Cabinet available separately as shown. Part 91-15A, shipping weight 5 lbs. \$4.50.

MODEL AR-3  
**\$27.95**

(Less Cabinet)  
Shpg. Wt.  
12 Lbs.

## Heathkit GRID DIP METER KIT

Use for determining unknown frequency, for checking resonance of tuned circuits, or for adjusting wave traps. Equally valuable in ham shack, service shop, or laboratory. Features 500 ua. meter with sensitivity control. Covers 2 mc to 250 mc with five coils, supplied with kit. Coils pre-wound, dial scale pre-calibrated.



MODEL  
GD-1B  
**\$19.50**

Shpg. Wt.  
4 Lbs.



## Heathkit ANTENNA IMPEDANCE METER KIT

Use this instrument, with a source of RF signal, to determine antenna impedance, line impedance, and to solve impedance matching problems with fixed or mobile antennas or transmission lines. Also, will double as a field strength indicator, or phone monitor. Uses 100 ua. meter. Covers 0 to 600 ohms.

MODEL AM-1  
**\$14.50** Shpg. Wt.  
2 Lbs.



MODEL DX-100  
PHONE & CW TRANSMITTER KIT



MODEL DX-35  
PHONE & CW TRANSMITTER KIT



MODEL AT-1  
CW AMATEUR TRANSMITTER KIT



MODEL VF-1  
VFO KIT



MODEL AC-1  
ANTENNA  
COUPLER KIT



MODEL QF-1  
"Q" MULTIPLIER  
KIT



MODEL AR-3  
ALL BAND RECEIVER KIT

**HEATH COMPANY** A Subsidiary of Daystrom, Inc. **BENTON HARBOR 15, MICH.**



MODEL W-5M

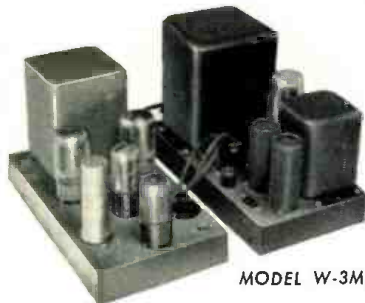

MODEL W-3M



MODEL W-4M

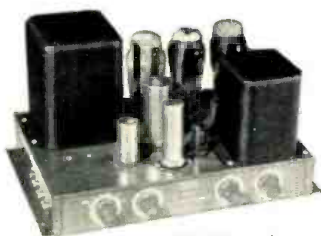

MODEL A-9B



MODEL A-7D

## Heathkit ADVANCE-DESIGN HIGH FIDELITY AMPLIFIER KIT

This 25 watt amplifier incorporates the "extra" features required for really outstanding performance, and yet is priced within the range of the average audiophile. Employs KT66 output tubes in push-pull, and features the famous Peerless output transformer. Response is within  $\pm 1$  db from 5 cps to 160 kc at 1 watt. Harmonic distortion only 1% at 25 watts. 20 to 20,000 cps. IM distortion only 1% at 20 watts. Output impedance is 4, 8, or 16 ohms. Hum and noise are 99 db below rated output. Features "tweeter saver," and unique balancing circuit. Handles power peaks up to 42 watts.

### KIT COMBINATIONS:

**W-5M Amplifier Kit:** Consists of main amplifier and power supply, all on one chassis. Complete with all necessary parts, tubes, and comprehensive manual.

**W-5 Combination Amplifier Kit:** Consists of W-5M Amplifier Kit listed above plus Heathkit Model WA-P2 Preamplifier Kit. Complete with all necessary parts, tubes, and construction manuals.

Express only—Shipping weight 38 lbs. . . . . **\$79.50**

Express only

**\$59.75**

Shpg. Wt.  
37 Lbs.

## Heathkit DUAL-CHASSIS HIGH FIDELITY AMPLIFIER KIT

The Model W-3M features the famous Acrosound TO-300 "ultra linear" output transformer. It uses 5881 tubes and has a frequency response within  $\pm 1$  db from 6 cps to 150 kc at 1 watt. Harmonic distortion only 1% at 21 watts. IM distortion at 20 watts only 1.3% at 60 and 3,000 cps. Power output is 20 watts. Output impedance is 4, 8, or 16 ohms. Hum and noise is 88 db below 20 watts. A very popular high fidelity unit. Main amplifier and power supply on separate chassis.

### KIT COMBINATIONS:

**W-3M:** Consists of main amplifier and power supply for separate chassis construction. Includes all tubes and components necessary for assembly.

**W-3:** Consists of W-3M Kit listed above plus Heathkit Model WA-P2 Preamplifier described on opposite page.

Express only—Shipping weight 37 lbs. . . . . **\$69.50**

Express only

**\$49.75**

Shpg. Wt.  
29 Lbs.

## Heathkit SINGLE-CHASSIS HIGH FIDELITY AMPLIFIER KIT

Model W-4A is the original low-priced Williamson Amplifier Kit. A Chicago output transformer and 5881 output tubes are featured. Frequency response is  $\pm 1$  db from 10 cps to 100 kc at 1 watt. Harmonic distortion only 1.5% at 20 watts. IM distortion only 2.7%. 20 watts output at 4, 8, or 16 ohms. Hum and noise 95 db below 20 watts. A tried and proven unit featuring a "polished" circuit that may be depended on for reliable high fidelity performance.

### KIT COMBINATIONS:

**W-4AM:** Consists of main amplifier and power supply for single chassis construction. Includes all tubes and components necessary for assembly.

**W-4A:** Consists of W-4AM Kit listed above plus Heathkit Model WA-P2 Preamplifier described on opposite page.

Express only—Shipping weight 35 lbs. . . . . **\$59.50**

Express only

**\$39.75**

Shpg. Wt.  
28 Lbs.

## Heathkit 20-WATT HIGH FIDELITY AMPLIFIER KIT

This amplifier can provide you with high fidelity at a surprisingly low price. Preamplifier built into same chassis as main amplifier. Four switch selected, compensated inputs are available, as are bass and treble tone controls, providing necessary flexibility for home or public address installations at a minimum investment. Features full 20-watt output using push-pull 6L6 tubes. Employs miniature tube types in preamp for low hum and noise. Frequency response is  $\pm 1$  db from 20 to 20,000 cps. Harmonic distortion only 1% at full output. Shop and compare—a real "best buy" for you.

MODEL A-9B

**\$35.50**

Shpg. Wt.  
23 Lbs.

## Heathkit 7-WATT AMPLIFIER KIT

The 7-watt output of this amazing little amplifier is more than adequate for normal home installations. Using a tapped-screen output transformer of new design, its frequency response is  $\pm 1\frac{1}{2}$  db from 20 to 20,000 cps. It provides good sensitivity, with surprisingly low distortion. Transformer tapped at 4, 8, and 16 ohms. Push-pull output. Separate bass and treble tone controls are provided.

**MODEL A-7E:** Same as Model A-7D, but with stage of preamplification. Extra gain for low level cartridges. RIAA compensation. Shipping weight 10 lbs. . . . . **\$18.50**

MODEL A-7D

**\$16.95**

Shpg. Wt.  
10 Lbs.

**SPECIAL NOTE:** Don't overlook the possibilities of a hi-fi system consisting of the FM-3, the Model A-7E, and the Model SS-1 Speaker System. For only \$82.95, you can have high fidelity in your home.

**HEATH COMPANY** A Subsidiary of Daystrom, Inc. **BENTON HARBOR 15, MICH.**

## Heathkit HIGH FIDELITY PREAMPLIFIER KIT

Designed specifically for use with Heathkit main amplifiers. Features five separate switch-selected input channels, each with its own input level control. Four-position turnover and roll-off controls for record equalization. Separate bass and treble tone controls. Special hum control to insure minimum hum level. Will do justice to finest program sources. Beautiful satin-gold finish.



MODEL WA-P2  
**\$197<sup>5</sup>** (with cabinet)  
 Shpg. Wt. 7 lbs.

## Heathkit AM TUNER KIT

Designed for use with high fidelity systems. Low distortion voltage-doubler detector. Covers 550 to 1600 kc. 20 kc IF bandwidth. Audio response  $\pm 1$  db from 20 cps to 2 kc. 6 db signal-to-noise ratio at 2.5 microvolts. RF and IF coils pre-aligned. Power supply built-in. Efficient, modern circuit. Matches WA-P2 and FM-3 in color and style.



MODEL BC-1  
**\$245<sup>0</sup>** (with cabinet)  
 Shpg. Wt. 8 lbs.

## Heathkit HIGH FIDELITY FM TUNER KIT

This FM tuner offers sensitivity, selectivity, and stability, not expected at this price level. Efficient 7-tube circuit is entirely new, and incorporates AGC, cascode front end, temperature compensated oscillator, built-in power supply, and other outstanding design features. Only minimum adjustments required after assembly with pre-aligned IF and ratio transformers. Sensitivity is better than 10 microvolts for 20 db of quieting. Covers 88 to 108 mc.



MODEL FM-3  
**\$245<sup>0</sup>** (with cabinet)  
 Shpg. Wt. 7 lbs.

## Heathkit

### ELECTRONIC CROSS-OVER KIT



MODEL XO-1  
**\$189<sup>5</sup>** Shpg. Wt. 6 lbs.

The XO-1 separates high and low frequencies at selectable crossover points, to feed two separate power amplifiers, one for high frequencies and one for low frequencies. Speakers are then connected to the amplifiers directly, without the usual LC crossover. Separate level controls provided for both outputs. The XO-1 consumes no audio power. Crossover frequencies are 100, 200, 400, 700, 1200, 2000, and 3500 cps. Attenuation is 12 db per octave.

# HEATHKIT<sup>®</sup>

## HIGH FIDELITY SPEAKER SYSTEM

The Models SS-1 and SS-1B are matched so that when the smaller unit is placed on top of the larger unit, the appearance of a single piece of furniture is achieved. They form an integrated 4-speaker system.

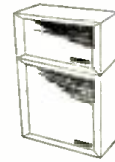

### Heathkit HIGH FIDELITY SS-1 SPEAKER SYSTEM KIT



MODEL SS-1  
**\$399<sup>5</sup>** Shpg. Wt. 30 lbs.

This speaker system employs two Jensen speakers to cover the frequency range from 50 to 12,000 cps. Response is within  $\pm 5$  db through this range. Built-in crossover functions at 1600 cps. System rated at 25 watts, with nominal impedance of 16 ohms. Enclosure is a ducted-port bass reflex type. The attractive "picture frame" molding blends with any decorating scheme. You merely assemble the cabinet, wire the speakers and crossover network, and treat the furniture-grade plywood in the finish of your choice.

### Heathkit HIGH FIDELITY SS-1B SPEAKER SYSTEM KIT

This Range Extending Speaker System employs a 15" woofer and a super tweeter to cover the frequencies between 35 and 600 cps, and between 4000 and 16,000 cps. When used with the Model SS-1, it extends the frequency range at both ends of the spectrum for a total coverage of  $\pm 5$  db from 35 to 16,000 cps. Provides unbelievably rich sound over the audio range.



MODEL SS-1B  
**\$999<sup>5</sup>** Shpg. Wt. 80 lbs.

Exposed panels are furniture grade plywood, suitable for light or dark finish of your choice. All parts are pre-cut and ready for assembly. The kit includes necessary crossover circuits and balance control. Crossover frequencies are 600, 1600, and 4,000. Power rating is 35 watts for speech and music. Nominal impedance is 16 ohms.

The SS-1B, alone, measures 29" high by 23" wide by 17½" deep.

## ORDER BLANK

NOTE: All prices subject to change without notice.

Enclosed find ( ) check ( ) money order for

Please ship C.O.D. ( ) postage enclosed for \_\_\_\_\_ pounds.

On Express orders do not include transportation charges — they will be collected by the express agency at time of delivery.

ON PARCEL POST ORDERS include postage for weight shown. ORDERS FROM CANADA and APO's must include full remittance.

Name \_\_\_\_\_

Address \_\_\_\_\_

City & Zone \_\_\_\_\_ State \_\_\_\_\_

(PLEASE PRINT)

### SHIP VIA

Parcel Post

Express

Freight

Best Way

QUANTITY	ITEM	MODEL NO.	PRICE

**HEATH COMPANY** A Subsidiary of Daystrom, Inc. BENTON HARBOR 15, MICH.



## Only planned high fidelity can give you true high fidelity!

Putting together a hi-fi system for your home *can be simple*—and it probably will cost a lot less than you think! Here at MusiCraft we offer the kind of information and guidance that will help you get started right and avoid mistakes.

As you may know, possible combinations of components are practically

limitless. We're happy to help you choose what will best suit your home and your budget. You can start small and add as you wish.

Stop in at MusiCraft soon or write us for further information. Let us help you plan the *kind* of high fidelity system that will give you *true* high fidelity.

Send your name and address if you would like to be on our mailing list for our announcements. Would you like a free copy of "Understanding High Fidelity"?



If you want to "build-it-yourself" and save—MusiCraft has a complete line of component parts in stock. The step-by-step directions are easy to follow—and you can feel free to call on us for any technical assistance you may need.

# MusiCraft

48 East Oak Street • Chicago 11, Illinois • DElaware 7-4150

Lowest Prices • Largest Component Selections • Complete Custom Installation Service

## ATTENTION

- Electronics Classes
- Study & Employee Groups
- Service Technician Organizations
- Club Members

Subscriptions to RADIO & TELEVISION NEWS—the world's leading electronics magazine—are available at special bulk rates for schools, study and employee groups, clubs, etc.

For information, write to:

**RADIO & TELEVISION NEWS**

Dept. 1016

366 Madison Ave.

New York 17, N. Y.

# Crystal Marker for TV Alignment

By GUY DEXTER

Add this simple circuit to your TV sweep generator for marking the 4.5 mc. sound channel point.

**S**ELF-EXCITED oscillators are not accurate enough for marking the 4.5 mc. sound channel point in visual TV alignment. Crystal-type marker oscillators are used for this purpose.

A number of earlier-model TV sweep generators still in use have no provision for crystal marker operation. A small external crystal oscillator would be desirable but usually is not built by the technician because of size and power requirements.

A transistorized crystal oscillator is an excellent alternative since it is small, requires little d.c. power, and has none of the complications introduced by power-line operation.

Fig. 1 is the circuit of a 4.5 mc. crystal oscillator employing a Sylvania 2N94A r.f. transistor. This is an "n-p-n" type. The circuit is resonated by means of a slug-tuned inductor, L<sub>1</sub>. Peak deflection of an a.c. v.t.v.m. connected temporarily to the output terminals of the oscillator and set to its 10-volt range will indicate resonance. The resonant voltage is approximately 5 volts r.m.s.

The total current drain of 13 milliamperes can be supplied by five series-connected penlite cells, six mercury cells (8.07 volts), or a small, flat 7½ volt battery like the Burgess 5540.

Fig. 1. Schematic of the crystal marker.

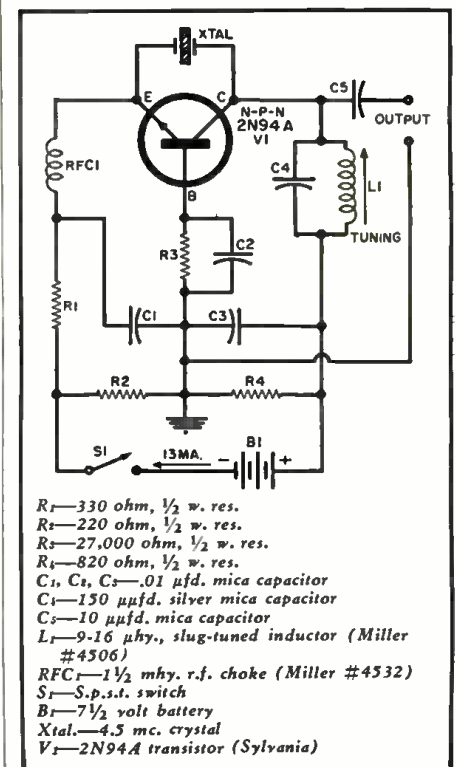



## Ham Special! Famous BC-645 XMITTER-RECEIVER



With DIAGRAM for Easy Conversion to CITIZENS' BAND! Makes wonderful mobile rig for 420-600 Mc. Easy to convert for phone or CW 2-way communication. CONVERSION DIAGRAM INCLUDED. This swell rig originally cost over \$1000—yours for practically a song! You get it all, in original factory carton. BRAND NEW, complete with 17 tubes, less power supply. Conversion instructions included. Shpg. wt. 25 lbs. . . . . **\$29.50**

PE-101C DYNAMOTOR for BC-645, has 12-24V input (easy to convert for 6V Battery operation) . . . . . **\$7.95**  
 UHF ANTENNA ASSEMBLY, for BC-645. Complete set of 10 Plugs for BC-645 . . . . . **\$5.50**  
 CONTROL BOX for above. . . . . **\$2.25**  
 SHOCK MOUNT . . . . . **1.25**  
 CONVERSION BOOKLET. Instructions for most useful surplus rigs. . . . . **\$2.50**

## HEADPHONES

Model	Description	Excellent Used	BRAND NEW
HS-23	High Impedance	\$2.25	\$4.35
HS-33	Low Impedance	1.95	4.65
HS-30	Low Imp. (featherwt.)	1.49	2.25
M-16/U	High Imp. (2 units)	2.75	7.95
CD-307A	Cords, with PL55 plug and JK26 Jack.		.99

HI-FI DYNAMIC HEADSET with Cushions  
 Freq. Range: 40-14000 CPS. No Distortion.  
 BRAND NEW . . . . . **\$5.95**



## MOBILE TRANSCEIVER DYNAMOTOR

Special Buy! Output 825 volts DC @ 225 Ma. Input 12 1/2 V @ 18.7 Amps, DC. Size 8 1/2" x 10 1/2" x 10 1/2".  
 BRAND NEW . . . . . **\$10.95**  
 Excellent Used . . . . . \$6.95

OTHER DYNAMOTOR VALUES:

Type	Input	Output	Excellent Used	BRAND NEW
DM-28	28V	224V .07A	\$1.95	\$4.95
DM-32A	28V 1.1A	250V .05A	2.95	5.95
DM-33A	28V 5A	575V .16A	1.95	3.95
	28V 7A	540V .25A	1.95	3.95
DM-34D	12V 2A	220V .080A	4.25	5.50
DM-37	25.5V 9.2A	625V .225A	5.95	8.95
DM-40	14V 3.4A	172V .138A	1.75	3.45
DM-53A	28V 1.4A	220V .080A	3.95	5.95
DM-64A	12V 5.1A	275V .150A		7.95
PE-73C	28V 20A	1000V .350A	8.50	11.50
PE-86	28V 1.25A	250V .050A	2.95	5.24
PE-103	6V	500V .160A		
	12V	500V .160A	19.50	34.50
PE-186	28V 11A	400V .400A		6.95

**SPECIAL G.E. DYNAMOTOR**  
 INPUT: 28 V. D.C. @ 19 A.  
 OUTPUT: 1000 V. D.C. @ .360 A.  
 Model 5D48B9A. BRAND NEW. . . . . **\$4.95**

**CATHODE RAY TUBES**  
 All Brand New in Original Packing

3CP1	\$.88	5BP4	\$2.22
3FP7	.88	5CP1	2.45
5BP1	2.22	9LP7	1.88



**BUBBLE SEXTANT**  
 Made for U.S. Armed Forces, by AGFA ANSCO. Actually worth \$150 or more! Has illuminated averaging disc for nighttime use. Complete with carrying case. **\$9.95**  
 Only . . . . .

**BENDIX DIRECTION FINDER**  
 MN-26-C. 12-tube remote control Navigation Direction Finder and communications receiver. 150 to 1500 Kc in 3 bands. 28 V. DC input. Ideal for commercial navigation on boats and planes. Complete installation comprises:  
 MN-26-C Receiver, used, with 12 tubes . . . . . **\$16.50**  
 MN-26-C With 12 Tubes, BRAND NEW . . . . . **\$22.50**  
 MN-20-E Rotatable Loop . . . . . **4.25**  
 MN-52 Azimuth Control Box . . . . . **2.95**  
**MN26Y BENDIX DIRECTION FINDER**  
 150 to 7 Mc. Complete with tubes, motor. **\$26.95**  
 BRAND NEW . . . . .  
 Used, like new, incl. tubes and dynamotor. . . . . **\$18.95**

**MICROPHONES**

Model	Description	Excellent Used	BRAND NEW
T-17	Carbon Hand Mike.	\$5.45	\$7.95
T-30	Carbon Throat Mike.	.33	.69
T-45	Navy Lip Mike.		.89
RS-38	Navy Type	2.45	4.95
T-24	Carbon Mike		3.95
TS-9	Handset		4.95

**TG-34A CODE KEYS**  
 Self-contained automatic unit, reproduces code practice signals recorded on paper tape. By use of built-in speaker, provides code-practice signals to one or more persons at speeds from 5 to 25 WPM.  
 BRAND NEW, in original carton. **\$16.88**  
 Tapes for above available.

## TERRIFIC LOW PRICE! APN/4 OSCILLOSCOPE



Easily converted for use on radio-TV Service Bench!  
**BRAND NEW**  
 Completely Assembled  
 Supplied only with 5" Scope type  
 5CP1 and  
 RCA Crystal Unit. . . . . **\$14.95**

## TS-100/AP OSCILLOSCOPE

**BRAND NEW** OUR **\$34.50**  
 (worth \$750) LOW PRICE

Can be used with linear sweep or general purpose test scope. Cables included. Also used with circular sweep as precision range calibrator. Self-contained in metal case 8" x 12 1/2" x 16" deep. For 110V 50 to 1200 cycles AC. Demilitarized, New, with all tubes including crystals and C. R. Tube.  
**GE WAVE METER TS1-111/CP. BRAND NEW.** With Carrying Case. . . . . **\$39.50**

**AIRCRAFT "ABC" POWER SUPPLY**  
 Made by Setchell-Carlson. Input 24V DC 8 amps. Output 1.5V @ 3A; 65V @ .010A; -6V. BRAND NEW, metal case 4 1/4 x 4 1/2 x 7 1/4".  
 Only . . . . . **\$4.24**

**BC-375 TRANSMITTER**  
 200-500 Kc, 1500-12500 Kc using plug-in units. 100 watts, Voice & CW.  
 Excel. Used, complete with all tubes. . . . . **\$22.50**  
 All Tuning Units for Above. . . . . \$2.25 and up.

**AIRCRAFT RADIO TRANSMITTER-RECEIVER**  
 RADIO SET SCR-AR-283. Consists of: RECEIVER, 201 to 398 Kc and 2500 to 7850 Kc. TRANSMITTER, 2500 to 7700 Kc. for unmodulated, tone-modulated, or voice. Here's what you get, at this fantastically low price: Receiver complete with 6 tubes; transmitter complete with 4 tubes, Dynamotor for 24 V DC operation, 5 coil sets, 2 control boxes, antenna switching relay, operating manual. ALL BRAND NEW—and All Yours, for only. . . . . **\$15.95**

**TS-161APN TEST SET**  
 Very Special at this low price. BRAND NEW. Complete with all cables. . . . . **\$12.95**

**Type 2J1F1 SELSYNS**  
 Operates from 57 1/2 volts, 400 cycles. New tested. Conversion diagram for 110 volts AC included. BRAND NEW, each. . . . . **\$2.95**  
 CAPS FOR ABOVE. . . . . .50c

**TYPE APN/1 ALTIMETER**  
 Complete with all tubes. Limited quantity at this special low price! **\$8.95**

**NAVY RECEIVER TYPE ARB**  
 Four Band, 105 to 9050 kc. Low Freq., Ship, Broadcast—40 to 80 meters. Includes tubes and dynamotor, for 24 volt operation. Easily converted for 110 V., 12 V. or 6 V. Schematic included. Excellent Condition. Overall: 8 3/4" x 7 1/4" x 15 1/4". Wt. 30 lbs.  
**COMPLETE WITH ALL TUBES, Special. . . . . \$21.50**

**EE-8 FIELD PHONES**  
 Talk as far as 17 miles! Dependable 2-way communication at low cost! Ideal for home, farm, field. Up to six phones can be used on one line. Each phone complete with finger. Originally cost govt. \$65.00 each. Excellent condition.  
**OUR PRICE, EACH. . . . . \$16.66**



**2-VOLT BATTERY "PACKAGE!"**  
 1—2V. 20 Amp. Hr. Willard Storage Battery. . . . . **\$2.45**  
 1—2V. 7 prong Synchronous Plug-in Vibrator. . . . . **1.49**  
 1—Quart Bottle Electrolyte (for 2 cells) . . . . . **1.45**  
**ALL BRAND NEW!**  
 Combination Price. . . . . **\$4.99**

**Willard 6-Volt Midget Storage Battery**  
 3 Amp. Hour. BRAND NEW. 3 3/8" x 1-13/16" x 2 3/8". Uses Standard Electrolyte. . . . . Only **\$2.22**

**WRITE FOR FREE CATALOG!**  
 Please include 25% deposit with order—Balance C.O.D. MINIMUM ORDER \$30.00. All Shipments F.O.B. Our Warehouse N.Y.C.

**G & G Radio Supply Co.**  
 Dept. N-7  
 51 Vesey St., New York 7, N. Y., CO 7-4605

## BC-946B BROADCAST RECEIVER



520 to 1500 Kc. 6 tubes: 3—12SK7, 12SR7, 12A6, 12K8. For dynamotor operation. Easily converted to 110 or 32 volt. 2-1/2 stages, 3-gang tuning cond. BRAND NEW, sealed carton, with tubes, manual, less dynamotor. **\$19.95**

BC-457 TRANSMITTER—4-5.3 Mc. Complete with all tubes and crystal. BRAND NEW. . . . . **\$8.95**  
 BC-458 TRANSMITTER—5.3 to 7 Mc. Complete with all tubes and crystal. BRAND NEW. . . . . **\$7.95**  
 BC-459 TRANSMITTER—7-9.1 Mc. Complete with all tubes and crystal. BRAND NEW. . . . . **\$11.95**

**SCR-274 COMMAND EQUIPMENT**  
 ALL COMPLETE WITH TUBES

Type	Description	Used	Excellent Used	BRAND NEW
BC-453	Receiver 190-550 Kc.	\$9.95	\$11.95	\$14.95
BC-454	Receiver 3-6 Mc.	7.19	8.29	11.95
BC-455	Receiver 6-9 Mc.	5.25	7.95	9.95
BC-456	Modulator	2.24	2.75	4.24
BC-450	3-Receiver Control Box	1.49	1.95	
BC-451	Transmitter (control Box)	1.25	1.49	
BC-696	Xmtr 3-4 Mc (like new)		7.95	10.95

**110 VOLT AC POWER SUPPLY KIT**  
 FOR ALL 274-N RECEIVERS  
 Can be assembled quickly and easily. Plugs into the rear of any model 274-N receiver and delivers 24 volts as well as "B" voltage. No wiring changes needed. Complete kit of parts with metal case, instructions. . . . . **\$7.95**

**SPLINED TUNING KNOB FOR 274-N RECEIVERS.** Fits BC-453, BC-454 and others. Only. . . . . **4.95**

**ARC-5/R-28 RECEIVER**  
 2 Meter superhet, 100 to 156 Mc in 4 xtal channels. Louvred alum. cabinet 7 3/8 x 4 7/8 x 1 1/4". Complete with 10 tubes and 4 xtals. . . . . **\$14.95**  
 Excel. Cond. . . . .

**ARC-5/T-23 TRANSMITTER**  
 Companion for above, incl. 2-832A, 2-1625 tubes and 4 xtals. . . . . **\$14.95**  
 Less Tubes. . . . . **\$6.95**

**ARC-5 MARINE RECEIVER-TRANSMITTER**  
 Navy Type Comm. Receiver 1.5 to 3 Mc. BRAND NEW with 6 tubes. . . . . **\$16.95**  
 Navy Type Comm. Transmitter 2.1-5 Mc. BRAND NEW with 4 tubes and Xtal. . . . . **\$12.45**

**SCR-522 FINEST 2-METER RIG!**  
 Terrific buy! VHY Transmitter-Receiver, complete with all components, 100-156 Mc. 4 channels. Xtal-controlled. Amplitude modulated voice. They're going fast! Excellent condition.  
 SCR-522 Transmitter-Receiver, complete with all 18 tubes. COMBINATION. . . . . Special **\$33.33**  
 Receiver Only, with all tubes. . . . . **\$19.50**  
 Transmitter Only, with all tubes. . . . . **\$22.25**



## LORAN APN-4 FINE QUALITY NAVIGATIONAL EQUIPMENT

Determine exact geographic position of your boat or plane! Complete, BRAND NEW installation consists of: ID-6B/APN-4 Indicator; R-9B/APN-4 Receiver; PE-206 Inverter; Set of Plugs; Visor for Indicator; Operation manual; Brand New, Export **\$129.50**  
**Packed. COMPLETE**  
 R65/APN-9 LORAN Receiver-Indicator, complete with tubes and operating manual, **\$295.00**  
 BRAND NEW, export packed.

**SPECIAL APN-9A LORAN Receiver Indicator,** less tubes, NEW (demilitarized) . . . . . **\$29.50**

**BC1206-C BEACON RECEIVER**  
 195 to 420 Kc. made by Setchell-Carlson. Works on 24-28 volts DC. 135 Kc. IF. Complete with 5 tubes. Size 4" x 4" x 6". Wt. 4 lbs. BRAND NEW. **\$8.88**  
 Brand New, less tubes. . . . . \$5.95  
 BRAND NEW, less tubes. . . . . **\$5.95**  
 USED, with tubes. . . . . **5.95**  
 USED, less tubes. . . . . **2.95**

**BC-221 FREQ. METER**  
 Limited quantity, first come first served! Range 125 to 20,000 Kc with crystal check points in all ranges. Complete with tubes, crystal, calibration charts. Excellent condition. **\$111.11**

**BC-221 FREQ. METER CASE**  
 Aluminum case for BC-221 or TS-164 Freq. Meters. With volt. reg. supply using VR105, 2 ballast tubes, relay, cable, etc. Inside front: 9 3/4 x 7 1/2 x 7 3/8". Inside rear: 2" deep. Shock-mounted.  
**BRAND NEW,** (Add 50c for packing) **\$3.99**

Original Crystal for BC-221  
 1000 Kc BRAND NEW. . . . . **\$8.45**  
**COMPLETE OPERATING MANUAL** for BC-221 Freq. Meter. . . . . **\$1.95**

**BC-442 ANTENNA RELAY UNIT**  
 Wonderful Value! Consists of 3/4 amp 2 1/2 RF Ammeter (antenna current indicator), 0-10 scale, Transmitter-Receiver Switching relay, in aluminum case with associated components. BRAND NEW. . . . . **\$2.24**



The New  
**GOODMANS**



plus  
**YOUR LOUDSPEAKER**

plus  
**A SIMPLE ENCLOSURE**  
only two-thirds the size required  
for a bass reflex



will give you  
**IMPROVED**  
**SPEAKER SYSTEM**  
**PERFORMANCE...**  
through 'Friction Loading'

- Extended bass response to 20 cycles
- Virtually no peaks above this frequency
- Effective air-loading to zero cycles — greatly reducing distortion due to excessive cone displacement

See your hi-fi dealer, or write for complete details to Dept. RG-5

**ROCKBAR CORPORATION**  
650 Halstead Avenue, Mamaroneck, N. Y.

In Canada: A. C. Simmonds & Sons, Ltd., Toronto, Can.



**TAPE TIMING CHART**

Reeves Soundcraft Corp., 10 East 52nd Street, New York 22, New York has added a timing chart to its line of audio accessories.

The need for a timing chart has become increasingly apparent because of the confusion that has developed through the introduction of long-play and extra-long-play recording tapes.

The chart enables the user to determine at a glance the time and length factors used in tape recording. Because the chart is semi-logarithmic, it is exceedingly accurate in determining the length and time factors for short commercial and spot announcements.

The company's dealers are handling this item which sells for \$1.20.

**G-E COAX SPEAKER**

The General Electric Company is now marketing a 12-inch dual coaxial high-fidelity loudspeaker which has been designated as the "Golden Co-Ax" Model A1-401.

The speaker is rated at 25 watts and provides smooth response from 40 to 15,000 cps. The unit consists of a 12"



woofer and a 2 3/4" tweeter with a built-in crossover network. The specially-designed slotted baffle plate serves as a baffle for the tweeter and a low-pass filter which reduces interference between the woofer and tweeter waves. The baffle plate is finished in gold so that the speaker can be front-mounted without covering.

A data sheet on the "Golden Co-Ax" is available from the company's audio department at Syracuse, New York or from the firm's sound distributors.

**NEW SHURE ITEMS**

Shure Brothers, Inc., 222 Hartrey Ave., Evanston, Illinois has added two new items to its line of audio components.

The Model "535 Slendyne" micro-

phone is of the dynamic type. It can be used in the hand, on a floor stand, on a desk stand, or hung around the neck on a lavalier cord and clip assembly. The mike also has an "on-off" switch adapter and a dual-impedance switch to provide a versatile, rugged unit.

The second item is a replacement cartridge kit, the RK56. The three cartridges in the kit provide dependable, quickly installed replacements for 217 cartridges of seven manufacturers. The kit includes a Model MC10, a Model W70, and a Model W72.

**"ACOUSTIC GATE" MICROPHONE**

Altec Lansing Corp., 9356 Santa Monica Boulevard, Beverly Hills, California is now marketing a new dynamic microphone for broadcast or p.a. use which incorporates the firm's unique "Acoustic Gate" principle.

A peripheral sound entrance channel of 2 mil width, the "Acoustic Gate" provides an acoustical resistance loading, virtually independent of frequency to the front of the diaphragm, thereby eliminating high-frequency peaks and extending the smooth frequency response over an exceptionally wide range. This design also lessens the effects of wind, water, dirt, or weather and allows the microphone to be used under adverse conditions.

Write Dept. RV-6 of the company for full details and specifications.

**CERAMIC CARTRIDGE LINE**

Sonotone Corporation, Elmsford, New York is currently marketing a new line of ceramic phonograph cartridges which has been designated as the "3" series.

One of the units in the line is the "3T," a turnover type which plays records at all speeds. Diamond needles are recommended to insure the full benefits of the performance character-



istics of the cartridge, although the unit is also available with sapphire needles if desired.

The color scheme is jet black and gold. Since this entire line is of the

ceramic type, equalizers and preamplifiers are not required.

**"HI-FI TECHNIQUE"**

M. A. Miller Manufacturing Co., 4th & Church Streets, Libertyville, Ill. has introduced a new product designed to clean records and keep them static free.

Tradenamed "Hi-Fi Technique," the product consists of a two-step operation involving the use of a special cellulose sponge and an anti-static lubricant. The lubricant is in spray form



and is applied in a fine mist over the record after the record has been washed with the special sponge.

The product is being marketed as a package with the aerosol can and sponge packed together in a polyethylene pouch.

Address requests for further information on this product to the sales manager of the company, Leroy W. Mintz.

**PORTABLE DISC RECORDER**

A new portable disc recorder and playback reproducer, known as the "Imperial," has been introduced by Rek-O-Kut Company, 38-01 Queens Blvd., Long Island City 1, New York.

This deluxe model features a newly-designed overhead cutting lathe with interchangeable leadscrews and with provision for making run-in and run-



off grooves. It is also calibrated for timing.

Another new feature of the "Imperial" is the new cutting head having a recording range from 50 to 10,000 cps. A tone arm for records up to 16" is included with a dual-sapphire G-E variable reluctance cartridge.

The amplifier serves for both re-

July, 1956

**Having trouble with**

**AGC**

or

**SWEEP**

**systems?**



**"Servicing AGC Systems"**

by Henry A. Carter and Thomas A. Lesh

This practical book describes in detail the operation of the various types of Automatic Gain Control systems used in commercial TV receivers. Provides a clear explanation of AGC circuitry and describes the best servicing techniques to be applied toward finding and correcting AGC troubles. Symptoms of AGC troubles are shown in actual photographs as they show up on the picture tube. An invaluable book for TV Service Technicians. 132 pages; fully illustrated; 5 1/2 x 8 1/2". \$1.75 Order today; postpaid only



**"Servicing TV Sweep Systems"**

by Jesse Dines

Describes the operation, circuit function and circuit variation of the different types of vertical and horizontal sweep systems common to most TV receivers. Describes best methods for analyzing circuits and for troubleshooting the vertical and horizontal sweep systems; fully supported by helpful photographs, waveforms and service hints covering specific troubles. Also discusses construction of sweep transformers, coils and deflection yokes. 212p., 5 1/2 x 8 1/2"; fully illustrated. Postpaid, only \$2.75

USE HANDY ORDER FORM BELOW

Sams books cover every phase of Electronics for the service technician, engineer, student or experimenter. Listed below are a few of the many valuable Sams books available at electronic parts distributors and leading book stores.

**SAMS BOOKS**  
keep you ahead in  
**ELECTRONICS**

**USE THIS ORDER FORM**

**SERVICING AGC SYSTEMS.....\$1.75**

**SERVICING TV SWEEP SYSTEMS.....\$2.75**

- Color TV Training Manual.** Prepares the Technician for Color TV service work. Covers principles of the Color TV system; Color receiver circuits; installation and servicing sets. Includes color blocks outlining the use of color test equipment. 260 pages; 8 1/2 x 11"; 300 illustrations. \$6.95
- TV Test Instruments.** Revised and enlarged to include latest data on instruments used in Color TV servicing. Tells clearly how to operate each type of test instrument used in TV service work. 180 pages; 8 1/2 x 11"; illustrated..... \$3.50
- Key Checkpoints in TV Receivers.** Prepared by the Howard W. Sams engineering staff. Provides many applications for general TV service work, including time-saving information on how to make quick tests at key points to determine where trouble lies, and how to check overall performance of the receiver after repair, to insure against callbacks. 182 pages; 5 1/2 x 8 1/2"; illustrated..... \$2.00
- Analyzing and Tracing TV Circuits.** Presents a new approach to TV servicing. 168 pages. 8 1/2 x 11"..... \$3.00
- Photofact Television Course.** Gives a clear complete understanding of TV principles, operation, practice. Used by thousands of students. 208 pages, 8 1/2 x 11"..... \$3.00
- Radio Receiver Servicing.** Covers the basic receiver types—gives time-saving hints for solving basic troubles, such as dead set, weak set, noisy set, etc. 192 pages; 5 1/2 x 8 1/2"..... \$2.50
- Technical Dictionary.** Over 4,000 definitions of radio, television, electronic, electrical and radar terms. Includes valuable charts, graphs, diagrams and symbols. Flexible binding for "on-the-job" use. 160 pages; 5 1/2 x 8 1/2"..... \$2.00

- Tape Recorders—How They Work.** Explains recording theory, tape characteristics, motorboard mechanisms, drive motors, amplifiers, magnetic heads, volume indicators, equalization circuits—covers everything you want to know about recorders. 176 pages; 5 1/2 x 8 1/2". \$2.75
- The Recording and Reproduction of Sound.** Oliver Read's best-seller on audio and Hi-Fi. Covers theory of sound, basic recording methods, phono reproducers, amplifiers, speakers and enclosures, attenuators and mixers, tuners, home music and P.A. systems. 810 pages; 6 x 9"..... \$7.95
- Transistors—Their Application in Television-Radio-Electronics.** The first practical, complete book on transistors; explains circuitry, installation, testing techniques, theory and servicing. 100 pages; 5 1/2 x 8 1/2" illustrated..... \$1.50
- So You Want to Be a Ham.** Tells you what you need to know about getting your license and acquiring equipment. Covers such subjects as: Conquering the Code; Getting Your Ticket; Going on the Air; Electronics as a Career; etc. 196 pages; 5 1/2 x 8 1/2"; illustrated..... \$2.50
- Principles & Practices of Telecasting Operations.** Discusses equipment and techniques. Covers such subjects as: TV Cameras; Control Rooms; Fundamentals of Studio Lighting; Relay Systems; Maintenance Practices; Technical Production; etc. 600 pages; 6 x 9"; illustrated..... \$7.95

There is an authoritative Sams book on virtually any Electronic subject in which you're interested. Check below for FREE Book List describing all Sams books.

Send Book List



**HOWARD W. SAMS & CO., INC.**

Order from your Parts Jobber today, or mail to Howard W. Sams & Co., Inc., Dept. 1-G6, 2201 East 46th St., Indianapolis 5, Indiana.

Send books checked above. My (check) (money order) for \$..... is enclosed.

Name.....

Address.....

City..... Zone..... State.....

(outside U.S.A. priced slightly higher)

Look for  
**SAMS BOOKS**  
on the  
"Book Tree"  
at your Parts  
Distributor

# AMERICA'S GREATEST TUNER BUY!

The Sensational

## Granco FM TUNER



Amazing Value... **\$34<sup>95</sup>\*** in walnut

Compare its performance with high priced tuners  
**PROVIDES ENDLESS HOURS OF STATIC-FREE  
AND DRIFT-FREE FM LISTENING PLEASURE**

The perfect addition to any HI-FI system,  
TV set, phonograph or tape recorder!

- Model T-160
- Frequency Range: 88-108 Mc.
  - Selectivity: 200 Kc at 3 db points.
  - Audio Frequency Response: 20 cps to 20,000 cps.
  - Sensitivity: 4 microvolts for 20 db quieting.
  - Coaxial Tuner: Exclusive Granco feature assures drift-free reception.
  - Hum Level: 70 db below 1 volt.
  - Maximum Audio Output: 2 volts.
  - Antenna Input: 300 ohms or built-in line cord antenna.
  - Overall Dimensions: 7" w. x 5" h. x 4 3/4" d.

**ASK YOUR DEALER FOR A DEMONSTRATION**

See and hear Granco's FM and FM-AM table radios  
and high fidelity radio-phonograph combinations

\*Price slightly higher  
in West and South

for name of your nearest dealer, write

**GRANCO PRODUCTS, INC.**

36-07 20th Ave., Long Island City 5, N. Y.

World's only manufacturer specializing in FM

recording and playback and has high level and low level inputs for recording live, from tape, off-the-air, or from other record discs. A recording level meter is mounted on the control panel which also includes volume, level, and mixing controls.

Write Avery Yudin, sales manager of the company, for full details, prices, and specifications.

### "MAGNELOOP"

Amplifier Corporation of America, 398 Broadway, New York 13, New York has developed and is now marketing an entirely new tape drive system for its continuous loop magnetic tape recorder.

The new unit permits the stepless control of tape speeds from 1 1/2 to 15

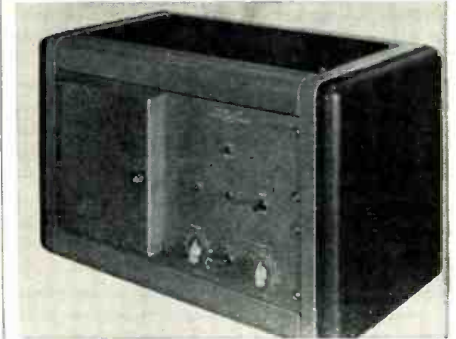

ips with a frequency response of 50 to 15,000 cps at the higher speed. Continuously variable automatic equalization and amplitude compensation are incorporated. Unusual recording and playback possibilities are created because speed control over an 8 to 1 ratio is now possible on a single unit.

Recorders, reproducers, or recorder-reproducers are available in single, dual, and triple channel models each incorporating a shock-mounted ruggedized low-noise-level preamp. a 100 kc. ultrasonic bias and erase oscillator, and an efficient d.c. motor.

Write the manufacturer for complete information on this new "Magne-loop" series.

### FOUR-SPEAKER P.A. SYSTEM

Newcomb Audio Products Co., 6824 Lexington Avenue, Hollywood, California has added a four-speaker combina-



tion transcription player-public address system to its line of portable equipment for use in large halls, gyms, and out of doors.

The TR-25AM-4 unit assembles into three portable carrying cases. Four 12-inch Alnico V PM speakers are capable of covering any room size with hi-fi sound from records or microphones. The new equipment has a 25-watt amplifier with frequency response (Continued on page 113)

RADIO & TELEVISION NEWS

### All Tubes Unconditionally Guaranteed For 1 Year

PRETESTED TUBES			INDIVIDUALLY BOXED		
OZ4	6AC7	6BK5	6SK7GT	12AL5	12507
1B3GT	6AG5	6BK7	6SL7GT	12A77	12SR7
1H5GT	6AG7	6BL7GT	6SN7GT	12A06	19BQ6G
1LC5	6AF4	6BQ6GT	6SQ7	12A07	25BQ6GT
1LN5	6AK5	6BQ7	6SR7	12A06	25L6GT
1N5GT	6AL5	6BY5G	6T8	12AV7	25W4GT
1Q5GT	6A05	6BZ7	6U8	12AX7	25Z6GT
1R5	6A55	6C4	6V3	12AX4GT	25Z5
1S4	6AT6	6CB6	6V6GT	12AX7	25Z6GT
1S5	6A06	6CD6G	6W4GT	12BA6	35E5
1T4	6A06	6CF6	6W6GT	12BE6	35C5
1T5GT	6AUSGT	6F6	6X4	12AZ7	35L6GT
1U4	6AV5	6H6GT	6X5GT	12BH7	35W4
1U5	6AV6	6J5GT	6Y6G	12BY7	35Y4
1X2	6AX4GT	6J6	6Y6G	12SA7	35Z5GT
3Q4	6AT6	6K6GT	7C5	12S7	50A5
3S4	6AH4GT	6L6	7C6	12S7GT	50B5
3V4	6BA6	6S4	7E7	12SK7	50C5
5U4G	6BC5	6SB7	7F7	12SL7GT	50L6GT
5V4G	6BE6	6SA7	7F7	12SN7GT	117Z3
5Y3	6BGGG	6SH7	7F8		
6AB4	6BJ6	6SJ7GT	7N7		

Now Get Up to \$5 For Your Old TV Tube!



upon the purchase of a  
**BRAND NEW  
DUMONT or RCA lic.  
PICTURE TUBE**

Ship dud prepaid... If you supply dud, deduct from the list prices as follows:

10"-14"-\$2 | 15"-\$2.50 | 16"-17"-\$3.50 | 19"-\$4 | 20"-\$4.50 | 21"-\$5

Prices indicated below are without trade-in.

10BP4	\$10.95	15DP4	\$16.95	16RP4	\$17.00	19AP4	\$23.00
12LP4	12.95	16DP4	18.50	17PB4	19.00	20CP4	24.00
12QP4	12.95	16GP4	18.95	17GP4	21.00	21ALP4A	24.00
14CP4	14.95	16KP4	17.00	17LP4	18.00	21EP4	24.00

Picture Tubes Shipped F.O.B. Passaic, N. J.  
Shipped Via Railway Express Dept. MR-7 PRescott 3-0330

# TUBE MART

The Lokpet Bldg. Passaic, N. J.

**NEW QUICK  
24 HOUR  
SERVICE  
AVAILABLE!**

ANY  
ASSORTMENT  
RECEIVING  
**TUBES**

**41c**  
ea.

Quantity Buyers!

100 Tubes — \$38.00

FREE POSTAGE on all prepaid Continental U. S. A. orders. 25c handling charge on all orders under \$5.00. 25% Deposit on all C.O.D.'s. Subject to prior sale. Write for FREE TUBE LIST!



"Okay! Okay! I know it's powerful, but I don't need one."

## Special



### DYNAMOTOR

Brand new, government surplus. 12 VDC input. 440 VDC, 400 ma output. Can be filtered with 2 mfd paper condenser. Starting relay not included. Has snap-on mounting plate with Jones S-412-AB socket for input and output leads. Size 5 3/4"Hx4 1/2"Dx9"W, and weighs 13 1/2 lbs. Net.....\$ 14.95

Don't get yourself in a whirl thinking about how you can pay for that new ham gear you have been dreaming about. Your used (factory-built) communications and test equipment, plus a Walter Ashe "Surprise" trade-in allowance, will go a long way toward making your dream come true. Here is how - just tell us what used equipment you have to trade and what new gear you want. Our liberal, money-saving "Surprise" trade-in allowance will more than please you. Get your trade-in deal working today. Wire, write, phone, or use the handy coupon.



**MULTI-ELMAC TRANS-CITER MODEL AF-67.** Net.....\$ 177.00



**VIKING "PACEMAKER"**

New transmitter for SSB, AM, and CW. Built-in VFO. Wired and tested. Net.....\$ 495.00



**MULTI-ELMAC PMR-7 MOBILE RECEIVER.** Less Power Supply. Net.....\$ 159.00



**GONSET G-66 RECEIVER.** Less power supply and speaker. Net.....\$ 169.50  
Power Supply. 6-12VDC-115VAC. Built-in speaker. Net.....\$ 39.95



**MORROW MOBILE RECEIVER MODEL MBR-5.** 80 thru 10 meters. Dual conversion. 13 tubes. Less power supply and speaker. Net..\$ 224.50

**PSR-612 POWER SUPPLY.** 6-12 VDC. Net.....\$ 34.00

All prices f. o. b. St. Louis • Phone CHestnut 1-1125

WRITE FOR FULL INFORMATION ABOUT OUR TIME PAYMENT PLAN

**Walter Ashe**  
**RADIO CO.**  
1125 PINE ST. • ST. LOUIS 1, MO.  
*Our 34th Year*

WALTER ASHE RADIO COMPANY  
1125 Pine Street, St. Louis, Mo. RN-7-56

Rush "Surprise" Trade-In Offer on my.....  
for.....  
(show make and model of new equipment desired)

Rush FREE 1956 Walter Ashe catalog.

Name.....  
Address.....  
City..... Zone..... State.....

# FREE 1956 CATALOG

## WORLD RADIO LABORATORIES

"The World's Largest Distributor of Amateur Radio Equipment"

Jam packed with bargains — everything in Radio, TV, and Hi-Fi — for Handyman, Ham, Experimenter or Serviceman!

- Pay Only 10% Down
- Easy Terms
- Liberal Trade-Ins
- Save Over 50% on Recond. Eqpt.
- Over 800 Guaranteed Recond. Items



### WORLD RADIO LABORATORIES

3415 WEST BROADWAY  
COUNCIL BLUFFS, IOWA



Leo I. Meyerson

PERSONALIZED SERVICE

### MAIL HANDY COUPON

WORLD RADIO LABORATORIES, INC. R-7  
3415 W. Broadway — Council Bluffs, Iowa

Free 1956 Catalog  New Beam Manual  
 Wall-Sized Radio Map 25c

NAME \_\_\_\_\_  
ADDRESS \_\_\_\_\_  
CITY \_\_\_\_\_ STATE \_\_\_\_\_



## WANTED

Willing to pay cash for Early Phonographs with outside horns

WANT Coronet (illustrated), Double Bell Wonder, Victor Types A, D, E, and O, Monarch Special and Improved Monarch. Also Edison Tin-foil (replica) machine, his Idelia, Excelsior, and Treadle Phonographs. Want early Bell-Tainter. American Gramophones, Multi-Phone, Multinola, Scott Magazine Phonograph, Peerless, Sovereign, Wizard Phonograph, Regina Hexaphone, and Graphophones. Also catalogues or old literature on phonos made prior to 1906. Want unusual machines and coin-in-slot cylinder phonographs. Need a few early reproducers (sound boxes) for Victor, Columbia, and Edison.

A few duplicate Edisons and graphophones are now available for sale or trade.

Send clear snapshot and full information to  
Box 50  
RADIO & TELEVISION NEWS  
366 Madison Ave., New York 17, N. Y.

## Repairing Portables (Continued from page 51)

is obtained from the same source as the "B+." The critical filament voltage of the 1R5 converter has already been treated. Its contribution to oscillator instability is aggravated by lowered "B+" from an old selenium rectifier or old filter capacitors that have developed leakage.

The "B+" power supply and filament circuits of a typical 3-way portable are shown in Fig. 6. The change-over switch from battery to power line operation has been omitted for the sake of clarity.

The first test on such a power supply should be a voltage check at the junction of  $R_{14}$  and  $R_{15}$ —the output of the rectifier. If the voltage is low, then the rectifier is bad, or the filter capacitors are low in capacity or have excess leakage (assuming the absence of a shorted tube or component).

Rectifier  $SE_1$  can be checked by shunting it with another test rectifier as indicated in Fig. 6. Observe proper polarity. The output voltage (junction  $R_{14}$ ,  $R_{15}$ ) will rise irrespective of whether the selenium in the circuit is good or bad. If the amount of rise is 5% or less (about 5 to 6 volts) then the rectifier is good. If the rise is more than this percentage, then the selenium is bad regardless of resistance checks on it. The bridging test is far more conclusive than testing the forward and the back resistance with an ohmmeter. Be sure to use a test rectifier with the same rating as the one in the set—do not use one appreciably different in rating or the test will not furnish the desired information.

If the rectifier is OK or has been replaced and the "B+" voltage is still low, try bridging the input filter capacitor ( $C_{23}$ , 40  $\mu$ fd., in Fig. 6). In the absence of short circuits, this will bring the input voltage up to par. Do not use a capacity appreciably greater than that of the unit being bridged. The surge may blow the weakest tube in the filament string.

Failure of the filament filter capacitor  $C_{23}$  will permit audio current to travel to the 1st audio, i.e., and con-

verter stages. The result may be motor-boating and assorted "burps" and squeals.

If shunting the filament filter capacitor ( $C_{23}$ ) eliminates the symptom, then it is defective. This is test point "T3."

This capacitor can have high leakage and rob the other tubes of enough filament current so that trouble such as oscillator failure or 3V4 burnout may develop. The same is true of capacitors  $C_{20}$  and  $C_{21}$ . A positive test for this condition is to disconnect the suspected capacitor. If the filament voltage rises, the capacitor should be replaced. Do not rely on an ohmmeter measurement of leakage unless the indicated leakage is definitely out of line. Also, do not use a very low range of the ohmmeter in testing this circuit "cold," tubes can be blown easily here!

An increase in value of the shunting resistors  $R_{10}$  and  $R_{11}$  will permit an excess of current to flow through the tubes to the ground side of the filament string. Premature burnout may result. When checking with an ohmmeter, remove the tubes.

Opening of the second "B+" filter capacitor ( $C_{18}$ , 40  $\mu$ fd.) may result in whistles and high-pitched squeals plus hum. There will also be a slight lowering of "B+" at both test points "T2" and "T1," since this capacitor helps  $C_{23}$  hold up the d.c. voltage at "T1," the rectifier output. Shunt with a test capacitor to check for low capacity. Disconnect the capacitor and observe the d.c. voltage as a test for excess leakage; the d.c. voltage will rise appreciably if  $C_{18}$  is defective.

Numerous modern portable radios employ a printed circuit for audio coupling—a "Couplate" or similar unit. With a defective component in such a circuit, it is advisable to replace the entire unit rather than endeavor to shunt the defective component with another or make a similar type repair. The danger is that the original part (capacitor, resistor, etc.) left in the "Couplate" may change its value or connect itself back into the circuit. The result may be instability in one form or another.

Take care in testing these "Couplates" since they may crack and the damage may be latent only to show up at some subsequent date.

-30-

Fig. 6. Schematic diagram of the basic power supply circuit of an Emerson portable.

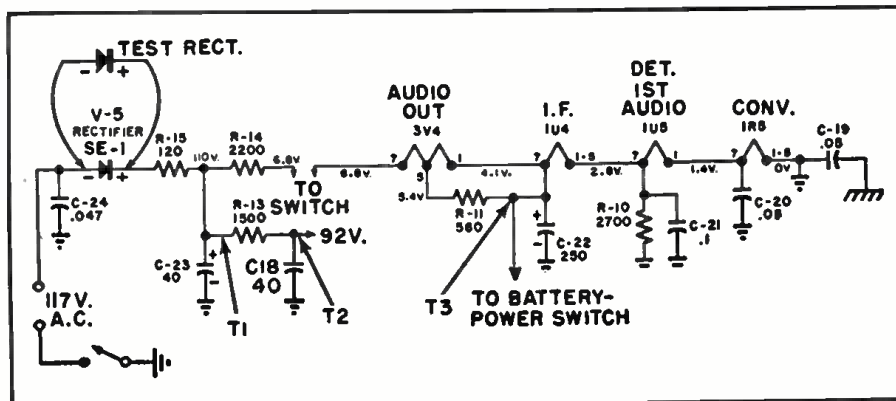

# ALLIED knight-kits

**FINEST ELECTRONIC EQUIPMENT  
IN LOWEST-COST KIT FORM**

- ★ Latest Advanced Design ★ Quality Components  
★ Easiest to Assemble ★ Save Up To 50%

**BUY DIRECT...YOU SAVE MORE**

**free 1956 CATALOG**

Send for it! Describes the famous KNIGHT-KITS in detail—shows you how you can easily assemble your own instruments and get performance and appearance equal to equipment selling for several times the KNIGHT-KIT price. The 324-page ALLIED Catalog is the leading buying guide to everything in Electronics—write for your copy.



**SAVE ON THESE QUALITY knight-kit TEST INSTRUMENTS**

5" Wide-Band Oscilloscope Kit F-144 69.00	Printed Circuit VTVM Kit F-125 24.95	Tube Tester Kit F-143 counter type 29.75 F-142 portable type 34.75	VOM Kit 1000 Ohms/Volt F-128 15.95	VOM Kit 20,000 Ohms/Volt F-140 28.50	In-Circuit Capacitor Checker Kit F-119 11.65
Audio Generator Kit F-137 31.50	Resistance-Capacitance Tester Kit F-124 18.75	High-Gain Signal Tracer Kit F-135 23.75	RF Signal Generator Kit F-145 19.75	Resistance Substitution Box Kit F-139 5.95	Capacitance Substitution Box Kit F-138 5.50

**FAMOUS knight-kits FOR THE HOBBYIST**

"Space Spanner" 2-Band Receiver Kit S-243 13.95 S-247 cabinet, 2.85	"10-in-1" Lab Kit S-285 12.45	"Ranger" Superhet Receiver Kit S-735 14.85
"Ocean Hopper" Receiver Kit S-740 10.75	Transistor Radio Kit S-765 3.95	Geiger Counter Kit S-242 15.95
3-Way Portable Radio Kit S-730 19.95	Photoflash Kit S-244 28.50 S-246 AC supply, 3.40	Wireless Broadcaster Kit S-705 8.75

**TOP QUALITY HIGH FIDELITY knight-kits**

Basic 25-Watt Deluxe Amplifier Kit S-755 41.50	10-Watt Hi-Fi Amplifier Kit S-234 22.95	20-Watt Hi-Fi Amplifier Kit S-750 35.75

**LOW-COST knight-kits FOR THE AMATEUR**

50-Watt CW Transmitter Kit S-255 42.50	Self-Powered VFO Kit S-725 27.50	Code Practice Oscillator Kit S-239 3.95

**FREE** Send for the 324-page ALLIED Catalog describing all KNIGHT-KITS—and your buying guide to everything in Electronics.

**ALLIED RADIO CORP., Dept. 1-G-6  
100 N. Western Ave., Chicago 80, Ill.**

Please ship the following Knight-Kits: \_\_\_\_\_

My check , money order  for \$..... enclosed.  
 Please send FREE 1956 Catalog.

Name \_\_\_\_\_  
Address \_\_\_\_\_  
City \_\_\_\_\_ Zone \_\_\_\_\_ State \_\_\_\_\_

All Prices Net F.O.B. Chicago  
**ORDER FROM**

**ALLIED RADIO**  
100 N. Western Ave., Chicago 80, Ill.

July, 1956

# A New Radiation Counter

Over-all view of the radiation counter. The coil cord on the probe prevents unnecessary tangling of leads.



*Operational details on a recently introduced Geiger counter unit which provides "professional" results at moderate cost.*

**D**ESIGNED for the serious uranium prospector, the new *Heath RC-1* radiation counter incorporates many of the features normally found only in the expensive, extremely sensitive units used by professionals.

The circuit employs a prewired, high-voltage supply with a four-tube amplifier and pulse shaper. A 4½ inch meter, calibrated in counts-per-minute, gives full-scale readings from 100 to 60,000 cpm. In addition, the meter is calibrated in milliroentgens per hour from .02 to 10 mr/hr. full scale.

A glance at the circuit diagram be-

low will show that loudspeaker indication has been incorporated in addition to the meter. The circuit is excited by a transistor oscillator which provides a pleasant tone for monitoring. A panel control cuts out the loudspeaker circuit as desired.

The counter incorporates four "cpm" ranges: 0-100, 600, 6000, and 60,000 and four milliroentgen ranges: 0-.02, .1, 1, and 10. The time constant of the circuit can be adjusted from .5 to 10 seconds in steps of .5, 1, 5, and 10 seconds.

The probe, which houses the 6306

bismuth counter tube, is of satin aluminum and chrome-plated steel. A coiled cord between the probe and the instrument helps to prevent tangling.

The unit is powered by one 67½ volt "B" battery and two 1½ volt "A" batteries. The "B" battery lasts approximately 200 hours in intermittent operation while the "A" batteries should last about 20 hours under the same operating conditions.

The entire instrument is housed in an aluminum cabinet which measures 9½" high, 6½" wide, and 5" deep. The complete unit weighs 6½ pounds. A top-mounted handle facilitates the transportation of the unit.

## How The Counter Works

In the circuit of the RC-1, negative pulses generated in the probe are impressed across the input grid resistor through the .01 μfd. blocking capacitor (see diagram) and are amplified and inverted by  $V_1$ , appearing across the 68,000-ohm plate load resistor.  $V_2$  further amplifies and re-inverts the signal pulses and injects them into the grid of  $V_3$ . The two stages of amplification are so designed to provide a sensitivity of approximately .1 volt and to limit at an input of .25 volt. This design insures a pulse of proper amplitude for triggering  $V_3$ , even though the input pulses may vary considerably in height.

$V_3$  and  $V_4$  together comprise a monostable multivibrator. These two tubes have a common 15,000-ohm cathode resistor which serves as one leg of the coupling impedance necessary for oscillation and also as a source of cut off bias for  $V_4$ . The control grid of  $V_3$  is returned to a positive point on the voltage divider connected between "B+" and ground, causing it to conduct. This conduction causes current flow through the common cathode resistor and the voltage drop across it is sufficient to cut  $V_4$  off, since the grid of  $V_4$  is returned to ground. This makes it possible to use a tube of comparatively large emission capabilities without increasing the "B" battery drain since  $V_4$  doesn't draw current except during the short operating cycle following each input trigger.

The range switch connects various precision capacitors between the plate of  $V_3$  and the grid of  $V_4$  and, in conjunction with the common cathode resistor, provides the necessary cross coupling to enable multivibrator operation. The capacitors switched between the two tubes determine the period of time the multivibrator will remain in its unstable state. This, in turn, determines the average current flowing through the meter.

The aural monitoring circuit features a special 2000-ohm "pitch" control which enables the user to select the tone most pleasing to his ears. This is a front-panel control.

The RC-1 is being offered in kit form for \$79.95 complete with probe, step-by-step assembly instructions, and details on how to use and troubleshoot the instrument.

Complete schematic diagram of the Heath RC-1 radiation counter in kit form.

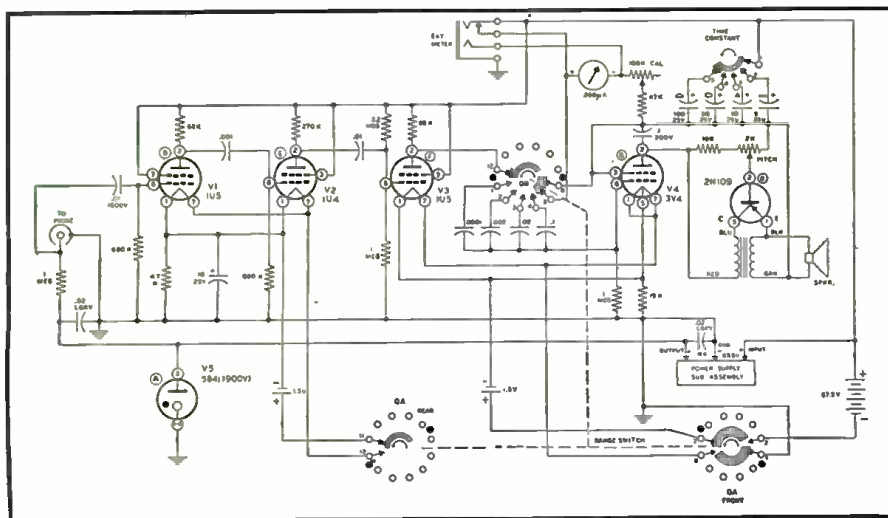



# SUMMER CLEARANCE BARGAINS IN OUTSTANDING SURPLUS ELECTRONICS

## 50 W. 6-CHANNEL RADIOTELEPHONE for BOATS, MOBILE, or FIXED STATIONS



be employed. Operation of the 50 Watt Radiotelephone may be from 12 V. DC. Complete constructional data and diagrams are furnished for building any of the above power supplies at minimum cost. Each set is supplied with 12 crystals (6 for 3-mil. 6 for receive) which were used by the military. Receiving crystals differ 14985 KC (1F frequency). Receiver uses high-efficiency 10 Tube Superhet circuit with RF Stage for maximum selectivity, built-in loudspeaker. Stable Filter (Noise Eliminator) Circuit with Switch, and RF Gain Control. Transmitter uses 8 Tubes (2-807's in Final) with 100% Plate Modulation and Metering Switch with multi-range milliammeter for instant checking of any part of transmitting circuit.

**50-WATT RADIOTELEPHONE (BC-609A, B, or C Models)**, complete with all tubes, crystals (as specified), Inst. Hook, Connecting Cord CD-515 (to Power Supply), Modulation and Power Supply Constructional Data. **USED, GOOD CONDITION.** Shp. wt. 18 1/2 lbs. **\$99.50**

**SAME AS ABOVE, NEW UNUSED CONDITION.** \$139.50

**MODELS BC-669 D or E.** Same as Above, but provides also CW (telegraphy) transmission and reception. **\$169.50**

**INFO: NEW, EACH.** \$169.50

**TS-11 HANDSET**, with appropriate plug connector. **EACH \$14.50**

**THE BIGGEST BARGAIN IN PLEASURE OR FISHING BOAT RADIOTELEPHONES!** Big-power ship-to-shore Radiotelephones. This Transmitter-Receiver (BC-609), part of SCR-5433 is beautifully and ruggedly built. Designed for rough military service and engineered for maximum reliability. Provides true-voice long-range communications from boat, vehicle, portable or fixed station installations. Both Transmitter and Receiver operate in the frequency range of 1685 to 4450 KC, and both are crystal-controlled on all six channels in this range. Manual tuning of the receiver is also provided. Power Output (Phone) is 50 to 60 watts with 12 V. DC Power Supply.

Transmitter operation is performed with a minimum of controls, after installation adjustments have been made. The BC-609 is (1) as approved by FCC for marine band use except on 2738 KC for which frequency a wave trap to eliminate 2nd harmonic radiation must be used.

**CUSTOM BUILT 12 V. DC POWER SUPPLY FOR ABOVE.** EACH \$125.00

**PE-110 A, B, or C, 110 V. AC POWER SUPPLY.** EACH \$89.50

**PE-110 D, 110 V. AC POWER SUPPLY.** EACH \$99.50

**12 V. DC POWER SUPPLY KIT**, complete with transmitting and receiving components, relay, filter, transformer, choke, switches, fuse holders, etc., plus undrilled chassis and wiring diagram. **EACH \$45.00**

**RM-21 REMOTE CONTROL**, Permits transmission & reception (by handset) from remote position. **EACH \$6.95**

## LORAN RECEIVING EQPT., APN-4, AT LOWEST PRICE EVER!!!

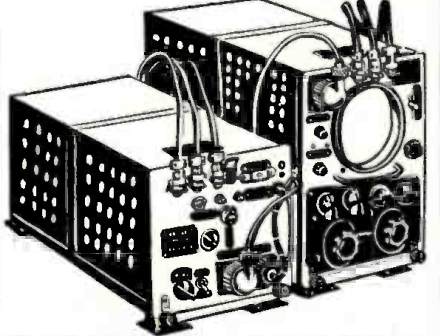

We made a "bug" on this popular model APN-4 Loran unit, used on Fishing and pleasure boats and aircraft for navigational purposes. All are Used but in very clean condition, complete with tubes and crystal. Each set consists of an RD APN-4 Receiver and an ID-6 APN-4 Indicator. Originally sold in surplus for \$100.00 or more per set. It would be wise to buy an extra set for "spare" while available at this real low price! Sorry, no accessories or inverter (80 to 115 V. AC, 400 to 2400 cycles, required) available at this time. Inverters for this equipment are easily available from many surplus houses.

**PRICE PER SET**, each consisting of one Indicator and one Receiver, as shown above. **Excellent—Used.** Shpg. wt. 80 lbs. **\$29.95**

## DELUXE TRANSMITTER FOR HAM OR COMMERCIAL USE AT REAL LOW PRICE!

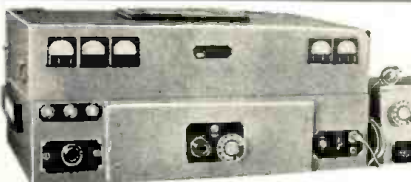

This unit QXC-1100, part of RC-2633 is exceptionally well-built and finely engineered with versatile features. This transmitter is a true transmitter for Ham or Commercial use. Frequency coverage is 1.5 to 10.0 mc; 4-channels of either crystal or VFO control; 2 channels each channel covering the entire 1.5 to 10.0 mc range; Power Output is conservatively rated at 50 W. Phone and is from 100 to 250 W. CW. 25 to 60 channel selection, phone or cw, etc. **REMOTE CONTROL** of all aforementioned operations (transmitter can be in distance) over 2 pairs of wire, and includes a microphone circuit employing a 616 as crystal or VFO oscillator circuit; modulator section has a 615 speech amplifier stage and a 5Z3 low-voltage rectifier; 2-807's as high-voltage rectifier. Additional feature is Pi-Network in Antenna circuit.

**PRICE, EACH, USED—GOOD CONDITION.** \$239.50

**Case of Spare Parts**, includes all meters for transmitter tubes, spare microphone, capacitors, resistors, etc. Shpg. wt. 70 lbs. **\$69.50**

**And Remote Control**, all relays, complete set of tubes, instruction Book, Microphone, export **\$99.50**

75 W. CW, but actual output is 25% more. Operation cycles: Automatic Dialing controls power "on" or "off." (RBI-40) with Automatic Dial permits complete control center, attic, garage, or any remote point up to 11 miles. Amplifier and line level indicating meter. Transmitter, 616 as Buffer-Driver, and 3 807 tubes in RF Power Stage; and 4-616 tubes in power stage. Power Supply section uses a 5Z3 rectifier. Remote Control uses a 615 speech amplifier and a 5Z3 rectifier to reduce harmonic radiation and interference.

**PRICE, BC-100 TRANSMITTER, NEW-UNUSED.** With all tubes, instruction Book, Microphone, export **\$239.50**

**RM-40 REMOTE CONTROL**, for above. Shpg. wt. 75 lbs. **\$69.50**

**Case of Spare Parts**, includes all meters for transmitter tubes, spare microphone, capacitors, resistors, etc. Shpg. wt. 70 lbs. **\$99.50**

## SENSATIONAL BARGAIN!! TCS TRANSMITTERS, RECEIVERS, AND ACCESSORIES

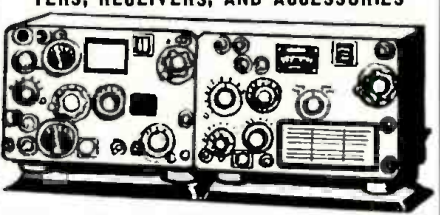

You've never seen TCS Transmitters and Receivers priced so low! This communications "work horse" of the Navy and Coast Guard never sold in surplus for less than \$300 per set (Acq. cost over \$1000.00 per set). It's ideal for mobile or fixed station use: precise, trouble-free, and consistent. Excellent for Maritime Band (2-3 mc) applications if certain front panel controls on Transmitter are removed, after pre-setting of frequencies to meet FCC requirements, and use of QXC requirements regarding second harmonic radiation, since the transmitter uses a Buffer stage, plus (variable) link coupling between the final RF Tank and a Pi-network which couples to the antenna, all of which reduces harmonic radiation to absolute minimum. Other features of TCS Transmitters and Receivers are: complete coverage 1.5 to 12.0 mc all band tuning; 4 channels crystal control, plus one channel manual tuning (in transmitter precision VFO). \* uses 1625 instant heating filament tubes (equivalent to Type 807) in RF Amp and Mod. sections of Transmitter to minimize drain. \* rated at 40 watts CW and 20 watts phone output when transmitter plate voltage is 425 V. but this power can be easily doubled by using 600 volts plate supply. Transmitter or Receiver designed to operate from either 12, 24, 110 V. DC, or 110/220 V. AC power supplies. Power Supply Diagrams furnished. \* Receiver is super-sensitive superhet, with excellent sensitivity & selectivity characteristics, and includes IFO circuit for CW reception. Units priced below are complete with tubes, good clean condition but untested.

**TCS-5 (to 9) TRANSMITTER**, with all tubes, schematic diagram and power supply diagrams, as outlined above. Shpg. wt. 60 lbs. **\$39.95**

**PRICE, EACH**

**TCS-9 (to 14) TRANSMITTER**, same as above but has minor modifications which make these models more desirable. **EACH \$59.95**

**TCS-5 (to 14) RECEIVER**, complete with tubes, schematic diagram and power supply diagrams, as outlined above. Shpg. wt. 50 lbs. **EACH \$69.95**

**WRITE FOR PRICES ON OTHER TCS ACCESSORIES.**

## 600 W. A.F. POWER AMPLIFIER

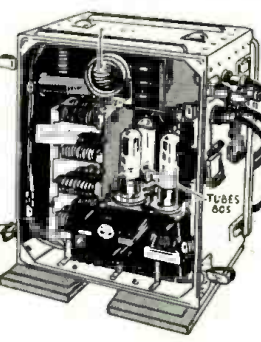

Designed by Bull Telephone Laboratories, Laboratory constructed 600 Watt Audio Power Amplifier (Type 600) for use in airports, shipyards, or wherever high intensity sound may be required. Complete push-pull audio power stage utilizing 4-807 tubes in parallel, with built-in motor blower for cooling. High voltage power supply uses selenium rectifiers, no tubes. Reduces noise and interference. Includes push-pull amplifier to drive to full capacity. Input impedance 250/500 ohms, output impedance 13/6.5 ohms to speaker. Operates from 115 to 230 Volts, 3 phase. Dimensions of wooden chest 24 1/2" x 28 1/2" x 21 1/2". Supplied with tubes, connecting cable, schematic diagram, etc. Shipping weight 200 lbs.

**PRICE EACH, SLASHED TO \$169.50**

## 15-600 KC RECEIVER

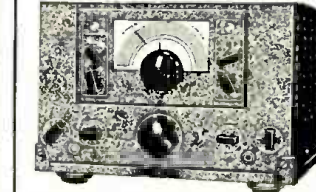

Navy Model RBL, mid. by W. G. and Wells Gardner—(both types) for ship and shore application. Design covers 15 to 600 KC. 110V. AC. 50-60 cycle operation. Throughput CW, ICW and Phone signals. Throughput the entire range of 15 to 600 KC in 15 bands.

Employs 7 modern metal tubes in TRF circuit with regeneration, plus two audio filters to allow choice of two band widths, 600 or 3000 cycles at 20 db down with peak response occurring at 750 and 1000 cps respectively. Also incorporated audio limiter stage which reduces noise and interference. This receiver is of interest to the long and intermediate wave bands, 175 to 17.5 mc.

Supplied complete with tubes, instruction sheets and diagram. Shpg. wt. 135 lbs. **\$79.50**

**PRICE, EACH, EXCELLENT—IN NEW CONDITION \$159.50**

**PRICE, EACH, USED—GOOD CONDITION. \$64.50**

## LIMITED QUANTITY BARGAINS

**GENERAL ELECTRIC 10 KW RF POWER AMPLIFIER**, model RP-3A, designed to increase RF power output of CW transmitters (0.5 to 1.5 mc) to 100 W. or more. Operates on other frequencies. Available NEW, less Rectifier Power Supply and Tubes. **EACH \$795.00**

**COLLINS MODEL MEF TRANSCEIVERS**, covers 60 to 80 mc single channel crystal-controlled Transmitter & Receiver. Full 3 watts RF output. Ideal as 5 meter Walky-Talky. Used—Good Condition. With tubes and cable less other accessories. Operates from 110V. AC-DC. Shpg. wt. 50 lbs. **EACH \$32.50**

**3-RANGE SIGNAL GENERATOR**, well built and highly engineered. This test signal generator is a rare bargain for laboratories, service shops, and for production testing in factories. Known as the OAV-1 Test Generator. It provides any one or all of 3 outputs: (1) a V.H.F. output variable from 150 to 250 mc; (2) a 15 mc. output (which can be changed to another nearby frequency for TV-F alignment); and (3) a 150 kc. output of 1, 1.0, 10.0 and 100 KC by means of a selector switch. Frequency stability is excellent and calibration at least as good as any excellent service signal generator. Includes following tubes 1-5Y3GT, 1-5R7, 1-6AG7, and 2-6002. Operation is from 110 V. DC, 60 cycles, 1-phase. Dimensions are 10 1/2" x 11 1/2" x 11 1/2". Shpg. wt. 85 lbs. NEW units, with operating instructions and Schematic. **\$24.95**

**ONLY**

**DM-37 DYNAMOTORS**, same as DM-35 Dynamotor (625 V. DC at 225 ma) but for 24 V. DC input. Excellent for pleasure boat radio power supply. Used—excellent. **EACH \$7.45**

**PE21B INVERTERS**, 24-27.5 V. DC input, 110 V. 400 cycles/1 phase, 1500 VA. Output, NEW UNTESTED. **EACH \$14.95**

## 600 W. LOUSPEAKER

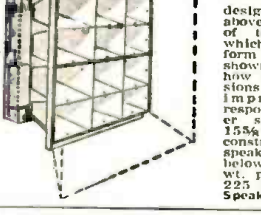

designed for use with above Amplifier, consists of two 6-unit sections which bolt together to form 12-speaker unit shown. Dotted lines show how wooden baffle extensions may be added for improved low-frequency response. Dim. of 6-speaker section 29 1/2" L x 15 1/2" H x 21" D. All steel construction. Includes loud speaker units illustrated below. **UNUSED.** Shpg. wt. per 6-speaker section 225 lbs. **PRICE: PER 6-SPEAKER SECTION, \$75.00**

## 50-60 W. SPEAKER UNIT



Western Electric Speaker units, for horn or baffle-board mtg. NEW units, removed from above speaker. Shock and blast proof diaphragm, will handle up to 60 watts. Response to 7,000 cps, favoring high freq. Impedance 13 ohms. Dim.: 6" x 6" x 4 1/2" deep. Throat opening—1 3/4" dia. Alnico 5 slug wt. 6 lbs. Shpg. wt. 20 lbs. **EACH, SLASHED TO \$11.95**

All Above Material Subject to Prior Sale, 25% Minimum Deposit with All C.O.D.'s, Min. Order \$5.00. All Prices F.O.B. Our Address.

**— TELEMARINE —**  
**COMMUNICATIONS CO.**  
3030 W. 21st Street, Brooklyn 24, N. Y.  
Cable Address: Telemarine N. Y.  
Phone: ES 2-4300



**TCS ANTENNA LOADING COIL**, Used with above equipment to obtain maximum performance with short whip antenna. Has 6-position tapered socket for various lengths of antenna. In metal housing 6" H. x 3 1/2" W. dia. D. Shpg. wt. 6 lbs. **EACH \$7.95**

## V.H.F. TEST EQPT. 150-230 MC.

A Complete Test Instrument covering 150 to 230 mc, operating from 110 V. 50/70 cycles AC. mtfl. for Navy, Model OAV-1. See our ad in May '26 issue of RTN for illustration and full specifications. Permits following functions: (1) Tune a transmitter to given frequency. (2) Tune a receiver to a given frequency. (3) Adjust antenna system, etc. 15 1/2" L x 8 1/2" W x 10 1/2" H. Includes calibration chart, separate receiver, gain control, connector, and line cord. 100% cond. **\$49.50**

## SELECTIVE RINGER for MOBILE or MARINE RADIOTELEPHONES

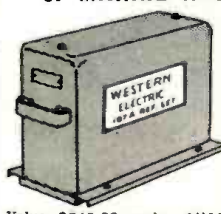

Western Electric Model 107A for use with Bell Telephone System for selective calling of marine or mobile telephones. Alternate 600 and 1500 cycle tones, at a rate of 8 to 11 times per second. Adjust a selector mechanism to close a ringing circuit (not supplied). Dimensions of unit are: 14 1/2" long, 8 1/2" high, 13 1/2" deep. 110 V. AC operating voltage of from 60 to 250 V. is obtaining. Includes instruction book. **NEW-UNUSED units with Instruction Book, Reg. Shpg. wt. 25 lbs. OUR LOW PRICE \$85.00**

Value \$245.00 each. **GUARANTEED SATISFACTORY.** Shpg. wt. 25 lbs. **OUR LOW PRICE \$85.00**

Superior's New Model TC-55



New!



# Streamlined TUBE TESTERS

**FOR**

The Experimenter or Part-time Serviceman, who has delayed purchasing a higher priced Tube Tester. The Professional Serviceman, who needs an extra Tube Tester for outside calls. The busy TV Service Organization, which needs extra Tube Testers for its field men.

Speedy, yet efficient operation is accomplished by: Elimination of old style sockets used for testing obsolete tubes (26, 27, 57, 59, etc.) and providing sockets and circuits for efficiently testing the new Noval and Sub-Minor types.

- You can't insert a tube in wrong socket. Separate sockets are used, one for each type of tube base.
- "Free-point" element switching system Any pin may be used as a filament pin and the voltage applied between that pin and any other pin, or even the "top-cap".
- Checks for shorts and leakages between all elements. Provides a super sensitive method of checking for shorts and leakages up to 5 Megohms between any and all of the terminals. Continuity between various sections is individually indicated.
- Elemental switches are numbered in strict accordance with R.M.A. specification. The 4 position fast-action snap switches are all numbered in exact accordance with the standard R.M.A. numbering system.

Model TC-55 comes complete with operating instructions and charts and streamlined carrying case.

**\$26<sup>95</sup>**  
NET

## PICTURE TUBE TESTER



Superior's New Model TV-40



- Tests all magnetically deflected tubes . . . in the set . . . out of the set . . . in the carton!!
- A complete picture tube tester for little more than the price of a "make-shift" adapter!!

The Model TV-40 is absolutely complete! Self-contained, including built-in power supply, it tests picture tubes in the only practical way to efficiently test such tubes; that is by the use of a separate instrument which is designed exclusively to test the ever increasing number of picture tubes!

### SPECIFICATIONS

Tests all magnetically deflected picture tubes from 7 inch to 30 inch types. • Tests for quality by the well established emission method. All readings on "Good-Bad" scale. • Tests for inter-element shorts and leakages up to 5 megohms. • Test for open elements.

Model TV-40 comes absolutely complete — nothing else to buy. Housed in round cornered, molded bakelite case. Only . . .

**\$15<sup>85</sup>**  
NET



Superior's New Model TV-11 Standard Professional

## TUBE TESTER

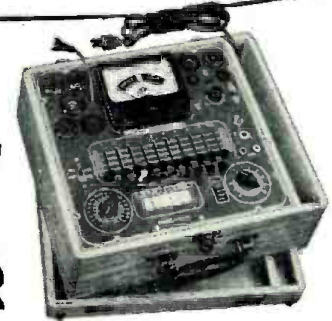

- ★ Uses the new self-cleaning Lever Action Switches for individual element testing. Because all elements are numbered according to pin-number in the RMA base numbering system, the user can instantly identify which element is under test. Tubes having tapped filaments and tubes with filaments terminating in more than one pin are truly tested with the Model TV-11 as any of the pins may be placed in the neutral position when necessary.

- ★ The Model TV-11 does not use any combination type sockets. Instead individual sockets are used for each type of tube. Thus it is impossible to damage a tube by inserting it in the wrong socket.

- ★ Free-moving built-in roll chart provides complete data for all tubes.

- ★ NOISE TEST: Phono-jack on front panel for plugging in either phones or external amplifier will detect microphonic tubes or noise due to faulty elements and loose internal connections.

EXTRA SERVICE — The Model TV-11 may be used as an extremely sensitive Condenser Leakage Checker. A relaxation type oscillator incorporated in this model will detect leakages even when the frequency is one per minute.

The model TV-11 operates on 105-130 Volt 60 Cycles A.C. Comes housed in a beautiful hand-rubbed oak cabinet complete with portable cover.

**\$47<sup>50</sup>**  
NET



## TRANS-CONDUCTANCE TUBE TESTER

Superior's New Model TV-12



### TESTING TUBES

- ★ Employs improved TRANS-CONDUCTANCE circuit. An in-phase signal is impressed on the input section of a tube and the resultant plate current change is measured. This provides the most suitable method of simulating the manner in which tubes actually operate in Radio & TV receivers, amplifiers and other circuits. Amplification factor, plate resistance and cathode emission are all correlated in one meter reading.

- ★ NEW LINE VOLTAGE ADJUSTING SYSTEM. A tapped transformer makes it possible to compensate for line voltage variations to a tolerance of better than 2%.

- ★ SAFETY BUTTON—protects both the tube under test and the instrument meter against damage due to overload or other form of improper switching.

- ★ NEWLY DESIGNED FIVE POSITION LEVER SWITCH ASSEMBLY. Permits application of separate voltages as required for both plate and grid of tube under test, resulting in improved Trans-Conductance circuit.

### TESTING TRANSISTORS

A transistor can be safely and adequately tested only under dynamic conditions. The Model TV-12 will test all transistors in that approved manner, and quality is read directly on a special "transistor only" meter scale.

Model TV-12 housed in handsome rugged portable cabinet sells for only

**\$72<sup>50</sup>**  
NET

ALSO TESTS TRANSISTORS!

**EXAMINE BEFORE YOU BUY!  
USE APPROVAL FORM ON NEXT PAGE**

New!



# Superior's New Model 670-A SUPER-METER



### SPECIFICATIONS

D.C. VOLTS: 0 to 7.5/15/75/150/750/1,500/7,500 Volts  
 A.C. VOLTS: 0 to 15/30/150/300/1,500/3,000 Volts  
 OUTPUT VOLTS: 0 to 15/30/150/300/1,500/3,000 Volts  
 O.C. CURRENT: 0 to 1.5/15/150 Ma. 0 to 1.5/15 Amperes  
 RESISTANCE: 0 to 1,000/100,000 Ohms 0 to 10 Megohms  
 CAPACITY: .001 to 1 Mfd. 1 to 50 Mfd. (Good-Bad scale for checking quality of electrolytic condensers.)  
 REACTANCE: 50 to 2,500 Ohms 2,500 Ohms to 2.5 Megohms  
 INDUCTANCE: .15 to 7 Henries 7 to 7,000 Henries  
 DECIBELS: -6 to +18 +14 to +38 +34 to +58

### ADDED FEATURE:

Built-in ISOLATION TRANSFORMER reduces possibility of burning out meter through misuse.

The Model 670-A comes housed in a rugged crackle-finished steel cabinet complete with test leads and operating instructions.

**\$28<sup>40</sup>**  
NET



## Superior's New Model 20,000 OHMS PER VOLT TV-60 ALLMETER



Includes services never before provided by an instrument of this type. Read and compare features and specifications below!

### FEATURES

- Giant recessed 6 1/2 inch 40 Microampere meter with mirrored scale.
- Built-in Isolation Transformer.
- Use of the latest type printed circuit and 1% multipliers assure unchanging accurate readings.

### SPECIFICATIONS

8 O.C. VOLTAGE RANGES: (At a sensitivity of 20,000 Ohms per Volt) 0 to 15/75/150/300/750/1500/7500/30,000 Volts.  
 7 A.C. VOLTAGE RANGES: (At a sensitivity of 5,000 Ohms per Volt) 0 to 15/75/150/300/750/1500/7500 Volts.  
 3 RESISTANCE RANGES: 0 to 2,000/200,000 Ohms, 0-20 Megohms  
 2 CAPACITY RANGES: .00025 Mfd. to 30 Mfd.  
 5 O.C. CURRENT RANGES: 0-75 Microamperes, 0 to 7.5/75/750 Milliampers, 0 to 15 Amperes.  
 3 DECIBEL RANGES: -6 db to +58 db  
 RF SIGNAL TRACER SERVICE: Enables following the R.F. signal from the antenna to speaker of any radio or TV receiver and using that signal as a basis of measurement to first isolate the faulty stage and finally the component or circuit condition causing the trouble.  
 AUDIO SIGNAL TRACER SERVICE: Functions in the same manner as the R.F. Signal Tracing service specified above except that it is used for the location of cause of trouble in all audio and amplifier systems.

Model TV-60 comes complete with book of instructions; pair of standard test leads; high-voltage probe; detachable line cord; R.F. Signal Tracer Probe and Audio Signal Tracer Probe. Pliofilm bag for all above accessories is also included. Price complete. Nothing else to buy. ONLY

**\$52<sup>50</sup>**



## Superior's New Model TV-50 GENOMETER



A versatile all-inclusive GENERATOR which provides ALL the outputs for servicing:

A.M. Radio • F.M. Radio • Amplifiers • Black and White TV • Color TV

R. F. SIGNAL GENERATOR: Provides complete coverage for A.M. and F.M. alignment. Generates Radio Frequencies from 100 Kilocycles to 60 Megacycles on fundamentals and from 60 Megacycles to 180 Megacycles on powerful harmonics. • VARIABLE AUDIO FREQUENCY GENERATOR: In addition to a fixed 400 cycle sine-wave audio, the Genometer provides a variable 300 cycle to 20,000 cycle peaked wave audio signal. • BAR GENERATOR: Projects an actual Bar Pattern on any TV Receiver Screen. Pattern will consist of 4 to 16 horizontal bars or 7 to 20 vertical bars. • CROSS HATCH GENERATOR: Genometer will project a cross-hatch pattern on any TV picture tube. The pattern will consist of non-shifting horizontal and vertical lines interlaced to provide a stable cross-hatch effect. • DOT PATTERN GENERATOR (FOR COLOR TV): The Dot Pattern projected on any color TV Receiver tube by the Model TV-50 will enable you to adjust for proper color convergence. • MARKER GENERATOR: The following markers are provided: 189 Kc., 262.5 Kc., 456 Kc., 600 Kc., 1000 Kc., 1400 Kc., 1600 Kc., 2000 Kc., 2500 Kc., 3579 Kc., 4.5 Mc., 5 Mc., 10.7 Mc., (3579 Kc. is the color burst frequency.)

MODEL TV-50 comes absolutely complete with shielded leads and operating instructions.

Only

**\$47<sup>50</sup>**  
NET

# SHIPPED ON APPROVAL NO MONEY WITH ORDER - NO C.O.D.

TRY ANY of the instruments on this page, for 10 days before you buy. If completely satisfied then send down payment and pay balance as indicated on coupon. No Interest or Finance Charges added! If not completely satisfied return unit to us, no explanation necessary.

MOSS ELECTRONIC DISTRIBUTING CO., INC.  
Dept. D-248, 3849 Tenth Ave. New York 34, N. Y.

Please send me the units checked. I agree to pay down payment within 10 days and to pay the monthly balance as shown. It is understood there will be no finance or interest charges added. It is further understood that should I fail to make payment when due, the full unpaid balance shall become immediately due and payable.

Name \_\_\_\_\_  
 Address \_\_\_\_\_  
 City \_\_\_\_\_ Zone \_\_\_\_\_ State \_\_\_\_\_

All prices net, F.O.B., N.Y.C.

- Model TC-55 ..... Total Price \$26.95  
\$6.95 within 10 days. Balance \$5.00  
monthly for 4 months.
- Model TV-12 ..... Total Price \$72.50  
\$22.50 within 10 days. Balance \$10.00  
monthly for 5 months.
- Model 670-A ..... Total Price \$28.40  
\$7.40 within 10 days. Balance \$3.50  
monthly for 6 months.
- Model TV-11 ..... Total Price \$47.50  
\$11.50 within 10 days. Balance \$6.00  
monthly for 6 months.
- Model TV-40 ..... Total Price \$15.85  
\$3.85 within 10 days. Balance \$4.00  
monthly for 3 months.
- Model TV-50 ..... Total Price \$47.50  
\$11.50 within 10 days. Balance \$6.00  
monthly for 6 months.
- Model TV-60 ..... Total Price \$52.50  
\$12.50 within 10 days. Balance \$8.00  
monthly for 6 months.

# ATR SHAV-PAK NEW, LOW PRICE!



**SHAVE IN THE COMFORT  
OF YOUR CAR,  
Boat or Plane!**



Plugs into  
Cigarette Lighter  
Receptacle on Dash  
**\$11.95**  
LIST PRICE

Specially Designed for  
Operating Standard A.C.  
Electric Shavers in  
Automobiles, Buses,  
Trucks, Boats, and  
Planes.

TYPE	INPUT D.C. VOLTS	A.C. OUTPUT 60 CYCLES	OUTPUT WATTAGE	LIST PRICE
6-SPB	6	115 volts	15	11.95
12-SPB	12	115	15	11.95

## Introducing ATR MIGHTY MIDGET portable INVERTER WITH GREATER OUTPUT

DICTATE REPORTS ACCURATELY-PROMPTLY!

**make your car, boat or plane  
a "rolling office"**

with ATR INVERTERS



Plugs into  
Cigarette Lighter  
Receptacle on Dash

for changing your  
storage battery  
current to A.C.  
*Household  
ELECTRICITY  
Anywhere  
in your own car!*

**\$19.95**  
AND UP  
LIST PRICE

ATR INVERTERS . . .  
especially designed for operating  
standard 110 volt A. C. . . .

- DICTATING MACHINES • TAPE RECORDER
- ELECTRIC RAZORS • WIRE RECORDERS

TYPE	INPUT D.C. VOLTS	A.C. OUTPUT 60 CYCLES	OUTPUT WATTAGE	LIST PRICE
6-DME	6	115 volts	30-40	19.95
6H-DME	6	115 volts	60-75	29.95

Above Inverters also available for 12-volt operation.

See your jobber or write factory today  
for complete information

**ATR** AMERICAN TELEVISION & RADIO CO.  
Quality Products Since 1931  
SAINT PAUL 1, MINNESOTA - U. S. A.

# TV Programs on Magnetic Tape

Newly developed system permits up to one hour of program material to be recorded on a single 14-inch reel of tape.

A NEW process for recording and reproducing TV programs on magnetic tape has been publicly demonstrated by Amper Corporation of Redwood City, Cal.

The new video recorders, several of which have been ordered by the major television networks, operate at 15 ips and provide a full hour of television program on 14" reels of 2" magnetic tape.

The system records both picture and sound on a single magnetic tape 2 inches wide. The picture quality is said to be considerably better than that obtained with current kinescope techniques using photographic film. The "gray scale" (the ability to reproduce accurately all shades from black to white) is uniform in this new system. On the other hand, the gradient from black to white is not uniform in photographic film, the company noted.

The resolution of the new system is said to be beyond the capability of the average television receiver. Thus, when a tape recorded program is telecast, the limitation of picture quality will be in the home receiver rather than in the quality of transmission. The maximum number of lines a TV station can transmit is 340. The new tape recorder will record and reproduce more than 320 lines.

With the new system, programs can be recorded directly from the TV camera, from a TV receiver, from TV transmission lines, or from microwave relay systems. The program can then be immediately replayed without processing of any kind. The tape can be erased and re-used, if desired.

One of the most interesting features of this new equipment is the type and operation of the heads. Electrical signals are passed through a coil around an electromagnet (the recording head) with the strength of the magnetic field in the recording head dependent on the electrical current in the coil at a given instant. In turn, the magnetic

field impresses a pattern on the magnetic surface of the tape as it passes the recording head. The pattern on the tape thus corresponds to the electrical signals in the coil on the recording head. Since these signals are generated by the TV camera, the pattern on the tape corresponds to what the camera "sees."

To reproduce the picture, the tape is passed across the same magnetic head. The magnetic pattern on the tape induces a current in the coil around the head. Since the pattern corresponds to the original picture, the induced current can be fed to a TV transmitter just as though it were coming directly from the TV camera.

To obtain the 4 mc. response needed for video recording, theoretically the tape speed would have to be 2000 ips. At that rate, a reel of magnetic tape 14" in diameter would record only 29 seconds of program material.

In order to cope with this problem Ampex engineers have developed a system which permits a tape speed of only 15 ips, yet allows a full hour's program to be recording on a single 14" reel. To achieve this relatively slow tape speed, a magnetic head assembly which rotates at a high speed is used, giving an effective tape speed sufficient to record and reproduced the full 4-mc. bandwidth. Thus, while the tape moves slowly, the heads move across the surface of the tape at a very high speed. The head assembly actually consists of four heads placed on a rotating drum. One head is always in contact with the surface of the tape. As one head leaves the tape, the next head makes contact. The magnetic pattern is recorded transversely across the tape instead of longitudinally as in conventional audio recorders. The sound that accompanies the picture is recorded in the ordinary manner along one edge of the magnetic tape.

-30-

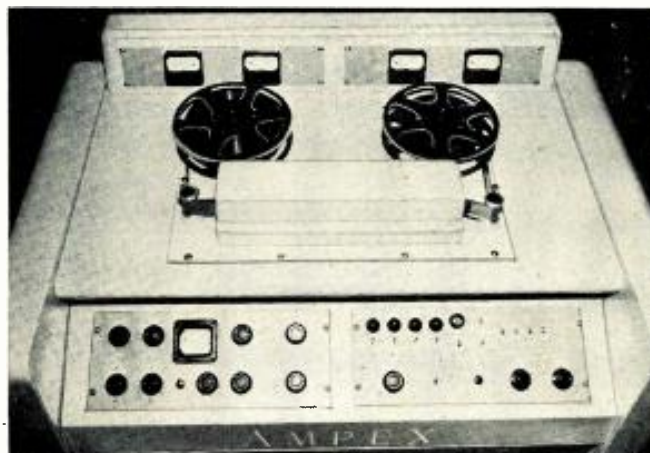

Top view of the Amper tape recorder for TV. The special tape for this unit is 2 inches wide and both video and audio portions of the program are recorded on the one tape. Despite the number of controls, recording and playback involve the pushing of only one button for each operation.

# LIFETIME GUARANTEED TUBES

## BRAND NEW PICTURE TUBES

- RCA Licensed
- One Year Unconditional Guarantee

Type	Price	Type	Price
10BP4	\$11.90	17BP4	\$20.63
12LP4	\$14.38	19AP4	\$24.81
14BP4	\$16.86	21AP4	\$28.79
16RP4	\$19.38	21EP4	\$28.79
16LP4	\$19.38	24AP4	\$42.50

Picture Tubes shipped F.O.B. Harrison, N. J. Above types are most popular. However, you may order any equivalent size at the same price.

## NEW INDOOR ANTENNA



Both UHF and VHF. Brings better reception than most outdoor antennas. Use on top of TV.

List Price \$9.95

Your Price  
Lots of 3  
**\$3.29**  
\$3.99 each



## USED TV SETS

Picture Tube Guaranteed To Work!

- Emerson
- RCA
- Philco
- GE
- Motorola
- Zenith
- Capehart
- Others

10" SET Table Model... \$16.95 Console... \$19.95	14" SET Table Model... \$27.95 Console... \$31.00
12" SET Table Model... \$22.95 Console... \$24.95	16" SET Table Model... \$32.00 Console... \$34.95
17" SET Table Model... \$37.00 Console... \$39.00	

All prices F.O.B. Harrison, N. J. Prices on request for 19", 20", 21" and 24" sets.

## LOOK WHAT YOU GET FREE!

**FREE BONUS BOX** With Every \$25 Order

- 1 RCA Cheater Cord
- 10 Assorted resistors
- 10 Assorted 2 color "blank" tube cartons
- 1 6BQ6GT tube
- 1 6AU6 tube
- 1 6CB6 tube

## FREE CLOCK RADIO

With Every \$125 Purchase Within 30 Days

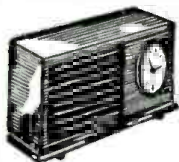

Wakemaster clock radio with famous Sessions clock movement wakes you to music or alarm. May be purchased outright from MAJOR BRAND for \$17.95. In ivory or rust.

**FREE GIFT CERTIFICATE\*** worth \$5 toward the purchase of any of our merchandise on future orders will be sent with any order of \$50 or more.

\*Free Gift Certificate cannot be used to obtain another certificate unless order is \$55 or more.

## HERE'S HOW LIFETIME GUARANTEED TUBES SAVE YOU MONEY!

- We Guarantee to Replace Tubes Labeled MAJOR BRAND Forever
- Each Tube Individually Boxed and Guaranteed
- Over A Half Million Tubes Always In Stock
- Immediate Shipment
- Free Postage On All Orders With Full Remittance
- There are fewer "call backs"
- There are no "out of date" tubes
- "Peak Performance" testing in our fully equipped Testing Department before shipment guarantees quality

OZ4	.43	6A7	.57	6K6GT	.37	12AV6	.35
1B7GT	.43	6A8	.45	6K7	.39	12AV7	.67
1A7G7	.43	6AB4	.43	6K8	.65	12AX4GT	.65
1B3GT	.65	6AC7	.67	6L6	.68	12AX7	.58
1C5GT	.41	6AF4	.79	6L7	.42	12AZ7	.63
1D5GP	.43	6AG5	.50	6N7	.60	12B4	.68
1E7GT	.41	6AG7	.69	6Q7	.40	12BA6	.46
1G6GT	.41	6AH5	.69	6S4	.40	12BD6	.48
1H4C	.43	6AJ5	.70	6SA7	.45	12BE6	.46
1H5GT	.47	6AK5	.54	6SC7	.48	12BH7	.60
1J6GT	.47	6AL5	.39	6SG7	.41	12BY7	.65
1L4	.45	6AQ5	.46	6SH7	.43	12BZ7	.61
1L6	.55	6AR5	.46	6S17	.43	12CUG	.95
1LA4	.57	6AS5	.48	6SK7	.45	12SA7	.45
1LA6	.57	6AS6	1.70	6SL7GT	.55	12S17	.45
1LB4	.57	6AS7G	2.19	6SN7GT	.55	12SK7	.45
1LC5	.49	6AT6	.39	6SQ7	.39	12SN7GT	.56
1LC6	.47	6AU4GT	.65	6SR7	.42	12SQ7	.37
1LD5	.57	6AU5GT	.59	6S57	.41	12SR7	.45
1LE3	.57	6AU6	.42	6T1	.95	12V6GT	.45
1LG5	.57	6AV5GT	.65	6T8	.68	12X4	.37
1LM4	.64	6AV6	.39	6U8	.75	14A7	.42
1LN5	.47	6AX4GT	.60	6V3	.80	14B6	.38
1NSGT	.50	6AX5GT	.57	6V6GT	.46	14Q7	.50
1R5	.50	6B4C	.52	6W4GT	.39	19B6G6	1.15
1S5	.42	6B8	.69	6W6GT	.53	19T8	.65
1T4	.50	6BA6	.47	6X4	.34	24A	.39
1U4	.47	6BA7	.58	6X5	.34	25AV5GT	.78
1U5	.42	6BC5	.47	6X8	.73	25BQ6GT	.78
1V2	.65	6BC7	.80	6Y6G	.55	25L6GT	.47
1X2	.61	6BE6	.45	7A4	.45	25W4GT	.43
2A3	.55	6AU6	.42	7C1	.95	25Z5	.37
2A5	.57	6BF6	.50	7A6	.45	25Z6	.37
2A7	.55	6BH6	.50	7A7	.43	27	.25
3A4	.51	6B16	.47	7A8	.45	35A5	.46
3A5	.50	6BK5	.68	7B5	.39	35B5	.50
3AL5	.45	6BN7	.76	7B6	.42	35C5	.50
3AU6	.56	6BL7GT	.75	7B7	.41	35L6GT	.47
3BC5	.54	6BN6	.58	7B8	.45	35W4	.34
3BN6	.70	6BQ6GT	.78	7C4	.39	35Y4	.34
3CB6	.52	6BQ7	.78	7C5	.42	35Z3	.39
3Q4	.46	6BY5C	.58	7C6	.43	35Z5GT	.34
3Q5GT	.57	6BZ7	.88	7C7	.45	37	.29
3S4	.47	6C4	.37	7E5	.45	50A5	.46
3V4	.47	6C5	.35	7E6	.55	50B5	.50
4B07	.89	6C6	.49	7E7	.70	50C5	.50
4BZ7	.95	6CD6G	1.15	7F7	.59	50L6GT	.43
5AW4	.75	6D6	.48	7F8	.70	75	.42
5BG6G	1.15	6E5	.44	7G7	.75	76	.42
5J6	.63	6F5	.37	7H7	.50	77	.38
5T4	.69	6F6	.38	7J7	.75	78	.38
5U4G	.43	6G6	.40	7K7	.75	80	.34
5UR	.74	6H6	.38	7L7	.75	84/624	.44
5V4G	.59	6J4	1.79	7N7	.50	117L7GT	1.09
5Y3	.31	6J5	.39	12AT6	.37	117N7GT	1.09
5Y4C	.36	6J6	.47	12AT7	.66	117P7GT	1.09
5Z3	.41	6J7	.43	12AU6	.37	117Z3	.35
		6J8C	.85	12AU7	.53	117Z6GT	.63

ALL PARTS SHIPPED F. O. B. FROM HARRISON, N. J.

WE PAY ALL POSTAGE on orders shipped in USA. Territories and APO's. Send only purchase price of merchandise. Please include approximate postage on foreign shipments. All orders subject to prior sale. Add 25c handling on orders under \$5.00. Quantity users write for special discount.

Write for FREE Tube List—Order Blank—and FREE Sample Tube Carton. We want Y-O-U on Our Mailing List!

## SPECIAL SURPRISE

Mention where you saw our ad and we will send you FREE three 6SNGT's with any order of \$10 or more.

## MAJOR BRAND TUBE CO.

Romano Bldg. ESsex 4-1106 Harrison, N. J.

don't do it  
the hard way!

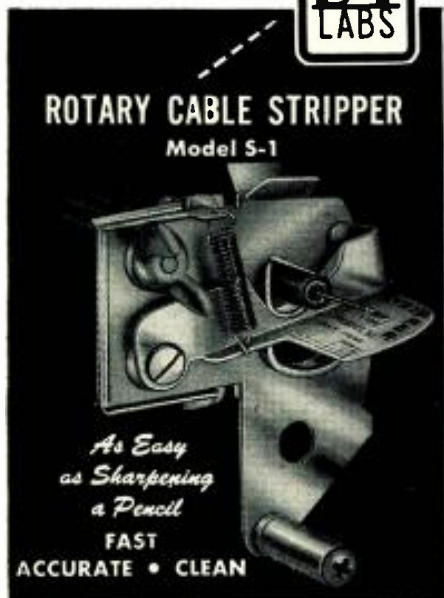
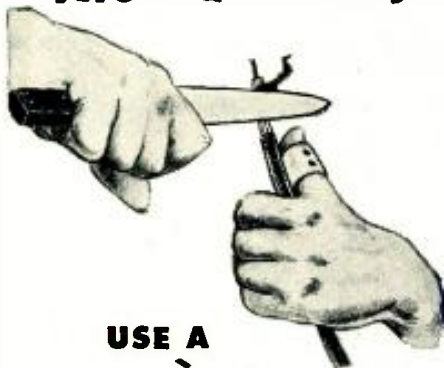

ROTARY CABLE STRIPPER  
Model S-1

As Easy  
as Sharpening  
a Pencil

FAST  
ACCURATE • CLEAN

and Practically AUTOMATIC

- Cuts and strips the outer covering of coax cable without injuring the shielding.
- Cuts the shielding without pulling, fraying or unbraiding.
- Cuts and strips the inner insulation and . . .
- Measures just the right length of lead desired.
- Ideal for stripping all insulated wire and cable — as well as non-metallic tubing.

— and its **ONLY \$375**  
LIST

A Must For Your Kit —  
Get One Today  
at your Parts Distributor.

**BLONDER-TONGUE LABORATORIES, INC.**  
Dept. JG-4, Westfield, New Jersey



Manufacturers of TV Cameras,  
TV Amplifiers, Boosters,  
UHF Converters, TV Accessories  
and Originators of the Masterline  
and 'Add-A-Unit'  
Master TV Systems.

## Single-Sideband

(Continued from page 57)

distort the quality of the audio intelligence. The total input power required from the prime source of power, whether batteries, motor-generator, etc., is considerably less for the SSB system than for a comparable AM system. For transmitters in the region of 100 to 1000 watts in peak envelope output power, the input a.c. power of the SSB system will, in general, be 25% to 50% that of the AM system. The advantage to a mobile station (airborne or mobile-marine) is rather obvious.

The physical size and weight will be considerably less in the SSB case. This, in many instances, will be a factor of from two to four times between the two systems. This matter of power consumption and weight is of particular importance in airborne communication equipment applications.

It is believed that conversion of an AM radio telephone system to SSB can only be appreciated by the user when operation of such a system involves signals which are weak and near the ambient noise level. It will then be apparent that signals that are only slightly above the receiver noise level will be completely intelligible

whereas with the conventional AM-type of transmission it might only be possible to detect the carrier signal with a beat frequency oscillator.

### Conclusions

Just as surely as night follows day single-sideband will supplant practically all of the AM radiotelephone systems now in use. There will undoubtedly be reaction in some circles against this new mode of transmission. This is to be expected—it is human nature. Progress will be made in spite of ourselves. History has proven this many hundreds of times. Despite the added complexity and considerably different techniques of single-sideband the average technician and user can become accustomed to them and will learn in a very short time to appreciate the several advantages. There will shortly be many reputable manufacturers offering single-sideband gear to the commercial users. Look over the market and make your choice carefully. See you on single sideband!

### REFERENCES

1. *The Product Detector: "Single Sideband for the Radio Amateur,"* published by the ARRL, West Hartford, Conn.
2. *Panoramic Radio Products, Inc.,* 10 S. Second Ave., Mt. Vernon, N. Y.
3. *Berkeley Division, Beckman Instruments, Inc.,* 2200 Wright Ave., Richmond, California.
4. *Hewlett-Packard Co.,* 3636A Page Mill Road, Palo Alto, California.

## A TWO-TRANSISTOR BROADCAST RECEIVER

**M**ANY readers have expressed an interest in a pocket broadcast receiver using transistors. One recently released circuit, which calls for two readily available transistors, may meet these readers' requirements and is, therefore, reproduced here.

By using subminiature parts and assembling the unit with great care, the entire receiver can be built into a plastic box measuring a mere 2½" wide, 2½" long, and 1¼" deep. The box should be of the type that opens at the top to facilitate mounting of the components. The tuning capacitor, "Loopstick," pin jacks, and transistors are all installed in the bottom of the case as are the batteries and their holder.

The circuit is a regenerative type. Feedback is from the collector to the emitter. Since the emitter circuit impedance is very low, the fixed capacitor and "Loopstick" are placed in the col-

lector circuit. Here the impedance is moderately high. The tickler winding feeds the emitter. In order to permit the transistor to oscillate and still detect the signal, a separate 1N34A diode rectifier is used.

The circuit can be used with either crystal or dynamic earphones. If a crystal earpiece is used, a 4700-ohm resistor should be connected across the output lugs to which the earphone is connected. If the dynamic earphone is used the resistor must be omitted.

The transformer used in this circuit is a special miniature transistor unit made by Argonne Electronics Mfg. Corp., available at jobbers as the AR-104.

Those who prefer to buy all of the parts from a single source can obtain a kit from Lafayette Radio, 100 Sixth Ave., New York 13, New York for \$11.80 (less earphone). It is catalogued as the KT-68.

Schematic of a two-transistor broadcast-band miniature receiver. The "secondary" of the antenna coil is a separate winding on the "Loopstick." Regeneration will occur with from 5 to 15 turns. Correct number should be determined experimentally.

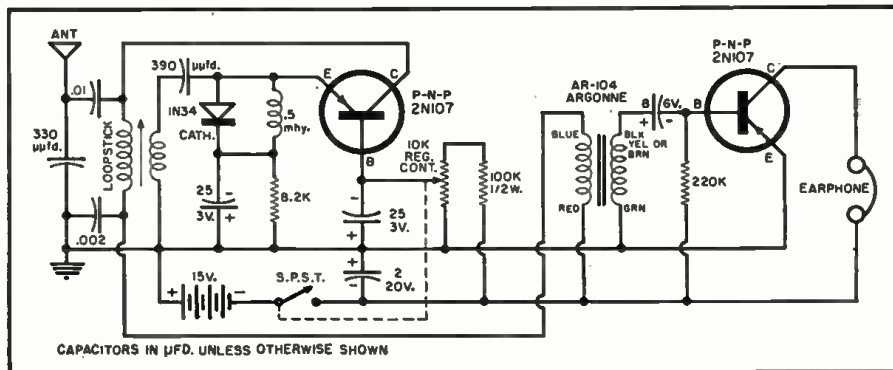

# 4 WAYS TO BETTER PICTURES THIS SUMMER!

PHOTOGRAPHY IS FUN . . . WHEN THE PICTURES YOU TAKE TURN OUT THE WAY YOU WANT THEM. THESE OUTSTANDING ZIFF-DAVIS PHOTO PUBLICATIONS WILL SHOW YOU HOW TO GET THE BEST PICTURES YOU'VE EVER TAKEN!



**the world's leading photographic magazine**

If you own a 35mm camera . . . or plan to buy one soon . . . don't miss this big Special 35mm Issue of POPULAR PHOTOGRAPHY. It's filled with tips, suggestions, "how-to" features and great pictures you're sure to profit from and enjoy!

**AUGUST ISSUE ON SALE JULY 5**



**lists virtually every piece of photo equipment available!**

Contains over 1,000 illustrations of the latest cameras, filters, films and papers, processing materials, movie, lighting; stereo, projection and other accessories. If you want to buy, sell, or trade equipment, here's your guide!

**NOW ON SALE**

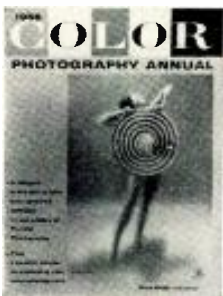

**"must" reading for color fans**

Everybody's shooting color! And here's the world's first Annual devoted exclusively to color photography—including the largest collection of color photos ever published in a single issue! A nationwide newsstand bestseller!

**NOW ON SALE**



**a selection of the world's greatest photographs**

Coming soon, the 1957 PHOTOGRAPHY ANNUAL will be a brilliant showcase for the world's finest photos—both black-and-white and color. A handy reference section tells you how all of the pictures were taken—will help you improve the quality of your own work!

**ON SALE SOON**

**LOOK FOR THESE ZIFF-DAVIS MAGAZINES AT YOUR FAVORITE NEWSSTAND!**



ZIFF-DAVIS PUBLISHING COMPANY, 366 Madison Avenue, New York 17, New York

# AMERICA'S FINEST VALUES IN "LOW COST" HIGH FIDELITY

## ECONOMY 20 WATT AMPLIFIER \$22.95

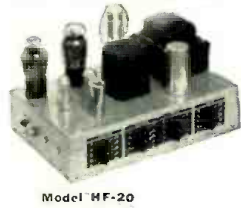

### NEW 1957 MODEL

Push-Pull 6L6 Output Tubes  
Response 30-15,000 CPS  
Bass and Treble Tone Controls  
Input for Xtal or Dynamic Mike  
Input for Xtal or V.R. Phono

With CU-14Y, 12" Coax Speaker...\$32.95  
With P15-CR, 15" Coax Speaker...\$42.95  
With Imperial IV System...\$39.95  
With SP-12125CR...\$44.95 With HF-33GE...\$69.95

A tremendous High Fidelity amplifier value. Response 30 to 15,000 cps. Electronic bass and treble boost by separate tone controls. Use this amplifier with any record changer having crystal or variable reluctance cartridge, radio tuner or high impedance crystal or dynamic microphone. 20 watt power output. Use with any 4 or 8 ohm speaker or 25 ohm line. Chassis size 7 3/4" x 10 1/2" x 7 3/4" high. Complete with tubes: 2-6L6, 2-6CA, 12AX7 and 5U4G. This is a terrific value. A ready to use high fidelity amplifier at less than the cost of a kit. Ship. wt. 17 lbs. Model HF-20, 20 watt Hi-Fi amplifier. McGee's sale price, \$22.95.

## CONSOLE HI-FI SPEAKER SYSTEM \$49.95

12" G.E. PM WOOFER—10" PM MID-RANGE—  
8" G.E. MODEL 850 MID-HIGH RANGE SPEAKER  
AND 600 CYCLE L-C CROSSOVER NETWORK.

Have Juke Box tone quality in your own home. Strictly High Fidelity. Three speakers all connected to 600 cycle frequency dividing network, so that only 2 wires feed the system from any 4 or 8 ohm radio or amplifier. A variable tone compensating control incorporated in the circuit provides brilliant high or low tone to your own taste. Any amplifier that you now have will give you a much wider selection of acoustical arrangements with this speaker system. The 3-way system is shipped ready to connect to your amplifier or hi-fi radio. Equipped with General Electric 12" woofer, an 8" famous G.E. 850 plus a 10" middle range speaker. Frequency response 30 to 15,000 cps. Take your choice of cabinets: blonde oak, walnut or mahogany. (Specify finish desired when ordering) 37" high, 24" wide and 20" deep. Ship. wt. 75 lbs. Stock No. HF-33GE, Sale price, \$49.95. Model HF-33GE, console speaker system same as above, except 12" G.E. PM Model 1201 plus 8" G.E. PM Model 850, 10" mid-range speaker and 5" hard cone tweeter. Sale price, \$54.95. (Specify cabinet finish.) Model HF-55GE, super deluxe quality console speaker system, same as HF-33GE described above, except has 15" 21 oz. Alnico V magnet woofer, 10" mid-range PM speaker and Model 4401 University horn type tweeter. All 3 systems incorporate 600 cycle L-C type crossover network with variable tone compensating control. Model HF-55GE. Sale price \$69.95 (specify cabinet finish).

## DELUXE CONSOLE SPEAKER SYSTEM \$89.50

15" UTAH WOOFER—8" GE—2-5" TWEETERS—CROSSOVER  
New, deluxe quality High-Fidelity console speaker system. Has 15" Utah woofer with 21 oz. Alnico V magnet, 8" model 850 G.E. mid-range speaker and two 5" tweeters. This is the finest console speaker system that we offer. Available in blonde oak or natural mahogany finish. Cabinet size, 49" high, 31" wide and 23" deep. Has 3/4" length doors with attractive hardware and ornament on grill below doors. All 4 speakers are connected to a 600 cycle frequency dividing network, so that there is only one wire to connect to any 4 or 8 ohm output of your radio or amplifier. Has variable tone compensating control built-in. Model HF-55GR, deluxe quality Hi-Fi console speaker system. Ship. wt. 150 lbs. (Specify cabinet finish desired.) Sale price, \$89.50.

## NEW 15" COAXIAL IMPERIAL SPEAKER SYSTEM

20 to 17,500 CPS  
BUILT-IN CROSSOVER  
CHOICE OF BLOND, MAHOGANY OR MAPLE

SALE PRICE  
**\$34.95**

Imperial Model 15-BF speaker system. Choice of blond, mahogany or maple cabinet. Baffle is equipped with a 15 watt, 15" coaxial, high fidelity PM speaker with coaxially suspended 5" tweeter. Built-in crossover connects the tweeter electrically to the woofer. Only 2 wires to connect to any 8 ohm output from your high fidelity amplifier. Ideal for use with our Imperial 30 or HF-20 amplifiers described above. Frequency response down to 20 cps and 17,500 cps. Baffle is 40" high, 26" wide and 21" deep. Overall height is 40". Baffle has acoustical lining for fine musical reproduction. This speaker system compares with units selling for \$100.00. Stock No. IMP-15BF, 15" coaxial speaker and baffle. Ship. wt. 53 lbs. Sale price, \$34.95. Specify cabinet finish; blond, mahogany or maple when ordering. Stock No. IMP-XPR, speaker system same as above, except equipped with our P15-CR, 15" coaxial PM speaker described on opposite page. Sale price, \$39.95.

## THEATER QUALITY HIGH FIDELITY SPEAKER SYSTEM \$39.95

15" WOOFER PLUS—ELECTROVOICE MODEL 847  
MID-HIGH RANGE SPEAKER—600 CYCLE LC  
CROSSOVER.

A theatre quality, powerful speaker system for homes and sound demonstration rooms. This speaker arrangement will connect to any high fidelity audio amplifier (8 ohms impedance) Features a 15" electrodynamic heavy duty woofer which is equal to a PM speaker with up to 10 lbs. of Alnico V magnet. This woofer reproduces the low audio register from 600 cycles down to 20 cps. An Electro-Voice Model 847 horn type speaker is used for the middle range and high range of audio. These two speakers are connected to a 600 cycle inductive-capacity crossover network. Built in the network is the field exciter for the 15" woofer. You could spend over \$100 for a speaker system and not beat this one. Stock No. EV1587X, McGee's sale price, \$39.95.

## NEW IMPERIAL SPEAKER SYSTEMS

Imperial IV  
with 8" G.E.  
High Fidelity  
Speaker  
**\$19.95**

3-Way  
Imperial VI  
with 12" G.E.  
Speaker  
**\$29.95**

New 1957 Model IMPERIAL IV, High Fidelity speaker system with General Electric 8" speaker. Housed in a high quality leatherette covered plywood cabinet 10" x 10" x 24" long. Fully enclosed; covered on all sides except back. Use as an auxiliary speaker or with any high fidelity radio, amplifier or home music system. The IMPERIAL IV contains a General Electric Model 850 extended range high fidelity 8" PM speaker with 6.8 oz. Alnico V magnet and curvilinear cone with 8 ohm voice coil and a 5" tweeter. Response 50 to 15,000 cps. Model IV Imperial \$19.95.

1957 Model Imperial VI, 3-way speaker system. Baffle is of heavy wood, leatherette covered. Similar in appearance to the Imperial IV pictured above, except 4" taller and 2" deeper. Equipped with 3 m.t. speakers. A 2" G.E. Model 1203 with 9 oz. Alnico V magnet, plus 5 1/2" PM for middle range and 3" tweeter. Simple to connect to any high fidelity amplifier. (8 ohm impedance). Stock No. IMP-VI, Sale price, \$29.95. Ideal for use with HF-20 and IMP-30 amplifiers described above.

## IMPERIAL 30 WATT AMPLIFIER \$29.95

### NEW 1957 MODEL

Push-Pull 6L6 Output Tubes  
Response 15-20,000 CPS  
Bass and Treble Tone Controls  
Compensated Gain for G.E. Cart.  
Input for Xtal or Dynamic Mike

With CU-14Y, 12" Coax Speaker...\$39.95  
With P15-CR, 15" Coax Speaker...\$49.95  
With Imperial IV Speaker System...\$46.95  
With SP12125CR...\$51.95 With HF-33GE...\$76.95

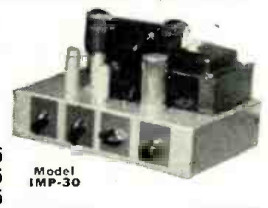

New 1957 model 7 tube Imperial 30 watt High Fidelity audio amplifier. A \$100.00 list value for only \$29.95. Features a heavy 4 lb., specially wound high fidelity output transformer with 15% inverse feedback; push-pull 6L6 output tubes and frequency response from 15 to 20,000 cps. Matches 8 or 16 ohm speakers. You can center your entire custom music system around this low cost 30 watt amplifier. This Imperial 30, 30 watt amplifier may be used with any radio tuner or record player. It will drive any speaker system that you may have. Use from one to ten 8" speakers or any 12" or 15" coaxial speaker or any 3-way speaker system. Tone compensated input for either a crystal phono pickup or a General Electric variable reluctance pickup. Also, has input for crystal or high impedance dynamic microphone. 4 controls are mike gain, phono gain, treble tone and bass boost tone control. This amplifier weighs 21 lbs. net. Full size transformer components would cost you up to \$15.00 if purchased separately. Gold color chassis is 12 1/2" x 7 3/4" x 7 3/4" high. Complete with tubes: 6AT6, 12AU7, 6CA, 12AU7, 2-6L6GA plus 5U4G rectifier. Stock No. IMP-30, 30 watt Imperial High-Fidelity amplifier complete with tubes and diagram. Ship. wt. 23 lbs. Sale price only \$29.95.

## 25 WATT HI-FI SPEAKER SYSTEM

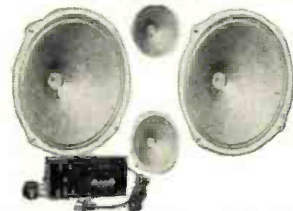

2-12" Woofers  
2-5" Tweeters  
Power Supply  
and L-C Cross-  
over Network  
**\$24.95**

25 watt, High-Fidelity Dynamic Speaker System, complete with 2000 cycle genuine inductance-capacitance crossover network, two 12" woofer speakers, two 5" high frequency tweeter speakers and separate 110 volt AC power supply for only \$24.95. Frequency response 20 to 15,000 cps. Both the woofers and the tweeters are fine quality dynamic speakers with fields excited to saturation by the power supply. Tweeters are specially made with cones designed to respond only to the high frequencies of the audio spectrum. The 2000 cycle cross-over network is of the high quality inductance-capacitance type which prevents frequencies below 2000 cps from entering the tweeters and eliminates frequencies above 2000 cps from the woofer circuit. The cross-over network system is simple to connect to any 4 or 8 ohm output of your high fidelity audio amplifier or radio. No. SP-12125CR, High Fidelity Dynamic Speaker System. Ship. wt. 15 lbs. Sale price, \$24.95. No. SP-12125, High Fidelity Dynamic Speaker System, as described above, but less the 2000 cycle cross-over network and with a separate attenuator control. Sale price, \$14.95. Ideal for use with HF-20 and IMP-30 amplifiers described above.

## AIR KING FM-AM TUNER

SELF POWERED  
Use with any  
Audio Amplifier  
**\$24.99**

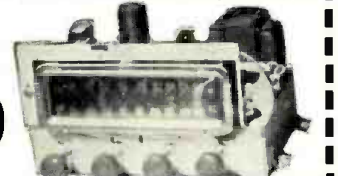

Air King factory built, 6 tubes self-powered FM-AM radio tuner. Receives broadcast 540 to 1620 kc and FM 88 to 108 mc. Use with any Hi-Fi audio amplifier or connect it to your TV set for FM-AM reception. Selector switch has 4 positions for TV-Phono-FM and AM. 3 other controls are volume-on-off, tone and tuning. With tubes: 12AX7, 2-6AL5, 6AL5, 5Y3, and 5Y3 rectifier. Chassis size: 11 1/2" x 7 1/2" x 6 1/2" high. Illuminated slide rule dial 7 1/2" x 2 1/2" with excitephon tuner and knobs. Self-powered with its own power transformer. Air King FM-AM tuner chassis No. 703 as used in Air King model 17K1C combination TV-Radio-Phono with power supply added. Note: A separate audio amplifier is required to operate a speaker. Stock No. AIR-KG, self-powered FM-AM tuner, complete with tubes, knobs and diagram. Ship. wt. 10 lbs. Sale price, \$24.99.

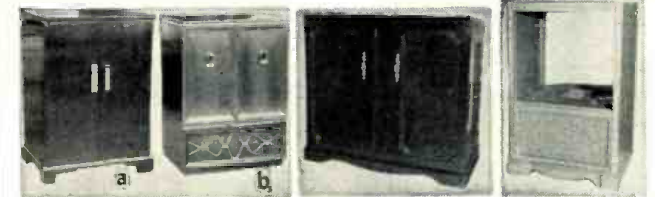

\$59.95 \$59.95 NRT-21M \$59.95 BT-210 \$22.95

(a) No. 27-MA. Mahogany Full Door Cab. \$59.95  
27" Mahogany Full Door Cab. \$59.95  
(b) No. 27-34MA. Mahogany with 3/4 doors for 21", 24" and 27" sets. 43" h. 31 1/4" w. 22 1/2" deep. Chassis area 27 1/2" x 26 3/4" h. 21" deep. Baffle cut for 21" speakers. Made for one of America's largest TV builders. Cost over \$100. Ship. wt. 135 lbs. Sale price, \$59.95. Blank panel \$5.00 extra. Shipped with 27" mask and safety glass.  
27" 3/4 Door Mahogany Cab. \$59.95  
(b) No. 27-34MA. Mahogany with 3/4 doors for 21", 24" and 27" sets. 43" h. 31 1/4" w. 22 1/2" deep. Chassis area 27 1/2" x 26 3/4" h. 21" deep. Baffle cut for 21" speakers. Made for one of America's largest TV builders. Cost over \$100. Ship. wt. 135 lbs. Sale price, \$59.95. Blank panel \$5.00 extra. Shipped with 27" mask and safety glass.

## DELUXE 21" MAHOGANY TV-PHONO CABINET

No. NRT-21M. Deluxe piano finish mahogany combination radio-phono-TV cabinet for 20" or 21" TV chassis. Beautiful full door style with matching front panels. TV chassis area 20 1/2" high, 23 1/2" wide and 18 1/2" deep. Baffle cut for 10" speaker. Area 21" high, 23 1/2" wide and 19" deep. Changer shelf 15" x 17" with 9" height clearance. Ship. wt. 165 lbs. No. NRT-21M, mahogany cabinet, sale price, \$59.95. 21" mask and safety glass, \$6.95 extra.

## 21" BLONDE \$22.95—MAHOGANY OR WALNUT \$19.95

No. BT-210, blonde oak 21" TV cabinet. 37 1/2" high, 24" wide and 20 1/2" deep. Ship. wt. 68 lbs. Sale price, \$22.95.  
No. WT-210, walnut 21" TV cabinet, same as above. Sale price, \$19.95.  
No. MT-210, mahogany 21" TV cabinet, same as above. Sale price, \$19.95.

# McGEE RADIO COMPANY

PRICES F.O.B. KANSAS CITY TELEPHONE VICTOR 2-5092  
SEND 25% OR FULL REMITTANCE WITH ORDER. 1903 MCGEE ST., KANSAS CITY, MISSOURI  
BAL. SENT C.O.D.





# TV Receivers

## Now Use Selenium Diodes

By T. P. CLEMENTS and HUGH S. WYETH

Admiral Corporation Service Division

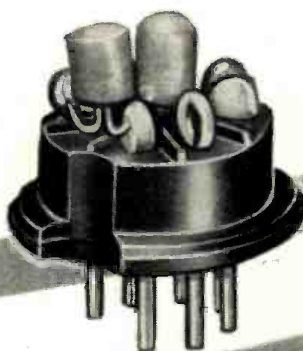
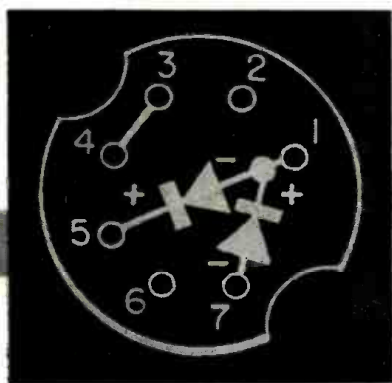

Fig. 1. The two small International Rectifier Corp. selenium diodes on the tube base at the left replace the 3AL5 in a TV sync discriminator circuit. The diagram shows wiring details.

*Cheaper and more reliable than vacuum tubes for some applications, more and more of these units are destined to be used in TV sets. Here is operating and test data.*

THE progressive development of selenium diodes has resulted in their replacing tubes not only in power supplies, but in other circuits as well. One new application in TV receivers is the use of a pair of subminiature selenium diodes as a horizontal sync phase discriminator instead of the duo-diode tube previously used in this circuit.

Admiral first used these new subminiature selenium diodes in its 17X3 series chassis for 1956 17-inch models. Originally, this chassis used a 3AL5 duo-diode receiver tube as a horizontal sync phase discriminator, but this tube has been replaced by the plug-in unit with two selenium diodes, shown in Fig. 1. These diodes are manufactured by the International Rectifier Corporation. In later Admiral chassis the selenium duo-diode is wired onto the automation-produced printed-wiring boards.

At first, the selenium diodes were wired to a tube base so their advantages could be obtained without waiting for the redesign of the printed-wiring board, and to allow a 3AL5 tube to be used as a service replacement in this socket until subminiature seleniums become more easily available to television service technicians. Strangely enough, some service technicians thought that the factory had left some sort of test plug in the socket and promptly replaced the selenium duo-diode with a tube.

What advantage is there in using subminiature selenium diodes instead of tubes? The subminiature seleniums cost much less than a duo-diode vacuum tube, are much smaller in size, do not require any heater power, and are more reliable. They also cost less than germanium diodes. When circuit requirements do not exceed the capabilities of selenium diodes, there is every advantage in using them, and undoubtedly they will be used more and more in television receivers.

Subminiature selenium diodes are potted in a thermosetting compound to protect them from moisture, corrosive atmosphere, and fungus. They will operate in temperatures as cold as the

Fig. 2. Static characteristics of the International Rectifier Corp. type 1U1 subminiature selenium diode. See text.

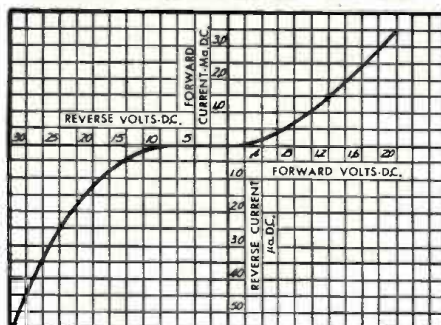

RATED FORWARD CURRENT = 1.5 ma.  
MAXIMUM APPLIED VOLTAGE = 26 v. r.m.s.  
MAXIMUM D.C. OUTPUT VOLTAGE = 20 v.  
PEAK INVERSE VOLTAGE = 60 v.

North Pole and as hot as boiling water. Aside from their application as horizontal sync phase discriminators in television receivers, they are used for bias supplies, power supplies for sensitive relays, in computers, and in many other circuits.

Their electrical characteristics are similar to those of germanium diodes with which the television service technician is already familiar. Like germanium diodes, they have a slight reverse current. The characteristics of a typical subminiature selenium diode are illustrated in Fig. 2.

Selenium diodes will not replace either tubes or germanium diodes in all applications. The reverse current of selenium and germanium diodes often disqualifies them for some applications. The capacity of selenium diodes is another limitation, for their shunt capacitance is greater than that of either a germanium or vacuum tube diode. The somewhat higher shunt capacity of selenium diodes limits their use to circuits which handle signal frequencies below 100 kc. Their operation in circuits like the horizontal sync phase discriminator is very satisfactory. How they function here can be explained by referring to Fig. 3.

In Fig. 3 is shown the horizontal sync phase discriminator circuit used in 1956 Admiral TV receivers. The function of this circuit is to generate a correcting voltage for the horizontal oscillator if the latter's frequency is incorrect. If the grid voltage of the horizontal oscillator tube is made less negative, the oscillator frequency will increase; if the grid voltage is made more negative, the frequency will decrease. The horizontal sync discriminator compares a sample of the hori-

zontal oscillator output with the frequency and phase of the incoming horizontal sync pulses and then develops a correction voltage that will speed up or slow down the horizontal oscillator, keeping it in exact synchronization with the received sync pulses.

From the sync inverter tube,  $V_{401}$ , which serves as a phase splitter, positive-going horizontal sync pulses are applied to the anode of diode 1 and negative-going sync pulses of equal amplitude are applied to the cathode of diode 2. Both diodes will conduct during the time of each horizontal sync pulse. If both diodes conduct equally, the voltage drops across resistors  $R_{127}$  and  $R_{128}$  will be equal. Under this condition of normal operation, there will be no d.c. voltage across  $R_{129}$  and no correction voltage applied to the horizontal oscillator tube grid.

A saw-tooth waveform is coupled from the horizontal deflection circuit to the cathode of diode 1 and the anode of diode 2. If the horizontal oscillator frequency and phase are correct, this saw-tooth voltage will be passing through zero at the same time the horizontal sync pulses arrive, the diodes will conduct equally, and no correction voltage will be developed. However, if the oscillator frequency should change, the horizontal saw-tooth voltage will not be passing through zero at the time the sync pulses arrive and, as a result, the total voltage across each diode will differ. This will result in unequal conduction of the diodes, the voltage across resistors  $R_{127}$  and  $R_{128}$  will be unequal, and there will be a d.c. voltage across the common load resistor,  $R_{129}$ . This d.c. voltage will be applied to the grid of the horizontal oscillator to bring it back to the correct frequency and phase for perfect synchronization.

What trouble symptoms will be caused by an open or shorted selenium diode in this circuit? Failure of either diode will cause complete loss of horizontal sync or "touchy" horizontal sync. If this symptom exists, there are two ways of determining whether the selenium diode is good or not. One way is to check the resistance of the diode with an ohmmeter. In the circuit of Fig. 3, it is unnecessary to disconnect the diodes when making ohmmeter checks because of the relatively high shunting resistance. With the ohmmeter leads connected one way the resistance will be 2000 ohms or less; with the leads reversed the resistance will be many thousands of ohms. The exact resistance measured will vary considerably depending on the ohmmeter and the scale used, but the resistance reading in one direction should be at least ten times greater than in the reverse direction.

Ohmmeter resistance readings can only be used as a rough check of selenium (or germanium) diodes because the indicated resistance will depend on the voltage applied to the diode by the ohmmeter. This can be understood by examining the static

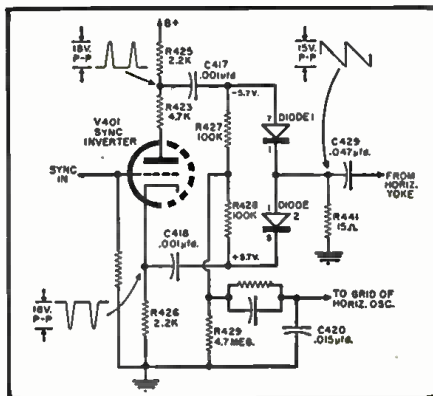

Fig. 3. Horizontal sync phase discriminator circuit used in the Admiral 17X3 series TV chassis. Originally the two subminiature selenium diodes were inserted on a tube base but now they are wired directly onto the printed circuit.

characteristics of the selenium diode in Fig. 2. For instance, if the ohmmeter should apply 1.5 volts to the diode the low, or forward, resistance will be about 750 ohms, while if the ohmmeter applies only .5 volt across the diode, the indicated resistance will be about 2000 ohms.

Another and perhaps better method to determine if the selenium diodes are OK or not is to first check the voltages in the circuit where they are used. For example, in Fig. 3, if one of the diodes is either shorted or open, the picture will be far out of horizontal sync, but the vertical sync will be OK. With no signal being received, the voltage at the anode of diode 1 should be from 5 to 7 volts negative with respect to the chassis, and the voltage at the cathode of diode 2 should be from 5 to 7 volts positive. If these voltages are correct, the selenium diodes are OK, and the trouble must be somewhere else. If these voltages are incorrect, chances are that  $C_{127}$ ,  $C_{128}$ , or  $C_{129}$  are leaky, the horizontal oscillator tube is defective,  $R_{127}$  and  $R_{128}$  are not equal in value, or, finally that one or both diodes are faulty.

If both voltages are positive, it is likely that  $C_{117}$  is leaky.  $C_{117}$  can be checked for leakage by shorting the junction of  $R_{125}$  and  $R_{128}$  to the chassis; if the capacitor is leaky the voltage at the anode of diode 1 will change. If shorting  $R_{128}$  changes the cathode voltage of diode 2,  $C_{118}$  is leaky. If there is a positive voltage at the junction of  $R_{141}$  and  $C_{129}$ , then  $C_{129}$  is leaky. The horizontal oscillator tube can be eliminated as the cause of the incorrect voltages by shorting  $C_{130}$ .

In addition to the subminiature selenium diodes of the kind used in Admiral television receivers, a wide variety of other types are available. They are furnished for output voltages of from 20 to 160 volts and output currents of from 100 microamperes to 11 milliamperes. The small size of these subminiature diodes, their low cost, and their convenient electrical and physical characteristics will surely result in subminiature seleniums becoming a common sight to television and electronic technicians.

Your choice of school is highly important to your career in



INDUSTRIAL ELECTRONICS



RADIO



TELEVISION

Become an  
**ELECTRICAL ENGINEER**  
or an  
**ENGINEERING TECHNICIAN**  
at

**MSOE in Milwaukee**

Choose from courses in:

**ELECTRICAL ENGINEERING**  
Bachelor of Science degree in 36 to 42 months with a major in electronics or electrical power.

**ELECTRICAL TECHNOLOGY**  
Engineering Technician certificate in 12 months in electronics, radio, or electrical power;

Associate in Applied Science degree in 18 months in radio and television.

**TECHNICAL SERVICE**

Service certificate in 6 months in electricity; in 12 months in radio and television.

MSOE — located in Milwaukee, one of America's largest industrial centers — is a national leader in electronics instruction — with complete facilities, including the latest laboratory equipment, visual aid theater, amateur radio transmitter — offers 93 subjects in electrical engineering, electronics, radio, television, electrical power, and electricity.

Advisory committee of leading industrialists. Courses approved for veterans. Over 50,000 former students.

Excellent placement record.

TERMS OPEN SEPTEMBER, JANUARY, APRIL, JULY

Choose wisely — your future depends on it. Write for more information today!



**MILWAUKEE**

SCHOOL OF ENGINEERING  
Dept. RN-756 1025 N. Milwaukee St.  
Milwaukee 1, Wisconsin

Send FREE career booklets on:  
 Electrical Engineering  Radio-Television

I am interested in..... (Name of course)

Name..... Age.....

Address.....

City..... Zone..... State.....

If veteran, give discharge date..... MS-31

GET INTO ONE OF THESE  
TOP OPPORTUNITY FIELDS

# ELECTRICITY

- Electronics or  
**TELEVISION**  
- Radio-Color TV

TRAIN IN THE GREAT SHOPS OF

## COYNE

OLDEST, BEST EQUIPPED  
SCHOOL OF ITS KIND IN U. S.

**Veterans and Non-Veterans**—Prepare for a better job NOW that offers a real future, too! Get practical training in TELEVISION—RADIO—ELECTRICITY—ELECTRONICS—(Refrigeration & Electric Appliance Repair can be included). Learn on real equipment—no advanced education or previous experience needed. Lifetime employment service to graduates.

**Finance Plan**—enroll now, pay most of tuition later. Part time employment help to students.

**FREE BOOK** Clip coupon for Big Free Illustrated Book. No salesman will call. Act NOW.

B. W. COOKE President **COYNE** FOUNDED 1899  
**ELECTRICAL SCHOOL**

A TECHNICAL TRADE INSTITUTE OPERATED  
NOT FOR PROFIT  
500 S. PAULINA ST., CHICAGO, Dept. B6-85H  
ELECTRICITY • TELEVISION • RADIO • REFRIGERATION • ELECTRONICS

B. W. COOKE, Pres., COYNE ELECTRICAL School  
500 S. Paulina St., Chicago 12, Ill., Dept. B6-85H

Send FREE BOOK and details on:

- TELEVISION-RADIO  
 ELECTRICITY-ELECTRONICS

NAME.....

ADDRESS.....

CITY..... STATE.....

always buy  
**RAD-TEL**  
for HIGHEST QUALITY  
**TUBES**  
at lowest prices

SAME DAY SERVICE. FULL 1 YEAR GUARANTEE.  
ALL TUBES QUALITY BOXED. FOR QUALITY,  
PERFORMANCE, DEPENDABILITY.

Another Rad-Tel Super-Special!  
**5FP7 CATHODE RAY TUBE**

Magnetic focus and deflection. 53° deflection angle, neck diameter 1 3/8 inch. Base shell metal 8-pin. Special features: long persistence for either low speed non-recurring signals or high speed recurring signals; two or more signals can be observed with suitable switching. Mfd. by RCA. single 95¢ ea. Lots of 3

79¢

CLOSE OUT! RT-24/APX-2 IFF EQUIPMENT

Brand new 44 tube transceiver—government unit—In sealed overseas carton.

Contains:  
11-8AG5 1-5Y3  
19-6C4 1-2C26  
7-6J6 1-2D21  
1-0D3/VR105 4-9006

Also, these useable parts: tube sockets, relays, coax fittings, condensers, resistors, etc. 24-volt blower motor, gear train motor, power transformer 400 to 2400 cycles.

Lots of 3, \$12.95 ea.

Single unit, \$13.95

Imagine—list price on tubes alone is \$81! All tubes are tested, passed and branded RCA, National Union, Sylvania, etc. PLUS the parts listed—what value!

FREE Tube & Parts Catalog Listing Over 400

High Quality Tube Types. Write Dept. RN-7

EXPORT INQUIRIES INVITED

TERMS: 25% deposit must accompany all orders—balance C.O.D. All shipments F.O.B. Irvington warehouse.

**Rad Tel**  
TUBE CO.

Not Affil. With  
Any Other  
Tube Mail  
Order Co.

115 COIT ST., IRVINGTON II, N. J.

# What's

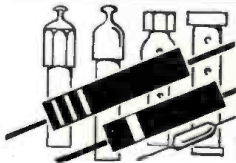

# New in Radio

## BIKE RADIO

*Silver Bells, Ltd.*, 3367 Fernside Boulevard, Alameda, California is handling the U. S. distribution of a novel German-built bicycle radio.

The four-tube set covers the range from 510 to 1625 kc. It is housed in a



colorful unbreakable cabinet with permanent dynamic speaker. A telescoping antenna extends to 30 inches. A special key prevents tampering with the receiver. Battery life is at least 100 hours.

For information and prices on this AWB bicycle receiver write to Peter J. Wangoe in care of the distributor.

## SELENIUM RECTIFIER TESTER

*Winston Electronics, Inc.*, 4312 Main Street, Philadelphia 27, Pa. is now offering its Model 610 dynamic selenium rectifier tester, an instrument incorporating dynamic pulsing to test the rectifier under actual load conditions.

A flashing red light acts as a monitor to show the pulsing action. Rectifier quality as well as shorts, leakage, and open circuit conditions are indicated on the multi-color "Good-Bad" scale of the meter. Fixed resistor loads avoid instrument burn-outs and



give increased accuracy. Five fixed resistor loads are calibrated to test rectifiers from 20 ma. to 1000 ma.

## CRYSTAL PHOTOCCELL

*Clairex Corporation*, 50 West 26th Street, New York 10, New York, has developed a new photoconductive cell which is extremely sensitive to the red and near infrared region of the spectrum.

Of polycrystalline cadmium selenide,

the new unit has a small time constant and a very high ratio of dark-to-light resistance. The sensitivity element of the CL-3 has a rectangular area of approximately 1/16" x 3/16". The sensitive area is 1/8" from one end of an epoxy resin cylinder 1/4" in diameter and 1/2" long.

Write the company direct for a copy of the data sheet covering the CL-3.

## HEATH CRYSTAL RECEIVER

An interesting project for the beginner is the new crystal receiver kit just released by *The Heath Company*, Benton Harbor, Michigan.

The CR-1 covers the band from 540 to 1600 kc. It has two high "Q" tank circuits that employ ferrite-core coils and conventional air tuning capacitors. The capacitors are tuned individually to the desired stations.

The receiver is housed in a black Bakelite case. It uses a sealed ger-



manium diode for detection. The kit includes a pair of high-impedance headphones, instead of the usual single headphone. The company suggests that the set could also be used as an AM tuner in hi-fi applications.

In addition to step-by-step assembly instructions and pictorial diagrams, the construction manual provides the kit builder with the basic fundamentals of signal reception.

## TRANSISTORIZED MIXER-AMP.

*Baird Associates*, 33 University Road, Cambridge 38, Mass., is now offering a new transistorized mixer amplifier, the Model JG2.

Designed especially for remote-pick-up recordings, outside p.a. systems, and "on-the-spot" interviews, the Model JG2 is entirely self-contained including a 13-volt power supply which can operate with a wide variety of standard mercury cells. The batteries are housed in specially designed, spring-loaded holders that facilitate rapid replacement in the field.

The circuit consists of two, low-noise preamp stages, one low-noise mixer stage, one amplifier stage, and one output stage. Junction transistors of the

RADIO & TELEVISION NEWS

*p-n-p* type are used in all stages except the amplifier or driver stage. The driver stage uses *n-p-n* transistors.

Complete specifications on this mixer amplifier are available from the manufacturer on request.

#### MAGNETIC SHIELD TEST KIT

The Magnetic Shield Division of *Perfection Mica Company*, 20 N. Wacker Drive, Chicago 6, Illinois is now offering a multi-purpose magnetic shield testing kit which uses the company's recently developed shielding material.

The shielding material in the kit is designed for a wide variety of applica-



tions including (1) flat shielding sheets capable of being formed into many shapes to shield motors, deckplates, turntables, etc.; (2) transformer can shields in various sizes to attenuate hum, prevent coupling from solenoid to solenoid and to prevent scope beam distortion resulting from the transformer (a combination high-low intensity shield is used); and (3) rectangular memory tube storage container shield using a combination of high and low intensity shields. In addition, the kit contains box-shape tape container shields for preserving recording tape and for numerous evaluation tests, CR tube combination shields for high and low attenuation, magnetron storage and shipping container shields, and miscellaneous high or low attenuation shields for other experimental and evaluation purposes.

#### NEW G-E TRANSISTORS

*General Electric Company*, Electronics Park, Syracuse, New York has announced the availability of three new inexpensive transistors which have been designed especially for high-fidelity amplifier or broadcast receiver applications.

The new transistors, all *p-n-p* types, include six different types for the output stage of an audio amplifier and four types for the driver stage. The units have been designated as the 2N186A, 2N187A, 2N188A, 2N186, 2N187, 2N188, 2N189, 2N190, 2N191, and 2N192.

The Semiconductor Products Division of the company will supply additional details on request.

#### TINY DIELECTRIC TRIMMERS

Three new miniature air dielectric trimmer capacitors, said to be the smallest ever produced in the U. S., have been introduced by *Radio Condenser Company*, Davis & Copewood Streets, Camden, New Jersey.

Designated as the "subminiature

# IBM WANTS ENGINEERS AND TECHNICIANS FOR PROJECT SAGE

*(Continental air defense for  
165,000,000 Americans)*

Project SAGE, America's air defense warning system, offers opportunities to challenge your ability. Equipped with more than 50,000 vacuum tubes, the SAGE computer is the result of the most advanced electronic concepts. Make your own career with SAGE, and the world's largest computer.

## SYSTEMS ENGINEERS

You will be responsible for the performance, evaluation, reliability testing, and maintenance of the entire system.

**Requirement:** Degree or equivalent with emphasis in electronics.

## FIELD TECHNICIANS

Actual maintenance and component analysis. Assume high-level responsibility.

**Requirement:** Two-year technical school training in electronics, or equivalent.

## NOW is the time to investigate

- Permanent Employment
- Training at Full Salary
- Full Employee Benefits
- Relocation Expense Allowance

## Assignments in:

- Portland, Me.
- Richmond, Va.
- Syracuse, N. Y.

## ... and other desirable locations

Write, giving details of education and experience, to:  
Nelson O. Heyer, IBM, Room 4307,  
Military Products Division, Kingston, New York

INTERNATIONAL  
BUSINESS MACHINES  
CORPORATION

DATA PROCESSING  
ELECTRIC TYPEWRITERS  
TIME EQUIPMENT  
MILITARY PRODUCTS

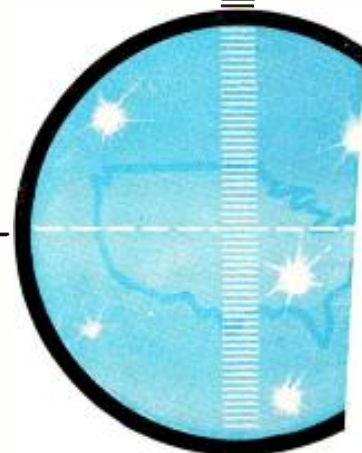

# ACROSOUND TRANSFORMERS

## FOR THE ULTIMATE IN HIGH FIDELITY AMPLIFICATION

World-famous Acrosound transformers are manufactured under rigid quality standards prescribed by Keroes Enterprises. Each transformer is tapped at the optimum location for best Ultra-Linear performance. As a result, lows are more articulate, transient qualities of highs are preserved and reproduced with sparkling realism. Acrosound transformers bear the black and gold "K" symbol\*—your certification of quality electronic products.

TO-300—5881, KT-66	
Ultra-Linear Wm'son. . . . .	24.75
TO-310—6V6, EL-84. . . . .	18.75
TO-320—6Y6. . . . .	18.75
TO-330—6550, PP-PAR KT-66	
EL-34 Ultra-Linear Wm'son . . . . .	39.75
TO-350—100W—	
Ultra-Linear 6146 . . . . .	49.50



Acrosound Ultra-Linear transformers feature:

- Greater bandwidth for most realistic transient response:  $\pm 1$  db, 10 CPS to 100 KC.
- Full rated power 20 CPS to 30 KC. Twice rated power 30 CPS to 20 KC.
- Correct tap location for optimum Ultra-Linear performance. Tight coupling between screen and plate winding sections.
- Low and equalized leakage reactances for maximum stable feedback.
- High primary inductance for best low frequency stability.

For the finest in sound, insist on Acrosound transformers with the black and gold "K" symbol.

\*Trademarks identifying electronic equipment meeting standards controlled and prescribed by Keroes Enterprises.



369 SHURS LANE, PHILADELPHIA 28, PENNSYLVANIA

trimmer series 75," the new units are designed for tab mounting on dip-soldered printed wiring boards or screw-mounting on conventional chas-

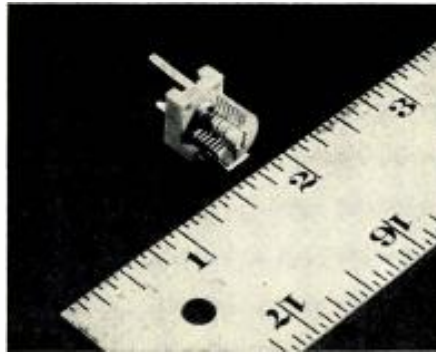

sis. The new units measure just  $2\frac{3}{64}$ " x  $\frac{7}{16}$ " x  $1\frac{1}{32}$ " behind the mounting surface.

The capacitors have a minimum effective capacity range of 5, 10 and 15  $\mu\text{fd}$ . The nominal minimum capacity of the three units is 1.2, 1.2, and 1.5  $\mu\text{fd}$ , respectively. Complete details on the new series is contained in Engineering Bulletin TR-123, which is available from the manufacturer on request.

### TRANSISTOR OSCILLATOR

A crystal-controlled transistor oscillator has been developed by the *James Knights Company* of Sandwich, Illinois which offers a complete plug-in signal source with fixed temperature and humidity environment for transistor and circuitry elements.

Each transistor oscillator includes a special crystal, designed for the particular application, with tight angle control and tolerances. Each oscillator is individually tailored for the frequency and other parameter values of the crystal and the transistor with which it will be used.

Write the company direct for full details on specific applications.

### TV PICTURE-TUBE TESTER

*The Hickok Electrical Instrument Co.*, 10524 Dupont Avenue, Cleveland 8, Ohio has released a new cathode-ray tube tester specifically designed



for use by TV technicians and dealers, in checking the electron gun of CR tubes.

The new unit tests for both shorts and open elements in the electrodes of the electron gun through use of a sensitive neon lamp. Identified as the Model CR5 "Videochek," the instru-

ment permits a rapid determination of the condition or quality of the emitting cathode. This check uses the cathode-ray tube in conjunction with a neon lamp in a bridge circuit as a peak-reading v.t.v.m. The combination is rugged, both electrically and mechanically, and there is no sensitive meter to be damaged.

The entire instrument is housed in a metal case measuring 6" x 8 $\frac{1}{2}$ " x 3" weighing 5 pounds. The unit operates on 117 volts, 50 or 60 cycles.

### "PAGEMASTER"

The Telephone Division of *Stromberg-Carlson*, Rochester, New York is in production on the firm's "Pagemaster," a selective radio paging system.

The new unit serves to locate personnel quickly in locations or situations where conventional paging systems are undesirable or ineffective. The principal feature of "Pagemaster" is a small radio decoder, about the



size of a pack of cigarettes. Each such decoder responds to a certain coded radio signal. When it receives that signal, it emits a pleasant audible tone which is a message to the individual carrying or using that particular decoder that he is being paged. He then goes to the nearest telephone and identifies himself to the operator to receive the message.

The decoder measures 2 $\frac{1}{2}$ " x 3 $\frac{3}{8}$ " x 1" and weighs 7 ounces. It is housed in a plastic case and is completely self-contained with no external wires required. Power is supplied by a special compact power pack which will operate the decoder for several weeks. Up to 4000 channels can be handled by this system.

### CRYSTAL SETS

*Radi-Ore Labs*, 38 Oneida Street, Lynn, Mass. is now offering two versions of its "Peppy Pal" crystal receiver kit, the KFTP with an earphone and the KFT without.

The kits contain all of the necessary parts including a pre-wound antenna coil. Instructions for assembling the receiver are given in step-by-step progression.

As an interesting and simple project for the beginner, these kits offer many attractive features at low cost.

### CONSTRUCTION PROJECTS

*LMB*, 1011 Venice Blvd., Los Angeles 15, California is now offering a series of experimental projects, circuits for

which will be packed with the firm's extensive line of box chassis.

These "Kit Diagrams" are complete in detail with complete circuit diagrams, photographs, and parts lists. The projects are designed for experimenters, beginners, and hobbyists as well as for classroom instruction purposes. Only standard parts, easily procurable from any distributor, are specified in the circuitry.

The project has been launched with 10 kit diagrams with 10 new circuits to be added each three months. A list of currently available projects can be obtained from the company's distributors or from the manufacturer direct.

#### MODERATELY PRICED RECEIVER

*Hammarlund Manufacturing Co., Inc.*, 460 West 34th Street, New York, New York is now offering a moderately priced communications receiver, the HQ-140-XA.

The new model is an improved version of the company's HQ-140-X. It is housed in a functional cabinet and provides up to 2 watts of audio power output. A ruggedized yet smooth-operating tuning dial drive permits extremely accurate logging with greatly improved accuracy in the dial markings.

#### EXPERIMENTAL DESIGN KITS

*Erie Resistor Corporation*, Erie, Pa. has announced the availability of a series of experimental design kits which will enable engineers and designers to produce working breadboard prototypes and establish design centers using the company's "PAC" modular technique.

The kits are available in three models, 5%, 10%, and 20%. The 5% kit includes 145 RETMA resistor values and 50 RETMA capacitor values. The 10% kit contains 73 and 32 components, respectively, while the 20% kit has 37 and 17 items. Each value is represented by a minimum of 10 components while the more popular values contain 20 components.

(Continued on page 104)

## OPPORTUNITIES IN RESEARCH AND DEVELOPMENT OF NUCLEAR WEAPONS

if you have a trade school education or the equivalent in any of the following fields—

**ELECTRONIC FABRICATION:** for custom building of experimental circuitry from verbal instructions, schematics, sketches and specifications.

**ELECTRONIC EQUIPMENT REPAIR:** to maintain commercial electronic equipment, including oscilloscopes, data recorders, signal generators, etc.

**TRANSFORMER:** to build a wide variety of experimental transformers, working from samples and specifications.

**FABRICATION PLANNER:** to lay out and break down electronic equipment for wiring by small pilot assembly group.

Send resume to GENERAL EMPLOYMENT SECTION 568



**COMMUNICATION &  
RADAR PERSONNEL**  
*Electronic Background*

**WANTED  
NOW**

**PHILCO . . . World's  
Largest Field  
Service Organization**

... is the pioneer in the servicing of electronic equipment for BOTH industry and government. In all areas of the United States, and in nearly every section of the world, PHILCO men are at work on vital communications installations.

### **ELECTRICAL ENGINEERS and TECHNICIANS**

... at all levels and in all fields of electronics are needed for long range, challenging and really interesting assignments, guaranteed to utilize the fullest skills of men who are specialists in the Design, Maintenance and/or Instruction of others in Communication, Radar and Sonar Equipment.

Men ... who can qualify for our important projects are assured that there is no other company offering more fully paid benefits to its employees ... PLUS valuable family insurance and hospitalization programs ... PLUS top pay, special assignment bonuses and a planned, fully integrated program for merit and faithful service salary increases.

**TODAY** ... is the time to evaluate your past and present growth potential against the FUTURE. Write NOW for the PHILCO EMPLOYMENT STORY.

**PHILCO**

**TECHREP DIVISION**

22nd & Lehigh Avenue, Phila. 32, Pa.

*First In Income and Employee Benefits!*

**You Can Now Afford  
Top Quality  
Test Equipment!**

THE NEW AND VERSATILE



■ Designed for you—and at a price you can afford to pay—precision service instruments made by world-famous ADVANCE Components, Ltd. ADVANCE instruments, functionally designed and laboratory engineered, will provide many years of reliable, trouble-free performance.



**Sine and Square Wave  
AUDIO GENERATOR**

■ ADVANCE Model H-1 Audio Generator covers, in three ranges, 15 cps to 50 Kc. both sine and square waves. On sine waves, accurate to  $\pm 1\%$ ,  $\pm 1$  cycle; less than 1% distortion at 1 Kc. Output  $\pm 2$  db, 200 uv to 20 volts. On square waves, less than 3 microseconds rise time; output 400 uv to 40 volts. Only \$82.50



**RF SIGNAL GENERATOR**

■ ADVANCE Model P-1 RF Generator covers 100 Kc to 100 Mc on fundamentals in six ranges, calibrated to 1%. Output variable from 1 uv to 100 mv,  $\pm 6$  db,  $\pm 3$  uv. 3 Outputs: 75 ohms, 37 chms, 10 ohms. Audio modulation 30% at 400 cycles; AF output 0-8 volts. Only \$69.50

WRITE TODAY FOR COMPLETE SPECIFICATIONS

Sole United States Agents

FISHER RADIO SALES Co., Inc.

21-23 44th DRIVE • Long Island City 1, L. I.

All kits include a universal wiring board which employs the standard .2" grid system and will provide a means of circuit design which will closely duplicate the finished printed wiring "PAC" layout.

Write the company direct for full details on these new design kits.

**TRANSISTORIZED V.O.M.**

New London Instrument Company, New London, Conn. has developed a transistorized volt ohmmeter which is characterized by light weight and high sensitivity.

The Model 400 features a wide range of voltage and resistance measure-



ments which extend its usefulness into such fields as servo systems, computers, and low level audio. In industrial applications, it will measure the output of transducers, thermocouples, and bridges. It will also handle signals encountered in magnetic modulators, square-law crystals, and photocells.

Complete technical information on the Model 400 is available from the

company at 53 Union Street, New London.

**SOLDERLESS TERMINAL KIT**

Vaco Products Co., 317 East Ontario Street, Chicago 11, Illinois is now offering a new solderless terminal kit designed for hobbyists, amateur radio and TV set builders, hi-fi fans, TV service technicians, etc.

Kit No. 395 consists of a cutting, stripping, and crimping tool 8" long, a package of assorted terminals, a  $\frac{3}{16}$ " x 3" round blade plastic handle screwdriver, and a plastic pouch for housing all the equipment.

The kit will be handled through hardware stores and parts distributors at a special "package" price, which is below the cost of the separate items.

**REMOTE CONTROL**

Tello Corp., 342 Madison Ave., New York, N.Y. has recently introduced a remote switching device which consists of an 8 ft. cord with a unique phone-mounted switch assembly.

When the phone is used, the output of the TV set or hi-fi unit is shorted out. Volume is automatically restored when the telephone is replaced in its cradle.

**MARYLAND PHONE NET**

THE Maryland Emergency Phone Net will hold its annual picnic in Braddock Heights Park, Braddock Heights, Md. on Sunday, July 22 from 10 a.m. on.

There will be contests, ladies' and children's programs, a rummage sale, and lots of prizes.

Make reservations with C. C. Worsley, W3TYJ, 104 Northwood, Silver Spring, Md. Tickets for adults are priced at 50 cents each with children under 12 admitted free.

The fact that the Army's field radios "can take it" was amply demonstrated recently and reported to the public by Jack Eggert, a communications expert of the Army's Signal Corps Engineering Laboratories, Fort Monmouth, New Jersey. The equipment worked through a test atomic blast that burned the mannequins "operating" them to a mound of ashes. The gear stayed on the air although some were as close as 1000 feet to ground zero. Sets were found outwardly charred and battered at the bottom of fox holes, but internal parts remained sound. Modern small radio parts and shock-proofing techniques were credited with giving these sets their endurance. In the photo (left) a mannequin with a "walkie-talkie" radio slung over his back lies face down at the bottom of a fox hole just before an atomic blast at the Nevada Proving Ground. (Right) A scattered pile of ashes is all that remained of the dummy after the blast but the radio remained in perfect working order.





# "p-n-p" - "n-p-n" Oscillators

By E. G. LOUIS

An interesting circuit application using the unique properties of "p-n-p" and "n-p-n" junction transistors.



TRANSISTORS are often considered as the semiconductor amplifier equivalent of the thermionic vacuum tube and transistor-vacuum tube analogies are frequently used to discuss and explain the operation of basic transistor circuits. The analogous operation of these two amplifying devices is also used in serious circuit design work by applying the concept of "duality" to the problem of translating known vacuum tube circuits to their transistor equivalents. A circuit is considered the "dual" of another when current in one behaves like voltage in the other. In circuit design, the technique is primarily a mathematical operation and consists of considering the transistor as the dual of the vacuum tube, then translating all vacuum tube circuit parameters into their "dual" in the proposed transistor circuit. Circuit elements which have current characteristics are substituted for those with voltage characteristics; thus, a series-tuned circuit may be substituted for a parallel-resonant circuit, a capacitance for an inductance, conductance for resistance, and a current source for a voltage supply.

In a vacuum tube, electron flow is always from cathode to plate; in general, a negative-going signal applied to the grid electrode results in a decrease in plate current, with a positive-going signal giving an increase in plate current in the popular grounded-cathode circuit. With junction transistors, on the other hand, two similar, but opposite, conditions may exist, depending on the type of transistor used. With a p-n-p transistor, in the grounded-emitter circuit, a negative-going signal results in an increase in collector current, but with an n-p-n transistor, in a similar circuit, a negative-going signal results in a decrease in collector current. Similar opposite effects occur with positive-going sig-

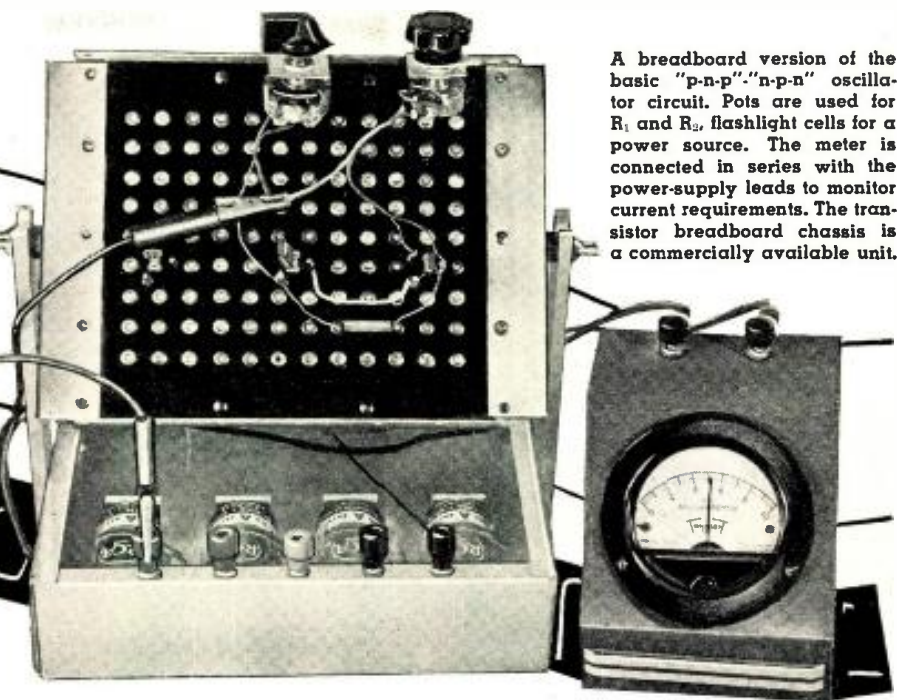

A breadboard version of the basic "p-n-p"-"n-p-n" oscillator circuit. Pots are used for  $R_1$  and  $R_2$ , flashlight cells for a power source. The meter is connected in series with the power-supply leads to monitor current requirements. The transistor breadboard chassis is a commercially available unit.

nals, which cause a decrease of collector current in a p-n-p transistor, but an increase in collector current with n-p-n units. As far as direct currents are concerned, and assuming normal supply voltage and bias operation, the current flowing through each electrode of a p-n-p unit is exactly opposite that of the current through the corresponding electrode of an n-p-n transistor.

The practical application of the opposite but symmetrical characteristics of p-n-p and n-p-n junction transistors, known as the "complementary symmetry" principle, has permitted the development of a whole class of transistor circuits for which there are no vacuum-tube equivalent or dual circuits. Two "classic" examples of the application of the complementary symmetry principle to practical circuits are given in Fig. 1. A single-ended push-pull amplifier is shown in Fig.

1A, and a simple direct-coupled amplifier in Fig. 1B.

Referring to Fig. 1A,  $C_1$  and  $C_2$  serve simply as d.c. blocking capacitors. Voltage divider  $R_1$ - $R_2$  supplies base bias current to the p-n-p transistor, while divider  $R_3$ - $R_4$  serves a similar function for the n-p-n unit. The power sources (batteries) supply d.c. operating voltages of opposite polarity to the electrodes of the two transistors. Either two separate batteries or a single tapped unit may be employed. The output load impedance,  $R_L$ , is common to the collector circuits of both transistors. For best results in a circuit of this type, the two transistors used should be "matched" so that they have similar gain and static (d.c.) characteristics.

In operation, with no signal applied to the input, the d.c. collector currents of the two transistors are equal but of opposite polarity. Hence they cancel

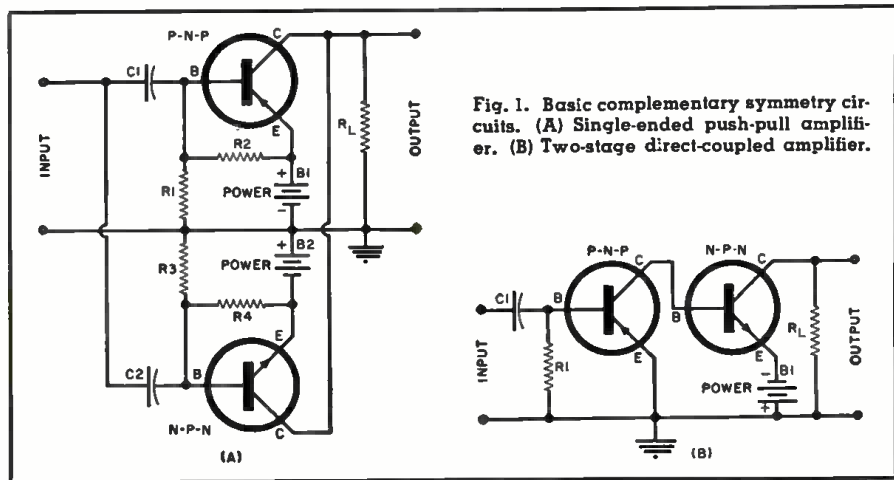

Fig. 1. Basic complementary symmetry circuits. (A) Single-ended push-pull amplifier. (B) Two-stage direct-coupled amplifier.

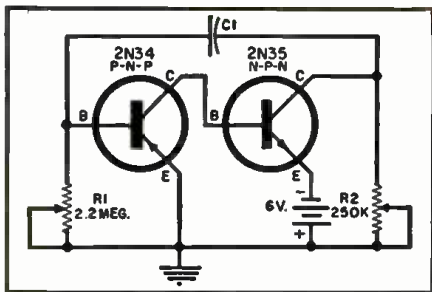

Fig. 2. The basic "p-n-p"-n-p-n oscillator circuit described in text. This is one of the simplest transistor multivibrators possible using junction-type transistors.

and there is no d.c. flowing through the load impedance  $R_L$ .

When a positive-going signal is applied to the input, through blocking capacitors  $C_1$  and  $C_2$ , the collector current of the p-n-p transistor decreases, while the collector current of the n-p-n unit increases. The two currents no longer cancel and the unbalance current flows through the load  $R_L$ . With a negative-going signal, the opposite action takes place. The collector current of the p-n-p transistor increases, while that of the n-p-n transistor decreases, again producing an unbalance current which flows through the load impedance.

Thus, the opposite but similar characteristics of the p-n-p and n-p-n transistors have been utilized in a circuit which has many of the characteristics of a true push-pull amplifier, but with a single-ended input and output. As a further feature, no d.c. flows through the load impedance ( $R_L$ ) under "zero" signal conditions, and without the use of capacitive coupling or an output transformer!

Referring to Fig. 1B, the characteristics of p-n-p and n-p-n transistors have been utilized to design a simple two-stage, direct-coupled amplifier with a single power source. As before, the input capacitor,  $C_1$ , serves simply for d.c. blocking purposes.  $R_1$  is the "base return" resistor. As shown, the first stage will act as a clipper since no base bias current flows through the p-n-p transistor. For class A amplifier operation, the lower end of  $R_1$  is returned to the negative terminal of the power source.  $R_L$  is the output load impedance. Although a resistor is shown, a transformer or impedance might be used here.

In operation, if a negative-going sig-

nal is applied to the input, through  $C_1$ , the collector current of the p-n-p transistor increases. The amplitude of the collector current change will be several times that of the input current change due to the transistor gain. But the collector current of the input p-n-p transistor is also the base current of the n-p-n transistor. Thus, an increase in the collector current of the p-n-p transistor results in an increase in the collector current of the output n-p-n transistor but, again, of much greater magnitude due to the gain of the second stage. An increase in the collector current through  $R_L$  develops a negative-going signal across this load impedance. Since this is a direct result of the application of a negative-going signal to the input, the input and output signals are in-phase. The overall gain obtained is the product of the gains obtained in each stage. As an example of the gains possible, in an experimental circuit developed by the author, using direct-coupling throughout (no input blocking capacitor), a 2 microampere change in the input resulted in a 1 milliamperere current change in the output—a current gain over 500 at d.c.!

### Basic Oscillator

Since the two-stage, direct-coupled p-n-p-n-p-n amplifier shown in Fig. 1B is capable of supplying considerable gain and, further, since the input and output signals are in-phase, it would appear a simple matter to convert this into an oscillator by coupling the input and output together. Such is the case, and the resulting multivibrator circuit, shown in Fig. 2, is perhaps the simplest multivibrator possible with junction transistors, with only three components required, other than the transistors themselves and the power source. In some cases, one of these components ( $R_1$ ) may be eliminated. Almost any type of impedance may be used for coupling the input and output, as long as d.c. levels are taken into account. For most practical work, capacitor coupling, as shown in Fig. 2, is preferred, however.

The parts values given in Fig. 2 are for a typical experimental circuit set-up employing *Sylvania* transistors, and the average experimenter should have no difficulty assembling a similar circuit for his own tests. The input base resistor ( $R_1$ ) and the output load resistor ( $R_2$ ) are variables to permit a

study of the circuit under different conditions.

In operation, capacitor  $C_1$  charges rapidly through the emitter-collector circuit of the n-p-n (2N35) transistor and the base-emitter circuit of the p-n-p (2N34) unit. The polarity of the loop current is such as to continue the action rapidly until the capacitor is fully charged, thus, the negative-going signal appearing across  $R_2$  is coupled back through  $C_1$  to the input of the p-n-p transistor. A negative-going signal here increases the transistor's collector current, thus increasing the base current of the n-p-n unit and further increasing the collector current of the n-p-n unit, continuing the charging action. Once  $C_1$  is fully charged, there can be no further increase in the negative-going signal applied to the base of the p-n-p transistor and hence the base current and collector current of this transistor drop to close to zero. A drop in the collector current of the p-n-p unit drops the base current (and hence the collector current) of the n-p-n transistor, virtually "opening" the emitter-collector circuit of the n-p-n transistor and removing the charging source (battery), permitting the capacitor to discharge slowly through  $R_2$  and  $R_1$ . The discharge of the capacitor through  $R_1$  is such as to apply a positive-going signal to the base of the p-n-p transistor, keeping both the p-n-p and n-p-n transistors "open." Collector current is close to zero.

Both transistors remain in a non-conducting state until capacitor  $C_1$  is discharged. Then the charging action resumes. The frequency of operation depends on the time constants of the RC circuits, and varying either  $C_1$ ,  $R_1$ , or  $R_2$  will shift frequency. In general, as any of these components are made smaller, the frequency of operation will increase. The output signal is a negative-going pulse, developed across  $R_2$ , with the waveshape dependent, to some extent, on the value of the components used. Typical oscilloscope patterns, as observed with a *Heathkit* Model O-9 oscilloscope, are shown in Figs. 4A, 4B, 4C, 4D, and 4E.

The patterns shown in Figs. 4A, 4B, and 4C were all obtained with  $C_1$ , equal to 0.0005  $\mu$ fd., with a total current drain ranging from 0.2 ma. to 0.6 ma. at 6 volts. Operating frequencies are 4 kc., 1.7 kc., and 1.2 kc., respectively. In general, as  $R_2$  is made smaller, the negative-going pulse narrows. No record was kept of actual resistance values, however. The waveform pattern shown in Fig. 4D is at a frequency of 3.3 kc.,  $C_1$  equal to 0.0005  $\mu$ fd.,  $R_1$  is 100,000 ohms, and  $R_2$  is 3000 ohms; total current drain is 1.0 ma. at 6 volts. The pattern shown in Fig. 4E is at a frequency of 1.1 kc.,  $C_1$  equal to 0.002  $\mu$ fd.,  $R_1$  is 100,000 ohms, and  $R_2$  is 3000 ohms; total current drain is 0.6 ma. at 6 volts.

Depending on the "back resistance" of the base-emitter circuit of the p-n-p transistor, it is sometimes possible to eliminate  $R_1$  altogether and still ob-

Fig. 3. Modification of basic oscillator circuit. (A) monostable circuit, (B) tuned oscillator, and (C) saw-tooth output.

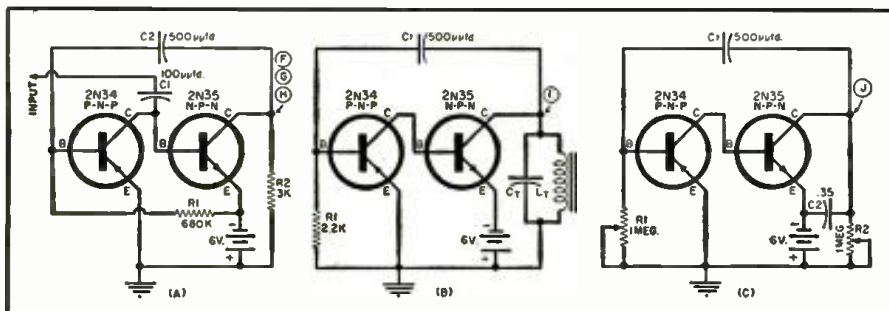

tain reliable oscillation. This results in a multivibrator with only two components, other than the transistors, load resistor  $R_2$  and coupling capacitor  $C_1$ . When this arrangement is used,  $R_1$  is simply removed from the circuit, allowing the base to "float" with no d.c. return to ground other than the internal resistance of the transistor itself.

### Circuit Modifications

An almost infinite number of variations of the basic circuit is possible, depending on the needs and requirements of the individual experimenter. Three such modifications are illustrated in Fig. 3, with the corresponding waveform patterns given in Figs. 4F, 4G, 4H, 4I, and 4J.

The circuit given in Fig. 3A is the basic circuit modified to obtain *monostable* operation. The only real change in the basic circuit is the return of the lower end of  $R_1$  to the negative side of the power source. This small change biases both transistors in a conducting state, so that the collector current through  $R_2$  is held to a maximum except when a driving signal is applied through capacitor  $C_1$ .  $C_1$  is used only for the application of a control pulse or signal, but is not essential to the operation of the circuit otherwise. With the application of a driving signal of sufficient amplitude, the circuit goes through one cycle of operation, depending on the time constant of the RC circuits, as before. A positive-going rectangular pulse appears across  $R_2$ , with a peak amplitude equal to the supply voltage, that is, 6 volts peak with the values given in Fig. 3A. The output pulses obtained with a driving signal of 500 cps and 1 kc. are shown in Figs. 4F and 4G, respectively. The appearance of the output pulse when the circuit is driven with a signal at too high a frequency for the circuit time constants is shown in Fig. 4H; an 80 kc. signal was used to obtain this pattern. Total current drain, for the circuit shown, is 2 ma., with a six volt source, and under "no signal" conditions.

Other modifications of the basic circuit are shown in Figs. 3B and 3C, with the corresponding waveform patterns shown in Figs. 4I and 4J, respectively. The circuit shown in Fig. 3B is the basic circuit with the output load resistor ( $R_2$ ) replaced by a tuned circuit,  $C_T-L_T$ . With  $C_T$  equal to 0.002  $\mu$ fd. and  $L_T$  equal to 1  $\mu$ h., the operating frequency was 7 kc.; total current drain was 1 ma. at 6 volts. The circuit given in Fig. 3C is the basic circuit with a capacitor ( $C_2$ ) connected between the collector and emitter electrodes of the *n-p-n* transistor to shape the rectangular pulse normally appearing here into a linear saw-tooth pattern, as shown in Fig. 4J. Frequency is 650 cps, current drain 0.8 ma. at 6 volts.

A general modification of any of the circuits shown is to interchange the positions of the *p-n-p* and the *n-p-n* transistors. This may be done if the

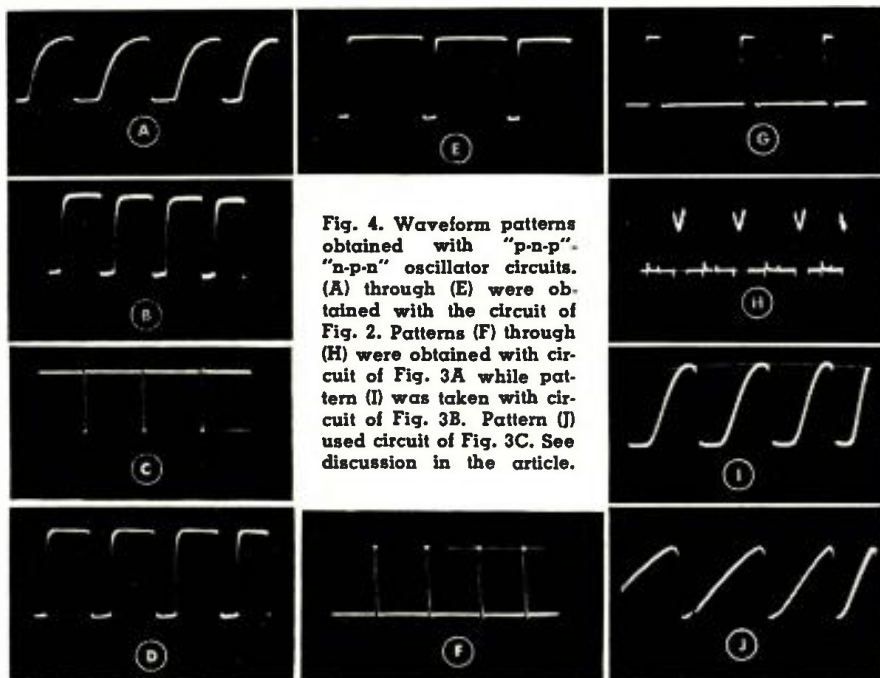

Fig. 4. Waveform patterns obtained with "p-n-p" and "n-p-n" oscillator circuits. (A) through (E) were obtained with the circuit of Fig. 2. Patterns (F) through (H) were obtained with circuit of Fig. 3A while pattern (I) was taken with circuit of Fig. 3B. Pattern (J) used circuit of Fig. 3C. See discussion in the article.

polarity of the power supply is also reversed. Circuit operation is essentially the same as before, except that all signal polarities are reversed. Thus, the basic circuit, given in Fig. 2, supplies positive-going instead of negative-going signals, and the monostable circuit, given in Fig. 3A, supplies negative-going output pulses.

### Experimental Lab Hints

All of the circuits shown are well-suited to "breadboarding" and experimental tests by hams, students, design engineers, and home experimenters alike. No difficulty should be experienced in obtaining oscillation as the circuits are completely non-critical, both as to component values and circuit layout. With the recent major reductions in the cost of transistors, components expense is almost negligible.

However, to obtain the maximum value from any experimental tests and to avoid possible components damage, the reader is cautioned to adopt a few general "rules of practice":

(1) Be sure transistors are connected in the proper manner for the battery polarities employed. Remember that different type transistors require exactly opposite d.c. operating voltages.

(2) Where possible, use adjustable components in each part of the circuit to permit minor changes in components values. Either potentiometers or resistance decade or substitution boxes may be used in place of fixed resistors, and a capacitor decade or substitution box may be used in the place of fixed capacitors.

(3) If the transistors specified in the circuits are used, do not exceed the maximum ratings of 25 volts and 10 ma. collector voltage and current, respectively. Voltages as low as 1.5 volts will give satisfactory results. To avoid exceeding the maximum current rat-

ings, it is a good idea to connect an 0-10 d.c. milliammeter in series with the battery supply leads.

(4) Use an oscilloscope to observe waveform patterns.

(5) If possible, use transistor sockets instead of soldering the transistors in place.

The reader need not restrict himself to the transistor types specified in the circuit diagrams, provided he takes care not to exceed the maximum ratings of the transistors he uses. The transistors employed need not have similar gain characteristics, as long as both *p-n-p* and *n-p-n* units are used, transistors of different manufacturers may be employed, if desired. However, a small voltage gain transistor should not be employed with a high power transistor where direct-coupling is used.

### Acknowledgements

The basic single-ended, push-pull amplifier circuit shown in Fig. 1A was adapted from *Sylvania's* booklet, "28 Uses for Junction Transistors." Some of the other circuits shown were adapted from L. E. Garner's forthcoming "Transistor Circuit Handbook" (to be published by Coyne, distributed by the Howard W. Sams organization). The transistors used for "proving out" the circuits shown were supplied by *Sylvania Electric Products Inc.* The commercial "transistor breadboard" shown in the photograph is a product of *The Electratomic Co.*, Wheaton, Md.

### BIBLIOGRAPHY

1. Sziklai, G. C.: "Symmetrical Properties of Transistors and Their Applications," *Proceedings of the IRE*, June, 1953.
2. Lohman, R. D.: "Complementary Symmetry Transistor Circuits," *Electronics*, September, 1953.
3. ———: "28 Uses for Junction Transistors," *Sylvania Electric Products Inc.*

# Completely New! DYNAKIT MARK II



An amplifier kit which provides the finest sound at low cost. The listening quality of the Dynakit is unequalled by any amplifier, regardless of price; and this kit can be readily assembled in about three hours. The Dynakit uses a new bug-free circuit, designed by David Hafler. Complete reproducibility of operating characteristics is guaranteed by the use of a factory-wired printed circuit board. The Dynakit comes complete with all components including the super-fidelity Dynaco A-430 transformer.

### Specifications:

Power Output: 50 watts continuous rating, 100 watts peak. Distortion: under 1% at 50 watts, less than 1% harmonic distortion at any frequency 20 cps to 20 kc within 1 db of maximum. Response: Plus or minus .5 db 6 cps to 60 kc. Plus or minus .1 db 20 cps to 20 kc. Square Wave Response: Essentially undistorted 20 cps to 20 kc. Sensitivity: 5 volts in for 50 watts out. Damping Factor: 15. Output Impedances: 8 and 16ohms. Tubes: 6CA7/EL-34 (2) (6550's can also be used) 6AN8, 5U4GB Size: 9" x 9" 6 1/2" high.

**69.75**  
net

# Dynaco Output Transformers



Featuring para-coupled windings, a new design principle (patents pending). These transformers use advanced pulse techniques to insure superior square wave performance and undistorted reproduction of transients. Dynaco transformers handle full rated power over the entire audio spectrum from 20 cps to 20 kc, without sharp rise in distortion at the ends of the band which characterizes most transformers. Conservatively rated and guaranteed to handle double nominal power from 30 cps to 15 kc without loss of performance capabilities.

### Specifications:

Response: Plus or minus 1 db 6 cps to 60 kc. Power Curve: Within 1 db 20 cps to 20 kc. Square Wave Response: No ringing or distortion from 20 cps to 20 kc. Permissible Feedback: 30 db.

### MODELS

A-410	10 watts	6V6, EL-84	14.95
A-420	25 watts	KT-66, 5881, EL-34	19.95
A-430	50 watts	6550, EL-34 (6CA7)	29.95
A-440	100 watts	6550	39.95

(all with tapped primaries except A-440 which has tertiary for screen or cathode feedback)

Additional data on Dynakit and Dynaco components available on request including circuit data for modernization of Williamson-type amplifiers to 50 watts of output and other applications of Dynaco transformers.

## DYNA COMPANY

Dept. RT 5142 Master St.  
Phila. 31, Pa.

# New Tube Tester Data

Keep your Triplett and Jackson tube testers up-to-date for the new radio and TV tubes.

### TRIPLETT MODEL 3423

Tube Type	A Cir	Knobs B Fil	CDEFG Load	Lever Position Up Down	Meter Reads
2B7 Test 2	2.5	76	10046	7 16	Good
2W3	2.5	32	30046	8 2	Good
2X2 (879)	2.5	37	600X6	1 4	Good
2X2A	2.5	37	600X6	1 4	Good
6AJ4	6.3	11	51052	8 127	6500
Put special-normal switch in special position 3, 4, 6, 9, also show short					
6BH8	6.3	33	52033	4 125	2145
6BH8 Test 2	6.3	17	57892	4 567	4200
6BL4	6.3	13	60056	7 38	Good
(Pins 1 & 5 also show short)					
6BQ6GA	6.3	75	50046	2 3578	Good
6BQ6GT	6.3	26	354Y3	7 258	3380
6BW4	6.3	60	10076	4 59	Good
6BW4 Test 2	6.3	60	10016	4 59	Good
CK 5694	6.3	44	64034	2 147	1040
CK 5694 Test 2	6.3	44	65064	2 578	1040
CK 5785	1.4	90	10016	6 7	Good
6085 (E80CC)	6.3	37	67063	9 4578	1855
6085 (E80CC) T2	6.3	37	62013	9 2345	1855
6086 (18042)	19.6	18	52162	4 2359	5330
9005	2.5	65	10046	1 367	Good

### JACKSON MODEL 49

Tube	Section	A	B	C	D	Cath. Shorts	E
3B2	D	3.0	2	13568	0	...	60
3CE5	P	3.0	3	7X	156	2	30
3DT6	P	3.0	3	X	1567	2	30
4BS8	T	4.2	4	X	12	3	30
	T	4.2	4	X	67	8	30
5AS4	D	5.0	2	...	4	...	12
	D	5.0	2	...	6	...	10
5BR8	P	5.0	4	X	679	8	30
	T	5.0	4	X	12	3	30
5BT8	P	5.0	4	X	678	9	30
	D	5.0	4	...	1X	3	47
	D	5.0	4	...	2X	3	47
5V3	D	5.0	2	...	4	...	10
	D	5.0	2	...	6	...	8
6BE8	P	6.3	4	X	679	8	32
	T	6.3	4	X	12	3	32
6BH8	P	6.3	4	X	789	6	31
	T	6.3	4	X	23	6	31
6BJ8	T	6.3	4	...	78	9	7
	D	6.3	4	...	1X	2	47
	D	6.3	4	...	6X	3	47
6BL4	D	6.3	7	1246	5	3	4
6BR8	P	6.3	4	X	679	8	30
	T	6.3	4	X	12	3	30
6BS8	T	6.3	4	X	12	3	30
	T	6.3	4	X	67	8	30
6BT8	P	6.3	4	X	678	9	30
	D	6.3	4	...	1X	3	47
	D	6.3	4	...	2X	3	47
6BW4	D	6.3	4	...	1	9	16
	D	6.3	4	...	7	9	16
6CE5	P	6.3	3	7X	156	2	30
6CH7	T	6.3	4	9X	12	3	30
	T	6.3	4	9X	67	8	30
6CL5	P	6.3	2	134	580	6	4
6CU5	P	6.3	3	5	267	1	4
6DN6	P	6.3	2	...	580	3	4
6DQ6	P	6.3	2	...	450	8	4
6DT6	P	6.3	3	X	1567	2	30
12BW4	D	12.6	4	...	1	9	16
	D	12.6	4	...	7	9	16
12CU5	P	12.6	3	5	267	1	4
12DQ6	P	12.6	2	...	450	8	4
19AQ5	P	19.0	3	7	156	2	8
25DQ6	P	25.0	2	...	450	8	4
X-155	T	6.3	4	X	12	3	30
	T	6.3	4	X	67	8	30

## Certified Record Revue

(Continued from page 58)

will find interesting and attractive. Not the least of these attractions is the common denominator of all Tchaikovsky scores . . . the essential lyricism and the melodic resources. The melodic line here is subdued, but nonetheless contributes much to the beauty of the score. The 4th and last movement of the "Suite" is as famous as the first three movements are obscure . . . the well-known much played "Theme and Variations." This reading by Boult is well thought out and moves along with judicious tempi. The sound also adds to the attractions of the disc, with the strings especially noteworthy for their smooth projection. Both sound and performance-wise this recording is infinitely superior to the Goehr version on a *Concert Hall Society* disc, the only other recording in the catalogue. Recommended.

### BACH FOR PERCUSSION

New York Percussion Ensemble conducted by Harold Glick. Audio Fidelity APLP1812. RIAA curve. Price \$4.98.

If you think the title of this disc is confusing, wait until you hear it! A gent named John Klein, a very versatile fellow who has composed quite a number of classical works and who has arranged music on shows like the "Hit Parade" and "Stop the Music," has transcribed three of Bach's great organ works for percussion! The "Tocatta and Fugue in D Minor," the great "G Minor Fugue" and the "Tocatta in F Major" get the treatment and the results are quite unlike anything you've ever heard. There will be many who will dismiss this as utter nonsense. Others,

like the hi-fanatic will greatly enjoy it from the aspects of sound alone, and undoubtedly many serious musicians and musicologists will appreciate the ingenuity of the structure and scoring and the remarkable percussive textures Mr. Klein achieves. If you listen closely, the rhythmic patterns of the Bach works are easily discernible. Probably the biggest sales will be to the hi-fi nut who wants to really gorge himself on percussion and transients. Among the instruments that are heard with superb fidelity are tympani, bass drum, snare drum, claves, woodblocks, tambourine, small and African tom-toms, bongo drums, tam tam, boombams, triangles, cymbals, finger cymbals, conga drums, timbales, cowbells, etc., etc. Whew!

### BERLIOZ FAMOUS OVERTURES

L'Orchestre de la Societe des Concerts du Conservatoire de Paris conducted by Albert Wolff. London LL1297. RIAA curve. Price \$3.98.

There will be people who pity conductor Albert Wolff because the poor man never seems to be able to record anything but warhorses. On the other hand, you can hardly blame London for this state of affairs, because everything Wolff has done for them, he has done so well that the records are best sellers. Wolff seems to have a peculiar knack of taking even the lowliest potboiler and giving it a new enough twist to make it newly interesting. Of course, the fact that he has also received some of London's very best recorded sound doesn't hurt matters! Here we find him holding forth with Berlioz overtures; "Le Corsaire," "Les Francs-Juges," "Le Roi Lear" and "Roman Carnival." While no match for Berlioz champions like Beecham and others, his readings are more than accept-

able. No feet dragging here . . . all are nicely paced with brisk, spirited tempi. The orchestra no doubt deriving inspiration from its native repertoire plays very well and, as usual, Wolff has been favored with a hugely proportioned "big-hall" sound, whose rich resonance is complemented by sparkling detail. A delightful recording.

### BEETHOVEN PIANO CONCERTO NO. 4 IN G MAJOR

Claudio Arrau, pianist, with Philharmonia Orchestra conducted by Alcea Galliera. Angel 35300. RIAA curve. Price \$4.98.

Angel keeps on adding illustrious names to its roster of artists. Here is newly-signed Arrau's first effort, a splendid reading of Beethoven's "4th Piano Concerto." Also be it noted that Angel has contracted the famous Jose Iturbi, and some of his particular keyboard magic will no doubt reach us soon. Arrau's tenure with Columbia was not very happy, although several notable recordings were made. To me, he has always seemed a sort of "orphan pianist," not well understood and talent largely misused by the companies recording him. It would seem that Claudio has found a happier niche with Angel, at least on the basis of this first effort. This is a beautiful recording, equalled by few and superior to most of the 14 other recordings in the catalogue. His is a warm, highly expressive reading, not without its tougher fiber, but lacking the huge power of the Backhaus or Schnabel versions. His mood is reflective rather than dominant, but this detracts little from his smooth, unmannered exposition of the score. Of the sound afforded Arrau, there is no doubt that this is the most pervasively realistic among all the other recordings. The

Newest



# New SUPREME 1956 TV Manual

## AMAZING BARGAIN

The new 1956 TV manual is the scoop of the year. Covers all important sets of every make in one giant volume. Your price for this mammoth manual is only \$3. This super-value defies all competition. Other annual volumes at only \$3

each. Includes all data needed for quicker TV servicing. Factory service material simplifies repairs. Practically tells you how to find each fault and make the repair. More pages, more diagrams, more information per dollar of cost. Get the best for less. Get SUPREME.



## TELEVISION SERVICING COURSE

Let this new course help you in TV servicing. Amazing bargain, complete, only \$3, full price for all lessons. Giant in size, mammoth in scope. Topics just like a \$200.00 correspondence course. Lessons on picture faults, circuits, adjustments, short-cuts, I.F.F., alignment facts, hints, antenna problems, trouble-shooting, test equipment, picture analysis. Special, only **\$3**

## Companion RADIO COURSE, Introduction to TV

Here is your complete radio training in 21 easy-to-follow lessons. Covers fundamentals, fault finding, use of test equipment. Everything in radio. Introduction to TV. Self-test questions. New edition. Special, only **\$2.50**

Just out

## RADIO DIAGRAMS

Here is your complete source of all needed RADIO diagrams and service data. Covers everything from the most recent 1956 radios to pre-war old-timers; home radios, auto sets, combinations, changers, F31, and portables. Sensational values. Only \$2 for most volumes. Every manual has extra large schematics, all needed alignment facts, parts lists, voltage values, trimmers, dial stringing, and helpful hints. Volumes are large 1 1/2 size, 8 1/2 x 11 inches, about 190 pages. See coupon at right for a complete list of these radio manuals. →



## COVERS ALL POPULAR SETS

Here is your service data for faster, easier TV repairs. Lowest priced. Best by comparison. *Supreme TV* manuals have all needed service material on every popular TV set. Helpful, practical, factory-prepared data that will really make TV servicing and adjustment easy for you. Benefit and save with these amazing values in service manuals. Only \$3 per mammoth volume. The choice of wise servicemen.



## SIMPLIFIES TV REPAIRS

These giant TV manuals have complete circuits, alignment facts, response curves, service hints, production changes, voltage charts, waveforms, and many double-page schematics. Here are your authentic service instructions to help you do expert work quicker; and priced at only \$3 per large yearly manual. Repair any TV model ever made by having in your shop all 10 volumes as listed in coupon. Your special price for all, only \$30. Or try the new 1956 TV manual to see what an amazing bargain you get for \$3. Send no-risk trial coupon today.

The repair of any television set is really simple with *Supreme TV* service manuals. Every set is covered in a practical manner that will simplify troubleshooting and repair. This is the help you need to find toughest faults in a jiffy. Each \$3 TV volume covers a whole year of service material. New Television Servicing Course will aid you in learning TV. Be wise, buy *Supreme Manuals* only once each year instead of spending dollars every week for data not needed.

## NO-RISK TRIAL ORDER COUPON

SUPREME PUBLICATIONS, 1760 Balsam, Highland Park, ILL.

### Radio Servicing Manuals

Most-Often-Needed Series

1956 Radio Manual, \$2.50

1955 Radio Manual, only \$2

1954

1953

1952

1951

1950

1949

1948

1947

1946

1942

1941

1940

1939

1926-1938 Manual, \$2.50

Radio and TV Master Index, 25¢

Rush today TV manuals checked  below and Radio manuals at left. Satisfaction guaranteed.

New 1956 Television Servicing Manual, only \$3.

Early 1955 TV, \$3.  Additional 1955 TV, \$3.

1954 TV Manual, \$3.  1953 TV Manual, \$3.

1952 Television Manual, \$3.  1951 TV, \$3.

1950 Television Manual, \$3.  1949 TV, \$3.

1948 TV, \$3.  UHF Converters & Tuners, \$1.50

New Television Servicing Course, complete . . . \$3.

Companion Radio Course (all 21 lessons) . \$2.50

I am enclosing \$ . . . . . Send postpaid.

Send C.O.D. I am enclosing \$ . . . . . deposit.

Name: . . . . .

Address: . . . . .

**Supreme Publications**  
Sold by All Leading Parts Jobbers

July, 1956

109

# For Making Modern, High Fidelity Recordings

the new



## the new PROFESSIONAL DISC RECORDER

featuring:

- ★ **NEW** Overhead Recording Lathe with provision for run-in and run-off grooves.
- ★ **NEW** Vertical Cutting Head (50 to 10,000 cycles).
- ★ **NEW** Rek-O-Kut Playback Arm Model 160 for records up to 16".

Complete (less microphone) **\$599<sup>95</sup>**

slightly higher West of Rockies

Records Live, 'off-the-air', from tape or other disc recording.



Write for features and specifications to Dept. G12

**REK-O-KUT Company**  
38-01 Queens Blvd., L.I.C., 1, N.Y.

EXPORT: Mornan Exporting Corp., 458 Broadway, New York 13, N.Y.  
IN CANADA: Atlas Radio Corp., 50 W. Yonge Avenue, Toronto 10, Ontario

piano is big-toned, but very smooth and liquid in its projection, there is no transient overload or ringing, no hammer-action sound to spoil the illusion of presence. Galliera contributes a well-balanced, nicely-paced orchestral accompaniment in fine rapport with the soloist. An auspicious debut by Arrau on the *Angel* label.

### DEBUSSY LA MER NOCTURNES

**Boston Symphony Orchestra conducted by Pierre Monteux. Victor LM1939. RIAA curve. Price \$3.98.**

"Papa" Monteux has been guest conducting with his old orchestra, the Boston Symphony, and now and then *Victor* issues the fruits of some of these sessions. This "La Mer" has much to recommend, being a better performance than most in the catalogue, but like any recording of this work it must inevitably stand comparison with Toscanini's glorious reading. No, it doesn't equal that impassioned *tour-de-force* by the Maestro, but it has virtues of its own, virtues which are really a reflection of Monteux's feeling for the score. He brings to the work order without fussiness, tempi which are brisk but not headlong, and warmth but not passion. The result is easy listening, a confidence in Monteux's orchestral mastery, even though his white-capped sea is subsidiary to the tempest of Toscanini's. Soundwise this is one of the best in the catalogue with fabulous string sound from the Boston players, as well as bright brass and sharp percussion. "Nocturnes" receives a well-rounded performance, excelled only by Stokowski's version. Here too is first class sound with particularly good quality from the chorus in the "Sirens" section.

### GRIEG PEER GYNT SUITES NOS. 1 AND 2 IPPOLITOFF-IVANOFF CAUCASIAN SKETCHES

**Hollywood Bowl Symphony Orchestra conducted by Felix Slatkin. Capitol P8329. RIAA curve. Price \$3.98.**

Slatkin is a more than ordinarily perceptive conductor who has done some notably good work for *Capitol*. Even here, saddled with these warhorses, he does an excellent job. He is more successful in his reading of the "Peer Gynt Suites" than Ormandy who is his only close competitor, although his orchestra is no match for the Philadelphia. The popular "Caucasian Sketches" are given a good performance and the sound quality of both this and the "Peer Gynt" is some of *Capitol's* best. Recommended.

### BEETHOVEN SYMPHONY NO. 5 SCHUBERT UNFINISHED SYMPHONY NO. 8

**Boston Symphony Orchestra conducted by Charles Munch. Victor LM1923. RIAA curve. Price \$3.98.**

Ordinarily, with 15 or 20 recordings of a given work in the catalogue, any further duplication is a case for howls of dismay. And while in most respects a new Beethoven "5th" is hardly cause for rejoicing, there is the saving grace with this work (if with no other) that this new recording might be it . . . at last the Beethoven "5th." Alas, this effort by Charles Munch achieves the same thing as a number of others . . . a very close miss . . . but no hit. The definitive Beethoven "5th" is not yet, and for that matter may never be. Taken for itself, however, this is one of the best available. Munch has chosen brisk tempi, generally well suited to his demands from the orchestra, and if he had not dragged the *andante* in the second movement, we might have had something. He elicits

some wonderfully expressive sound from his great orchestra and the tumultuous finale is perhaps better done than in any recording so far available. The real value of this recording aside from the generally excellent performance is the sound. Once in a while, at a recording session with no change of technique involved, everything just "clicks." Whether it's the hall with that particular repertoire, the temperature in the hall, the spirit of the musicians, whatever it is . . . it happened in this recording. This is Boston Symphony sound which in its warmth, its inner detail, its cleanness of string and brass and woodwind, and its spacious acoustics I have not heard before. It is quite a wonderful effect and makes this record a desirable buy if for no other reason. The Schubert "Unfinished" gets a good but not spectacular performance, but it too in lesser measure shares the bounty of good sound. Try this and see if you concur.

### BARTOK SECOND SUITE FOR ORCHESTRA Minneapolis Symphony Orchestra conducted by Antal Dorati. Mercury MC 50098. RIAA curve. Price \$3.98.

With so much duplication of repertoire going on, it is always a welcome task to review a record premiere, especially when it is a work by an acknowledged master like Bela Bartok. This first LP of his "Second Suite for Orchestra" is going to be hard to beat if there are subsequent editions. For one thing, Dorati who was a friend and pupil of Bartok brings his authority to the reading. For another thing, this has sound that defers to none in matters of wideness of frequency and dynamics and lack of distortion. This colorful score is a product of the young Bartok, completed in 1907 when he was 26. As such, while it does not have as much of the wild atonalities and dissonances of his later works, these elements make brief appearances throughout the score. The work is essentially rhythmical and lyrical and is consequently easier to assimilate than the later scores. As with most Bartok it is full of contrast and, needless to say, lends itself very well as a vehicle for modern hi-fi recording. While not as spectacular in the direct sense as other *Mercury* recordings, it is equally amazing in a different way . . . there are thin gossamer sound textures here which are as difficult to record as the most florid percussion and brass passages. The fine delineation of horn and tympani over bassoon and other woodwinds in the finale and string and woodwind textures in other places is a recording challenge that has been met most successfully. I have no knowledge of the score but Dorati never seems to be in any difficulties and he receives splendid support from his orchestra. This might be a good score for an introduction to Bartok's music, and if there are still some readers who have not made the acquaintance of Bartok, this is less likely to bite you than most of his other works.

### FLOTOW MARTHA (COMPLETE OPERA) Feruccio Tagliavini, tenor; Carlo Taglibue, baritone; Pia Tassinari, contralto; and Elena Rizzieri, soprano with symphony orchestra and chorus of Radio Televisione Italiana (Turin) conducted by Francesco Molinari-Pradelli. Cetra B1254. RIAA curve. Price \$9.96. Two discs.

The second recording of "Martha" in the LP catalogue, this will be welcomed by many for a variety of reasons. It has a far better cast than the *Urania* recording, the sound is infinitely better, it is now two records instead of three and thus cheaper. Infrequently performed in this country, "Martha" still enjoys quite a vogue in Europe. More often than

RADIO & TELEVISION NEWS

not "Martha" has come to mean in this country, the famous tenor aria "M'appari," and in the late thirties this was even made into a popular song. For those interested in opera, there is much more to this sparkling score than that one aria, and a listen to this excellent performance will be worth your while. Tagliavini is well cast as Lionel, for the demands of the role are not taxing to his voice except for *the aria*, which he assays with but little straining. Pia Tassinari is her usual reliable self as Nancy, Tagliabue is in good voice as Plunkett. The other singers are completely unknown to me, but do well enough. Rizziere as Lady Harriet ("Martha") has a pretty young voice, with some unsteadiness in her higher register her main shortcoming. Pradelli deserves a lot of credit for holding the production together so well and for his excellent work with chorus and orchestra. Nice sound here, with voices well projected and good balance between vocal and orchestral elements. A desirable recording of an unjustly neglected work.

**VERDI**

**AIDA (COMPLETE OPERA)**

Maria Callas, soprano; Fedora Barbieri,

mezzo-soprano; Richard Tucker, tenor; Tito Gobbi, baritone; Giuseppe Modesti, bass and soloists with the orchestra and chorus of La Scala (Milan) conducted by Tullio Serafin. Angel 3525C. RIAA curve. Price \$15.94. Three discs.

This is a fabulous new production of "Aida" from *Angel*. You might say that this is the final entry in the sweepstakes for recording of choice, the *London* and *Victor* entries having appeared earlier. For those opera lovers who have put off making their purchases until all entries were in, I feel sorry. Not that they have waited unnecessarily, but that the final choice is still more complicated now. In the last analysis, I think you will probably have to ignore the critics and make your own decision based on your preferences for some artists *versus* your prejudices against others.

To illustrate what I mean take the role of "Aida." In this new *Angel* we have the fabulous Maria Callas. Her voice is not generally acknowledged as being too pretty, but none of the other "Aidas" can hold a candle to her acting. Her dramatic intensity, which she manages to project in her voice, is something that few opera singers have and she is

unlikely to be surpassed in this respect. In the *London* set we have Tebaldi as "Aida" with her supremely beautiful voice. Few will deny that in terms of sheer vocal beauty she has any peer . . . yet her acting while fair enough, is far from the Callas brand. And what about Milanov, the *Victor* "Aida", whose power is equalled by neither of the others and who has quality in her voice and is also a fair actress? You see what I mean?

The same thing could be applied to the role of Radames. Among tenors Tucker, del Monaco, and Bjoerling, which one is the best singer, actor, or combination of both? Truly among the three prime versions there would seem to be an embarrassment of riches. Of course there is also the matter of the subsidiary roles and the chorus and what kind of performance is offered by the various conductors. Too bad everyone can't have his ideal cast in one album, but that's the way it is and choose you must.

Here is my own choice and my reasoning . . . hate me for it if you will. All factors considered, among the three, this new *Angel* gets my vote. Prime factor I admit was Callas. Her portrayal was to me the most human, the most believable, even if her voice

**REMEMBER, MR. CUSTOMER!**

Over 30,000 satisfied TV servicemen can't be wrong. You can buy with confidence from VIDEO, a reputable firm with over 10 years experience. We are the sole distributor of Video Brand tubes.

**We Have OVER 1000 USED TV SETS**

At All Times In Our Huge Warehouse

Buy one or more of these WORKING TVs to sell or use as your own second set! All Sets in GOOD WORKING condition!



Your Choice—Console or Table Model

10".....\$23.00	17".....\$46.00
12".....\$28.00	19".....\$58.00
14".....\$33.00	20".....\$64.00
16".....\$40.00	21".....\$72.00
24".....\$99.00	

When ordering TVs, state whether table model or console is desired. Also preference on make of set. All TVs sent railway express F.O.B. Newark. On any quantity WIRE or CALL today!



**FREE BONUS**

ANTENNA GIVEN WITH ANY TV SET ORDER!!

**Also On Hand . . . ANY MAKE OR MODEL BRAND NEW TV OR APPLIANCE**

Prices on request! We will beat any quoted price!

SEND for our FREE complete TUBE & PARTS LIST and order blank.

**SAME DAY SHIPMENT OF ALL ORDERS!**

**DON'T PAY MORE FOR SET TESTED LONG LIFE DEPENDABLE RADIO & TV TUBES. BUY VIDEO AND PAY ONLY . . .**

**40¢**  **FOR ANY TUBE**  
we will not be undersold

Individually boxed, all guaranteed for one year or your money back

**\$37.00**  
Per Hundred

Some Standard Brand—Others With Famous VIDEO Brand

0A2	1U4	5A4W	6A5S	6BQ7	6SF7	7A7	12B4	25AV5GT
0A3	1U5	5A24	6A57G	6B57G	6SG7	7B5	12BA6	25BQ6GT
0A4	1V2	5I6	6A76	6B27	6SH7	7B7	12BE6	25CD6G
0B2	1X2	5T4	6AU4GT	6C4	6SJ7GT	7C5	12BH7	25CU6
0C3	2A7	5T8	6AU5GT	6CB6	6SK7GT	7C6	12BY7	25L6GT
0Z4	2D21	5U4G	6AUG	6CD6G	6SL7GT	7C7	12CU6	25Z6GT
1A7GT	2X2	5U8	6AV5GT	6CF6	6SN7GT	7F7	12SA7	25W4GT
1B3GT	3A4	5V4G	6AV6	6CS6	6SQ7	7F8	12SG7	35L6GT
1C7G	3A5	5V6GT	6AX4GT	6CU6GT	6SS7	7N7	12SH7	35W4
1F4	3AL5	5Y3	6AX5GT	6E5	6SV7	7Q7	12S7GT	35Y4
1H4	3AU6	5Y4G	6BA6	6H6GT	6T8	7Y4	12SK7	35Z3
1H5GT	3BC5	6AB4	6BC5	6J4	6U4GT	7Z4	12SN7GT	35Z5GT
1J6GT	3CB6	6AC7	6BC7	6J5GT	6U7G	12A6	12SQ7	50A5
1L4	3Q4	6AG5	6BE6	6J6	6U8	12AH7GT	12SQT	50B5
1L6	3Q5GT	6AF4	6BF5	6K6GT	6V3	12AT6	12V6GT	50C5
1LA6	3S4	6AH4GT	6BG6G	6L6	6V6GT	12AT7	12X4	50D5
1LC5	3V4	6AK5	6BH6	6N7GT	6W4GT	12AU6	14A7	50E5
1LH4	4B27	6AL5	6BJ6	6S4	6W6GT	12AU7	14B6	50L6GT
1LN5	4B97	6AM8	6BK5	6S7G	6X4	12AV6	14Q7	80
1N5GT	5AM8	6AN4	6BK7	6SA7	6X5GT	12AV7	19BG6G	117N7GT
1S4	5AN8	6AN8	6BL7GT	6SB7Y	6X8	12AX4GT	19T8	117P7GT
1S5	5AQ5	6AQ5	6BN6	6SC7	6Y6G	12AX7	24A	117Z3
1T4	5AT8	6AQ7GT	6BQ6GT	6SF5	7A5	12AZ7		

FREE RCA "CHEATER" CORD Given with Any Tube Order of \$7.00 or More!!

FREE POSTAGE in U.S.A. and Territories on orders over \$5.00. 25¢ handling charge on orders under \$5.00. 25% deposit required on C.O.D.'s. Please send approximate postage or freight on Canadian and foreign orders. Subject to prior sale.

**VIDEO ELECTRIC COMPANY**  
79 CLINTON PL. NEWARK, N. J.  
Phone HUmboldt 4-9848



## NOT EVERYONE APPRECIATES THE HARTLEY

It is a proven, scientific fact that musical sounds *DISCRIMINATE*. They give more listening pleasure to one person than any other, due to the ability of some blessed ears to hear true pitch. Those of you who belong to this fortunate group will truly understand and appreciate the greatness that is the Hartley 215 Speaker system.

### THE SPEAKER THAT PRODUCES NO SOUND

Whether it be a fanfare of trumpets or the roll of a drum, the sound of the instruments — nothing else — comes through the Hartley Speaker system. It is free from resonance — free from distortion. Laboratory tests confirm this statement.

### REALISTIC HIGH FIDELITY

Substitute a Hartley 215 in any system and immediately you will hear the amazing difference. Designed by H. A. Hartley, famous audio consultant, it will provide you with the best sound reproduction possible, outperforming speakers of larger size.



### Hartley 215 Speaker Systems

The renowned Hartley Baffle with one, two, three or four drivers. Prices start at \$115.75 for the complete system. At franchised dealers or write for details:



## HARTLEY PRODUCTS CO.

DEPT. 10 • 521 East 162nd Street  
New York 51, N. Y.  
LUdlow 5-4239

Now available at:

Center Camera and  
Hi-Fi Exchange  
1367 Ave. of the Americas  
New York 19, N. Y.

Bell Laboratories  
2119 1/2 West Colorado Ave.  
Colorado Springs  
Colorado

could not match the luminous beauty of Tebaldi. For Radames I would have preferred del Monaco, but if I want Callas I must take Tucker in this role. And though he strains and bellows occasionally, there is less disparity among the tenors and Tucker's job is good enough. As far as Amonasro is concerned, I would have chosen Leonard Warren, but Gobbi has the job in this *Angel* set and runs a close second to Warren in vocalizing and about equal in acting ability. For the other roles the choices in the *Angel* were not always what I would have preferred, but the average was good enough.

Two big final factors decided me . . . by far the best conducting was that of Serafin. Erede on *London* is a good opera man, better on some works than Serafin, but neither he nor Perlea in the *Victor* set managed such a well-integrated, nicely-paced reading. The other factor was the superb sound of the *Angel* discs. The *Victor* is passably good but not outstanding, the *London* a very fine recording some years back, is showing its age. Solo work in the *Angel* set, both male and female was exceptionally well miked, the voices coming through with perfect definition. The choral and orchestral work is of very high order, with no "blast" or fusion that was noticeable. Very good string, brass and woodwind sound and the whole wrapped in live sounding spacious acoustics. Throughout the work frequency and dynamic range was very wide, and there was no audible pre- or post-echo from the grooves. Summing up . . . not a "perfect" recording by any means but for me the most convincing "Aida" now in the LP catalogue.

### VERDI

#### LA FORZA DEL DESTINO (COMPLETE OPERA)

Renata Tebaldi, Mario del Monaco, Ettore Bastianini, Cesare Siepi, Fernando Corena, Giulietta Simionato, and others with chorus and orchestra of L'Accademia di Santa Cecilia (Rome) conducted by Francesco Molinari-Pradelli. London XLLA37. RIAA curve. Price \$19.92. Four discs.

Any dyed-in-the-wool opera lover will take note of the cast in this recording and promptly shout Hallelujah! Without doubt, this is one of the most magnificent casts ever assembled for the Verdi masterpiece. If the Metropolitan were able to present as imposing a production, the *aficionados* would beat down the doors! In many ways any comparison of this recording with the *Angel* recording, its only worthwhile competitor, is similar to the situation with "Aida." But the issues here are more clear cut. True, the principals in each cast are virtually identical in "Aida" and "La Forza", but what is a good and a comfortable role for a given artist in one opera, is not necessarily so in the other opera. I'll grant that the perfect cast for any opera (that is, perfect for everybody's individual taste) has never been assembled. There are one or two roles in this recording I would prefer to see handled by others, but by and large, this is to me the most generally satisfactory group of singers I have ever heard in this particular opera, either live or recorded.

Space does not permit much analysis, but I can say that the vocalizing and general characterization of del Monaco as Don Alvaro is outstanding, definitely one of the best things he has done. Tebaldi is a golden-voiced and utterly convincing Leonore, Bastianini as Don Carlo exhibits a richly resonant voice, beautifully controlled and he sounds better here than in any other role I can remember. Siepi as Padre Guardiano is in particularly fine voice, its deep richness wonderfully projected. And one's regard for Simionato grows the more she is heard. As Preziosilla she is superb, for her voice is really lovely, and acting

really good. Many of the subsidiary roles are handled by singers of considerable artistic stature and, on the whole, the results are highly gratifying.

Old Maestro Pradelli is in charge of proceedings and, as usual, he elicits some wonderful playing from his orchestra, maintains a good balance between orchestra and chorus, and generally keeps things running along smoothly. Except for a little too fast a pace in the final act, his tempi are all quite reasonable. Most outstanding in this album is the sound, which is one of the most satisfactory recordings ever made by *London*. The balance is nigh perfect, the acoustics are spacious but not overdone, frequency range and dynamics are as wide as most symphonic material. The voices have a pure clear definition that makes for easy intelligibility, and the orchestra is good sounding too, with bright string tone, crisp brass and percussion. Pre- and post-echo, the curse of many an opera recording is almost totally absent here. All in all, this is one of *London's* most stellar achievements in recorded opera. Highly recommended.

### ROSSINI

#### FIVE OVERTURES

London Symphony Orchestra conducted by Pierino Gamba. London LL1366. RIAA curve. Price \$3.98.

Not too long ago Gamba was a child prodigy in a strange field . . . conducting. Dismissed by many as mere sensationalism, the young Mr. Gamba has evidently weathered the storm and if we can judge by his picture on the album cover, he is considerably matured. He conducts the "Siege of Corinth," "Il Signor Bruschino," "La Cenerentola," "Tancredi" and last, but not least, "William Tell" overtures. He is no slouch either . . . he knows how to control his forces quite well and his readings are quite acceptable. Of course he doesn't equal the refinement and the fire and dash that Toscanini and others have brought to these scores, but that's hardly a fair comparison. Main advantage here is the resplendent sound, by far the best available for these works. Nice incisive strings, brilliant brass, and some notably accurate percussion combine with the fine acoustics for exceptional realism. If you have kids who like the "Lone Ranger," and you have a good hi-fi system, you can now have the dubious pleasure of playing for them the most hi-fi "William Tell" in existence!

### CHOPIN

#### LES SYLPHIDES STRAUSS, JOHANN, JR. GRADUATION BALL

Boston Pops Orchestra conducted by Arthur Fiedler. Victor LM1919. RIAA curve. Price \$3.98.

A happy combination this, as played by the inimitable Boston Pops. "Les Sylphides" has been done many times before, a notable version being that of Desormiere on *London*, and while that was a splendid recording and a good reading, we'll have to give the blue ribbon to Fiedler and his men. They are blessed with a more modern and felicitous sound, better acoustics for one thing and cleaner string tone for another. Main point of superiority however is the Boston players who are quite a few rungs above the men of the Paris Conservatory Orchestra. With "Graduation Ball," Fiedler has stiffer competition from Fistoulari on *London*, in both matters of sound and performance. The *London* was a very good recording and this just squeaks by as somewhat better in detail and wider in dynamics. Performance-wise Fiedler hurries things more than Fistoulari and the thing that saves him and makes it an exciting reading is the ability of his Boston men to play fast while keeping everything in nice crisp

RADIO & TELEVISION NEWS



definition. Another good disc for easy summer listening.

### Tape Review

#### DVORAK

#### SYMPHONY NO. 5

Philharmonic Symphony Orchestra of London conducted by Artur Rodzinski. Sonotape SW3002. 7" reel, half-track, 7 1/2 ips. NARTB curve. Price \$8.95.

This is a particularly fine symphonic recording on a Sonotape and on comparison with the Westminster original, it is easy to discern how much better is the tape and why it is worth the difference in price. The string tone which was quite good on the disc seems almost "shrieky" when you hear the bright but smooth tape sound, the trumpets and trombones, clear in their enunciation on the disc, really speak out in huge forceful brazen tone on the tape. Woodwinds have a purity of tone and an almost palpable liveness and the percussion which has always been a Westminster specialty and was excellent on the disc, is really spectacular here, with a bass drum of noble proportions and cleanness, and tympani which sound out with great weight and sharply accented precision. The London Symphony under its *nom-de-plume*, does a superb job under the expert urgings of Rodzinski. The Dvorak work has long been one of his specialties and he acquits himself well here in a fast-paced rather taut reading that generates plenty of excitement. Really a per-

formance good enough to stand beside such notable efforts by Kubelik and Toscanini. A fine performance and a magnificent sound add up to one of the most satisfactory recorded tapes now available.

### Hi-Fi—Audio Equipment

(Continued from page 84)

±2 db at 40 to 15,000 cps. Input is provided for two high impedance microphones with 120 db gain.

A three-speed turntable will handle records up to 17 1/4" in size. The player is equipped with a G-E variable reluctance twist-type pickup with individual easily replaceable jewelled needles for standard or microgroove records.

#### LOW-COST AMPLIFIER

A low-cost amplifier which provides output constant within 1 db from 15 to 30,000 cps has been added to the Fisher Radio Corporation line of power amplifiers.

The Model 20-A has less than .7% distortion at 15 watts and a virtually inaudible hum and noise level, 90 db below the full rated output. The amplifier is designed to be used with a per-

preamp-equalizer. In addition it is designed to operate with components that lack their own power supply. An octal socket provides all necessary a.c. and d.c. operating voltages, plus con-

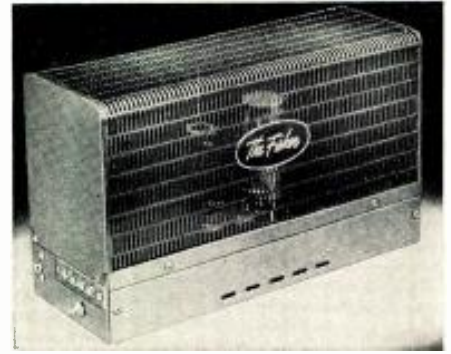

nections for switching the amplifier on and off from a remote position. Output impedances are 4, 8, and 16 ohms.

Write the company at 21-21 44th Drive, Long Island City 1, New York for complete specifications.

#### MATCHED ENCLOSURES

G & H Wood Products Company, Inc., 99 North 11th Street, Brooklyn, New York has added matched speaker

## PRACTICE CODE TAPE SETS

**INKED PAPER TAPES**—For code practice and training—for radio operators, Hams, amateurs, beginners, and telegraphers. 15 lessons to a set on 16 mm 400 ft. reels that can be reproduced on TG-34A and TG-10 Keyers. SET OF 15 REELS IN WOOD CASE... **\$18.95**

**TG-34A KEYSER:** Automatic unit for reproducing audible code practice signals previously recorded in ink on paper tapes—with speaker and phone jack for plugging in headset. Variable speed motor control to 25 WPM, keying oscillator for use with hand key—Complete portable unit with Tubes and Manual... **NEW: \$16.95**

## CLASSIFIED ITEMS:

BC-212G Amplifier—2/6C5 tubes.....NEW: \$ 1.95  
BC-216 Amplifier—6F7 & 39/44.....USED: 1.50  
BC-229/429 Receiver—2500-7700 KC w/Coils. U: 6.95  
BC-230 Transmitter—2500-7700 KC w/Coils. U: 8.95  
BC-347 Amplifier—1/6F8G tube.....N: \$3.95; U: 1.95  
BC-357 Beacon Rec.—75 MC.....N: \$4.95; U: 2.95  
BC-367 Amplifier—2/6V6 tubes.....N: \$4.95; U: 2.95  
BC-375 Transmitter.....Used: 29.95  
Tuning Units f/BC-375: TU-5-6-7-8-9-10-26. U: Ea. 3.95

Cables f/BC-375/BC-191. PL-61, 64 or 59. each end: Ea. 2.75

BC-442 Antenna Relay Box—w/Cond. 64 end: Ea. 2.95  
BC-463 Trans. 67-74 MC. 20 Watt. 16 Tubes. U: 16.95  
BC-603 Receiver FM—20-28 MC. Used: 29.95  
BC-604 Trans. FM—30 Watt. 20-28 MC. Used: 18.95  
BC-500 Trans. & Rec.: 25 Watt. 20-28 MC. New: 59.50  
BC-617 Receiver Only. 30-40 MC w/Dyn. Used: 24.95  
BC-654 Transceiver: 3800 to 5800 KC. Used: 34.95  
BC-709 Amplifier—Battery Operated.....New: 1.95  
BC-745 Transceiver: 3 to 6 MC.....Used: 14.95  
BC-924 Trans. FM—30 Watt. 27-38.9 MC. New: 24.95  
BC-966 IF—160-211 MC. 13 tubes.....Used: 5.95  
BC-1158 Trans.: 50 Watt. 53.3-95 MC.....New: 39.95  
RM-12 Radio-Telephone. Remote Control. Used: 19.95  
RM-13 Telephone. Remote Control. N: \$24.95; U: 19.95  
RM-21 Remote Control Box for BC-669.....4.95  
SCR-625 Mine Detector—Reconditioned.....39.95

SCR-522 Transceiver: 100-156 MC.....Used: \$34.95  
Rec. Chassis only.....w/Tubes: 19.95  
Trans. Chassis only.....Less Tubes: 9.95  
Schematic & Conversion Information only.....2.50

ID-60/APA-10 Panoramic Oscilloscope.....New: 49.50  
TBY Transceiver: 20-80 MC. 4 Bands. w/Tubes. U: 19.95  
R1/ARR-1 Receiver—Converts to 2 or 6 Meters.. 2.95  
RT-7/APN-1 Alltimer—440 MC.....Used: 9.95  
RT-34/APN-13 Transcvr. Comp. less tubes. U: 3.95  
R-74/DRW-2 Receiver—53.88 MC—6 Tubes. N: 9.95  
TG-34A Keyer: 115/230 V. 50-60 cy. w/Tubes. N: 16.95  
TG-10 Keyer: Complete w/Tubes.....Tested U: 14.95  
T-121 Transmitter—3-4 MC with Codar.....7.95  
Range Beam Filter, Navy Type \$1.95; FL-8 Used: 1.49  
EE-8 Field Telephones—Checked.....Used: 14.95  
BD-72 Portable 12 Line Switchboard.....Used: 39.95  
Sound Powered Head & Chest Set—Checked.....3.95  
Sound Powered Head & Handset f/Mark II. Used: 2.95

TS-9 Handset w/Switch—No Plugs. N: \$5.95—U: \$ 3.95  
TS-13 Handset w/Switch. PL-68 & PL-55. Used: 5.95  
TS-15 Handset w/Switch. PL-68 & PL-55. New: 7.95  
T-17 Microphone—Used. Checked.....3.95  
HS-30 Headset—Hearing Aid Type—L.N.....1.50  
CD-874 Cord—f/HS-30—Low Imp. w/PL-55. U: .59  
CD-515 Cable for BC-669.....2.75  
CD-605 Cord—f/HS-30—High Imp. w/PL-54. N: .79  
CD-307 Cord—w/PL-55 & JK-26.....U: .59  
CD-318 Cord—2/PL-68. JK-48, & SW-141. U: .89  
GN-45 Handcrank Generator w/Legs & Seat.....9.95  
R-4/ARR-2 Receiver—234—258 MC. w/Tubes. U: 4.95

BC-1206 Receiver: 200 to 400 KC.....New: \$9.95  
BC-1206 Receiver/Less Tubes (200-400 KC). U: 3.95  
12 Volt Dynamo for BC-1206.....4.95

#### ANTENNA EQUIPMENT:

MP-22 Mast Base—Swivel type.....\$2.95  
MP-5-33 Mast Base—Spring type.....5.95  
MP-48 Mast Base—Spring type.....4.95  
MP-37 Mast Base—Spring type.....6.95  
Mast Sections for above bases—MS-49 to 53.....ea. .50

#### BLOWERS—115 VOLT 60 CYCLE:

100 CFM—Single outlet, size: 5" x 6".....\$ 8.95  
100 CFM—Dual outlet, size: 8" x 6".....13.95  
200 CFM—4" intake. Size: 8" x 7" x 6".....14.95  
100 CFM—Flange and Flap Director.....6.95

#### COMMAND EQUIPMENT:

(NAVY—274) USED: NEW:  
190—550 KC Receiver.....\$14.95 \$14.95  
520—1500 KC Receiver.....14.95 19.95  
1.5—3.0 MC Receiver.....9.95  
6—9 MC Receiver.....4.95  
100—156 MC Receiver (R-28).....10.95  
2.1—3 MC Transmitter.....5.95 7.95  
3—1 MC Transmitter.....6.95  
4—5.3 MC Transmitter.....4.95  
7—9 MC Transmitter.....4.05 7.95  
100—156 MC Transmitter.....14.95  
BC-456 Modulator.....2.95

#### WRITE US YOUR REQUIREMENTS:

Whatever your needs in Generators, Blowers, Inverters, Motors, etc.—write us. Chances are we have it!

## DYNAMOTORS & GENERATORS:

INPUT VOLTS:	OUTPUT VOLTS:	STOCK No.	PRICES USED:	NEW:
12 VDC	220	DM-34	\$2.95	\$ 4.95
12	625	DM-35	9.95	12.95
12	230	PE-133	4.95	6.95
12 or 24	540	DA-12		14.95
12 or 24	230	DA-14		8.95
14	220	DM-24	4.95	7.95
14	1030			
14	515	DM-42	4.95	9.95
14	375	BD-83	3.95	4.95
14 VDC	330	BD-87	3.95	5.95
14	250	DM-25	6.95	8.95
14	1000	BD-77	14.95	24.95
24	250	PE-86		8.95
28	1000	PE-73		8.95
12 to 24 VDC PM Dynamo—Supplies 24 VDC 2 A. from 12 VDC. also 500 V 50 MA. @ 6 VDC will supply 12 VDC & 250 V 50 MA.				
#0515.....New: \$4.95				

#### METERS:

**WESTON AC AMMETER:** (Pictured) In portable leather case, with Test Leads, 2 1/2", 0-15 AC and 0-3 AC Scale..... **\$5.95**



**DC AMMETER HOYT:** In portable metal case, with Test Leads, 4 1/2", Fan Mirrored Scale 0-15 ADC.....\$4.95  
**DB METER—10 to Plus .6 Westinghouse 3".**  
NC-35 Imp. 600 ohms @ 1000 cycle.....4.95  
0-1 MA Weston 506 2 1/2" Rd.....New: 3.95  
0-3 RF AMMETER IS-128 2 1/2" Rd.....New: 2.95  
0-8 Amp RF w/Thermocouple IS-89 2 1/2" Rd.....4.95  
0-15 AC DC 2 1/2" Rd.: IS-122.....4.95  
0-500 MA DC 2 1/2" Rd.: IS-22.....4.95  
0-150 V. 60 cycle: Simpson 3 1/2" Rd.....3.95  
0-250 MA DC—DeJur. 3" Sq.....3.95  
OUTPUT—5 Ranges, 4000 ohm Imp.—Used.....4.95

#### TRANSFORMERS—115 V. 60 CYCLE PRI.:

600 VCT/100 MA—6.3 V/5 A.; 5 V/3 A.....\$4.95  
350 VCT/40 MA—6.3 V/2.4 A.; 6.3 V/6.....1.75  
1300 VCT/350 MA—5 inches Sq.....6.95  
700 VCT/150 MA—5 V/3 A.; 6.3 V/1.5 A. CSD.....3.95  
250 V/0.015 A. 2.5 V/175 A.; 6.3 V/6 A.....5.95  
1890 V/12.6 MA—Tapped 2.5 V 2 A.....5.95  
1100 V/80 MA—7.5 VCT/3.25 A.....5.95  
720 VCT/50 MA—6.3V/2.5 A—5V/2 A.....2.50  
662 VCT/110 MA—6.3V/2 A—5V/2 A.....3.95  
800 VCT/300 MA—12.6V/10 A—5V/3 A.....6.95  
16 Volt 35 Amp. 115/230.....\$24.95; 24V—1 Amp 1.50  
9 Volt CT—35 Amp.—Tapped 4.5 V.....7.95  
12 Volt—Two separate windings—4 amp each.....5.95  
5 V/2 A.; 5 V/2 A.; 5 V/2 A.; & 5 V/6 A.....2.95  
600-0-600 VAC—200 MA. 12.5 V. 2 A.; 12.5 V. @ 2 A.; 5 V. @ 3 A.—#H-108—Price.....8.95  
250-0-250 VAC—50 MA. 24 V. 1 A.; and 6.3 V. I A.—#H-109—Price.....4.95

Choke—12.5 Hy/100 MA.....\$1.95  
Choke—8 Hy/150 MA—200 Ohm—Open Frame.....1.25  
Choke—5 Hy/150 MA—85 Ohm.....1.50  
Choke—10 Hy/250 MA—2 1/2" x 2" x 3" Potted.....4.95  
Choke—5 Hy/400 MA—4 1/2" x 4" x 5 1/2".....4.95  
18.4 Hy. 1 Amp 100 Ohm—7 1/2" x 5 1/2" x 6 1/4".....6.95

Address Dept. RN • \$5.00 Order Minimum, & 25% Deposit on C.O.D.'s • Prices are F.O.B. Lima, Ohio

**FAIR RADIO SALES** 132 SOUTH MAIN ST. LIMA, OHIO



# DON'T THROW OLD RADIOS AWAY!

Here's the data you need to fix them FAST... and good as new!

Just look up the how-to-do-it data on that old radio you want to fix!

Four times out of 5, this giant, 3 1/2-pound, 744-page Ghirardi RADIO TROUBLESHOOTER'S HANDBOOK gives exactly the information you need to fix it in a jiffy. Tells what is likely to be causing the trouble... shows how to fix it. No useless testing. No wasted time. Handbook covers practically every radio receiver model made by 202 manufacturers between 1925 and 1942. Using it, even beginners can easily fix old sets which might otherwise be thrown away because service information is lacking. With a few simple repairs, most of these old sets can be made to operate perfectly for years to come.

## THE ONLY GUIDE OF ITS KIND! Cuts service time in half!

Included are common trouble symptoms and their remedies for over 4,800 models of old home, auto radios and record changers. Airline, Apex, Arvin, Atwater Kent, Belmont, Bosch, Brunswick, Clarion, Crosley, Emerson, Fada, G-E, Kolster, Majestic, Motorola, Philco, Pilot, RCA, Silvertone, Sparton, Stromberg and dozens more. Gives how-to-do-it data on SPECIFIC jobs—NOT general theory. Includes hundreds of pages of invaluable tube and component data, service short cuts, etc.

### TRY IT 10 DAYS... at our risk!

Dept. RN-76, RINENHART & CO., Inc.  
232 Madison Ave., New York 16, N. Y.  
Send Ghirardi's RADIO TROUBLESHOOTER'S HANDBOOK for 10-day free examination. If I decide to keep book, I will then remit the full price of only \$9.50 plus a few cents postage. Otherwise, I will return book postpaid and owe you nothing.

NAME .....

ADDRESS .....

CITY, ZONE, STATE .....

OUTSIDE U.S.A.—Price \$7.00 cash with order only.  
Money back if book is returned in 10 days.

# TUNERS CONVERTERS

CRYSTAL CONTROLLED  
POLICE • FIRE • CIVIL DEFENSE



- ✓ Precision—Stability
  - ✓ Sensitivity
  - ✓ Easy installation
- only \$29.50 net

• A compact converter supplied with commercial tolerance crystals, made to your exact frequency requirements. Furnished with tubes and crystal.

A practical low cost converter suitable for 30-50 or 6 meter band. Net \$18.50.

## VARIABLE TUNERS

Improved AM-FM now available for 26 through 170MC in 3 types from \$22.50



## 12 WATT MOBILE PA AMPLIFIER

CIVIL DEFENSE, POLICE, FIRE  
An extremely compact and durable 12 watt amplifier for 6 and/or 12 volts. 2 outputs, one mike, one phone. 2 output connections. 6 volt model list \$97.50.

WRITE FOR LITERATURE

KUHN ELECTRONICS

20 GLENWOOD CINCINNATI 17, OHIO

enclosures and hi-fi equipment cabinets to its "Cabinart" line.

The Models 27 and 28 enclosures are available as "do-it-yourself" kits. The equipment cabinet will house record changer or player, tuner, and amplifier. The matching bass reflex cabinet has a baffle area of 6 square feet and

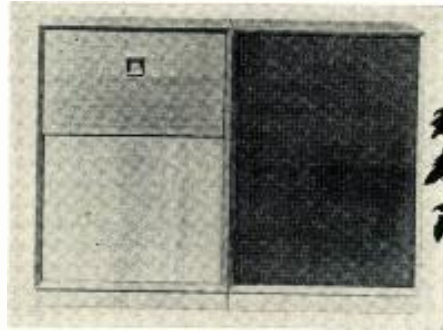

stands 35" high, 23 1/2" wide, and 17 1/2" deep. While the equipment cabinet duplicates the external dimensions of the speaker housing, the interior is divided into two compartments.

Both enclosures are of white pine plywood, 3/4" thick. The grain on this wood lends itself to a natural blonde finish or the cabinets may be painted or stained to suit the assembler.

### OFFICE TAPE RECORDER

Telectro Industries Corp., 35-16 37th Street, Long Island City 1, New York has developed a compact, lightweight tape recorder which has been especially designed for office dictation and playback.

The Model 556R has a separate microphone which permits private recording, a separate foot pedal for instantaneous start and stop, playback, backspacing, erasing and editing, re-winding, and listening. Playback can be heard through an internal speaker



or a separate headset. The volume control turns the machine on. Operation is completely automatic.

The unit will record up to 1 hour on a 5" reel of magnetic tape. Smaller reels can be used for shorter messages. The recorded tapes can be filed or mailed.

### NEW CERAMIC CARTRIDGE

The electronics division of Elgin National Watch Company has entered the high-quality ceramic cartridge market with a new line of original equipment and replacement units.

The new line will be marketed by the company's California affiliate,

American Microphone Company. A new turnaround "throwaway" cartridge highlights the new line. It uses an osmium needle for both 33 1/2 and 45 rpm play and a newly-styled sapphire needle for 78 rpm recordings of both ancient and recent vintage.

A positive "snap-in" action automatically locates the single needle replacement in proper alignment without the use of tools.

### TAPE DECK HOUSING

Fenton Company, 15 Moore Street, New York 4, New York is currently handling a new carrying case which is designed to accommodate the Brenell tape deck and preamplifier distributed by the firm.

The case comes complete with mounting hardware. It is tan, leatherette covered, modernistically styled lightweight case with white plastic perforated grilles on the front and back. The front is slanted to about 80 degrees, thus permitting the use of the preamplifier combination either hori-



zontally or vertically. This tilt makes the loading of tape a simple drop-in operation.

The three items—tape deck, pre-amp, and case—are available separately.

### MICROPHONE SWITCH

Atlas Sound Corp., 1451 39th Street, Brooklyn 18, New York has announced the availability of a new microphone switch, the Model FS-1.

Although designed primarily for foot operation, its compact size makes it suitable for hand operation on table top, switchboard, desk, etc. It is completely shielded and firmly grounded for noise-free operation.

The Model FS-1 is supplied as a "press to open" switch. The normal, closed position shorts the microphone. Depression of the switch removes the short from the circuit and the mike becomes operative.

The company will supply additional details and prices on request.

### PUSH-BUTTON CHANGER

Audiogersh Corporation, 23 Park Place, New York 7, New York has recently introduced a new model of the "Miracord" record changer which features five push-buttons for completely automatic operation.

The newest addition to the earlier model consists of a stop button which arrests the changer at any point in its operation and restores the entire mechanism to a neutral position from which the equipment can be put back

into operation by pushing the "start" button.

The tone arm never has to be touched or lifted from the record and whatever records are on the "Magic Wand" spindle can remain there and do not have to be discharged to put the unit at the rest position.

A data sheet on the five-button "Miracord XA-100" changer is available from the company on request.

## AUDIO CATALOGUES

### CABINART LINE BROCHURE

The "Cabinart" division of *G & H Wood Products Co., Inc.*, 99 North 11th St., Brooklyn, New York has released a pocket-size catalogue detailing its extensive line of cabinets for speakers and equipment.

Pictured and described in this 34-page booklet are kits and ready-assembled units in finished and unfinished form. The line is extensive enough to meet the equipment housing requirements of almost any audiophile.

A free copy of this brochure is available for the asking.

### AMERICAN MICROPHONE LINE

The Electronics Division of *Elgin National Watch Company* has just released a new 20-page catalogue covering its extensive line of American microphones and phonograph cartridges.

Styled in yellow and black to match the new packaging of the product line, the catalogue lists prices, speci-

fications, and characteristics of each item currently being marketed by the division.

Highlighting the catalogue is a section devoted to the new ceramic "turn-over" and single needle phonograph cartridges recently added to the line.

Copies of this catalogue are obtainable from the company at Elgin, Illinois. Request Catalogue No. 47. —30—

## Single-Gun Color Tube

(Continued from page 63)

mainder of the receiver outlined in heavy solid lines is shown in four separate sections: the index amplifier, the "pilot" carrier oscillator and color mixers, the writing frequency amplifier, and the horizontal sweep and high voltage.

The horizontal sweep-high-voltage section is similar to monochrome practice. Some details include the use of a pair of 6CD6 tubes for horizontal drive, and a special high-perveance diode, the L-1379, as the damper. The 30 kilovolt supply is obtained by a voltage doubler using 1B3's.

To aid in maintaining horizontal sweep linearity with changes in line voltage, and to maintain a nearly constant picture height, it appears advantageous to derive the plate supply voltage for the horizontal and vertical oscillators from the regulated energy in the horizontal system.

Vertical dynamic focus only is used

in this receiver; for this, a vertical frequency parabola is applied to a focus control tube. The high-voltage supply must have two regulated outputs in order to maintain optimum focus, horizontal sweep operation, and index. This has been accomplished by use of two all-glass gas regulators.

The mixer unit consists of two tubes whose triode sections accomplish nearly all the color signal processing required by the receiver. The functions of this section are to generate an unmodulated "pilot" frequency carrier, and to transfer the chrominance modulation to a second "pilot" frequency carrier. The latter signal is mixed with the amplified index information derived from the CRT to form a chrominance-modulated writing signal which includes the positional information of the index signal.

The chassis shown in Fig. 5 contains the complete receiver including the power supply. This receiver, as a developmental type, does not use an excess of dual-section tubes, yet its complement is only eight tubes more than a shadow-mask receiver containing the same non-display circuitry. In the foreseeable future this differential may be not more than five tubes. Against this disadvantage are the potential advantages of an electron optical system requiring only two alignment adjustments and a cathode-ray tube completely free from static and dynamic white balance, and magnetic field problems. —30—

**biggest dollars**  
**worth ever!**  
**STANLEY'S**  
**HIGH QUALITY**  
**TUBES**  
**never before**  
**price slashed so**  
**LOW!**



**STANLEY**  
**ELECTRONICS CORP**  
935 MAIN AVE., PASSAIC, N. J.  
Department MR-2

## LARGEST TUBE STOCK ANYWHERE!

0Z4	1PSGT	5Z4	6BBG	6J7	6SS7	7N7	12Z3
1A3	1Q5GT	6A3	6BA6	6J7GT	6TB	7Q7	14A5
1A5GT	1M5	6A5G	6BA7	6J8G	6UB	7XG	14A7
1A6	1S4	6A7	6BC5	6K5GT	6V6GT	7Y4	14Q7
1A7GT	1S5	6A8	6BD5GT	6K6GT	6W4GT	7Z4	19BG6G
1A8S	1T4	6A8GT	6BE	6K7	6WSGT	12AG	19B6
1A8X	1T5GT	6A84	6BF5	6K7GT	6X4	12AT6	19T6
1B3GT	1U4	6A87	6BC6G	6KR6	6X5GT	12AT7	24A
1B4P	1V	6AC5GT	6BH6	6KR8GT	6Y6G	12A06	25AV5GT
1B5	1V2	6AC7	6BJ6	6L60A	7A4-XXL	12A07	25B06GT
1B7GT	1V5	6AF4	6BK5	6L7G	7A5	12AV6	25L6GT
1C3	1X2A	6A05	6BK7A	6N7	7A6	12AV7	25V5
1C5GT	2A5	6AC7	6BL7GT	6P5GT	7A7	12AX7	25Z3
1C6	2A6	6AM4	6BN6	6Q7	7A8	12AY7	27
1C7G	2A7	6AH6	6BQ6GT	6Q7GT	7A9	12BA6	32L7GT
1C8	2B7	6AJ5	6BQ7A	6R7	7AM7	12BA7	35A5
1D5GP	3A4	6AK5	6BY5G	6S4	7A17	12B4	35R5
1E5GP	3A5	6AL5	6BZ7	6S7G	7B4	12BE6	35C5
1E8	3ABG1	6AL7GT	6C4	6S8GT	7B5	12BH7	35L6GT
1F7G	3B7	6AQ5	6C5GT	6SA7	7B6	12BY7	35W4
1H4G	3D6	6AQ6	6CF5	6SA7GT	7B7	12J5GT	35Z3
1H5GT	3D4	6AQ7GT	6C6	6SC7	7B8	12K6	35Z5GT
1HG7	3Q5GT	6A55	6CB6	6SG7	7C4	12SA7	45Z5GT
1J6GT	3G6	6A76	6CD6G	6SH7GT	7C5	12SA7GT	50A5
1L4	3V4	6AU8	6C86	6S17	7C6	12S07	50B5
1L6	5AX4	6AU5GT	6D6	6S17GT	7C7	12S7GT	50C5
1L6G	5T4	6AU6	6E5	6SK7	7E5	12S7GT	50L6GT
1LCS	5U4G	6AV5GT	6FSGT	6SK7GT	7E6	12SK7GT	70L7GT
1LCC	5V4G	6AV6	6F6GT	6SL7GT	7E7	12SK7GT	75
1LD5	5X4G	6AX4	6F7	6SN7GT	7F7	12SK7GT	77
1LE3	5Y3G	6AX5GT	6GG6	6SQ7	7F8	12SN7GT	78
1LGS	5Y3GT	6B5	6M6GT	6SQ7GT	7G7	12SQ7GT	80
1LNS	5Y4G	6BG6	6J5	6SR7	7J7		
1NSGT	5Z3	6B7	6J6	6SR7GT	7K7		

If it isn't listed here we'll write us for you

## BRAND NEW DUMONT and RCA Lic. PICTURE TUBES

No Replacement Dud Required! • All Brand New • Full One Year Guarantee  
Discounts for the Quantity Purchaser • Partial Listing  
F.O.B. Passaic, N. J. Shipped via Railway Express

10BP4	\$10.95	15DP4	\$16.95	16RP4	\$17.00	19AP4	\$23.00
12LP4	12.95	16DP4	18.50	17BP4	19.00	20CP4	24.00
14CP4	15.25	16GP4	19.25	17GP4	21.00	21ALP4A	24.00
		16KP4	17.00	17LP4	18.00	21EP4	24.00

### WRITE FOR STANLEY'S NEW FREE PARTS CATALOG.

Lowest prices anywhere on Transmitting Tubes, Antennas, Speakers, Condensers, etc.

TERMS: FREE POSTAGE on all prepaid continental U.S.A. orders on receiving tubes only. All picture tubes F.O.B. Passaic, N. J. 50¢ handling charge on all orders under \$5.00. 25% deposit on all C.O.D.'s. Subject to prior sale.

**TAKE**  
**YOUR**  
**CHOICE!**  
**ANY**  
**ASSORTMENT**  
**RECEIVING**  
**TUBES**

**47¢**  
**EACH**

Unconditionally Guaranteed for one year.

FREE POSTAGE on all prepaid continental U.S.A. orders.

# THIS IS



## 3 MINUTES IS ALL IT TAKES TO ATTACH IT TO YOUR PRESENT TV SET . . . .

### NO TOOLS WIRES SO SIMPLE



Changes Stations Automatically from Your Easy Chair or Bed Anywhere in the Room.

**MAKES AN IDEAL GIFT**

*Fits All Makes of TV Sets*

**\* GUARANTEED \***

# \$1995

COMPLETE

50% less than other TV Remotes

No TV should be without it

Available at Leading Dept. Stores and Dealers Everywhere

**AS ADVERTISED NATIONALLY**

SOME TERRITORIES AND FRANCHISES STILL OPEN FOR JOBBERS, WHOLESALERS, ETC.

ALSO FACTORY REPRESENTATIVES FOR CERTAIN AREAS NOT PRESENTLY COVERED.



**TV REMOTE CONTROL CO. INC.**

2310 S. LaCienega Blvd., Los Angeles 34, Cal.

## Repairing Oscilloscopes

(Continued from page 68)

input of the horizontal amplifier. Connect the "hot" lead from the vertical input of the scope to various points in the horizontal amplifier chain. A vertical line will be seen on the scope when the "hot" lead connects to a circuit point at which signal is present. If a vertical line indication is obtained at some circuit point, say the plate of a tube, but is not obtained at a directly succeeding circuit point (the grid of the next tube), the trouble lies between the two points.

2. Apply the test signal through a .1- $\mu$ fd. capacitor to various points in the horizontal chain, starting with the horizontal deflection plates and working backward. A horizontal line will be seen on the CRT screen if the circuit between the point to which the signal is applied and the horizontal deflection plates is operating normally. The first circuit point where such a line is not produced (when the test signal is applied to the point) is the approximate site of the trouble. Voltage, resistance, and capacitor bridging or substitution tests should locate the faulty component in short order.

Keep in mind that passage of a test signal through the horizontal oscillator does not necessarily prove that the stage is operating normally. A tube can have enough gain to pass a signal with slight amplification, and yet may be unable to oscillate. In most modern scopes, the horizontal oscillator is a vacuum-tube multivibrator type. The same troubleshooting techniques used for checking a comparable sweep oscillator in a TV set may be employed to test this circuit.

### Other Troubles

When a normal horizontal sweep can be obtained on the scope screen, but it is impossible to obtain a stable waveform by suitable manipulation of the sync control, sync trouble is present.

On internal sync, some of the signal whose waveform is to be observed on the scope is fed back to the horizontal oscillator, to sync the latter. In some instances, an amplifier is employed to increase the amplitude of the sync signal as well as to shape it properly; in others, the signal is fed back without amplification. If a sync amplifier tube is used, and trouble is present, try a new tube. If this doesn't cure the trouble, check the circuit through which the sync signal is fed from the vertical section to the horizontal oscillator. Remember, in many cases proper lead dress is important to the correct operation of the sync system (as well as the vertical amplifier).

Hum in the sync system may be the cause of unstable waveforms. If the same sync performance is obtained when the sync switch is on the "internal" as on the "line" setting, hum is probably present (normally, better

sync performance should be obtained on the "internal" setting of the switch). The hum symptoms are generally due to cathode-heater leakage in a tube; in cases where the scope has been built by the owner or improperly serviced, faulty lead dress is likely to be the cause of hum.

The servicing of the vertical section of the scope depends on the nature of the symptoms present. If the section is completely dead, *i.e.*, no vertical deflection can be obtained, check the tubes in this section. If no faulty tube is present, apply an a.c. test signal to various points in the vertical circuits. The method is similar to the one used in troubleshooting the horizontal stages, except that a sine wave rather than a horizontal line will be seen on the screen when the circuit section between the point where the test signal is applied and the vertical deflection plates is normal. After the defective stage has been located *via* this signal substitution procedure, voltage, resistance, and related checks should readily locate the faulty component.

Other common conditions (besides inoperation) that may be produced by defects in the vertical amplifier section include improper frequency response and hum. Tests for improper frequency response are called for when application of a normal test signal—say, a TV horizontal sync pulse—to the vertical input of the scope produces a waveform whose shape and/or amplitude is incorrect. Hum in the vertical section will cause the horizontal trace to be wavy even when the vertical input leads are shorted together. Hum is usually due to heater-cathode leakage in a tube, or improper lead dress (particularly in the first stage of the vertical section).

To check the frequency response of the vertical amplifier, the same techniques used in checking the video amplifier of a TV set may be applied. A response check with a square-wave generator is the best test. When a square-wave generator is not available, the composite video signal present at the detector of a good TV set can be used. The horizontal sync pulse serves as the test signal in this case. Since the repetition rate of this signal is 15,750 cps, and since approximately 20 harmonics of the fundamental frequency must be present to make a good square wave, proper reproduction of the horizontal sync pulse by the scope will test the response of the latter up to 300 kc. The service technician must be familiar with the frequency limitations of his scope when making such a test. That is, he must know what the horizontal sync pulse will normally look like on the screen of his scope, when the latter is operating correctly. Before a particular TV set is used as the source of the test sync pulse, make sure that the receiver is in good working order and its i.f. system is properly aligned. The station being received must be tuned in correctly. If these precautions are not observed, the sync pulse seen on the

scope may show signs of poor frequency response even when no defect exists in the scope.

Faults to look for in the reproduced square wave include: 1. Tilting at the top of the waveform with the trailing edge shorter than the leading edge (see Fig. 5A). This characteristic indicates poor low-frequency response (or excessive phase shift). 2. Rounding of the front corner of the waveform (Fig. 5B); such a symptom points to poor high-frequency response. 3. Overshoot and ringing, due to excessive high-frequency response (Figs. 5C and 5D). Check especially all coupling capacitors and plate load resistors whenever poor high- or low-frequency response is encountered.

Ringing may be due to a gassy tube.

Be sure to check the scope probe (if one is used) at the same time the scope is being checked, since a defect in the probe can introduce the same symptoms as a defect in the scope's vertical amplifier. (A low-capacitance probe must be adjusted for the scope it is used with; a trimmer is provided in such a probe, to correct for tilt or overshoot.)

When response checks of the individual vertical stages have located the faulty one, conventional voltage, resistance, and capacitor bridging or substitution tests will reveal the defective component.

Table 1 is a synopsis of the various tests discussed in this article. —30—

## RAYTHEON TO INSTALL CANADIAN RADAR NET

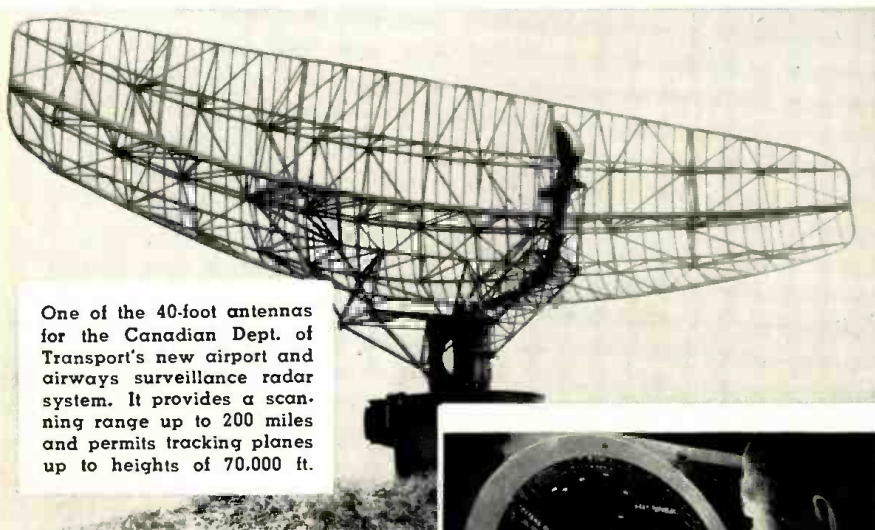

One of the 40-foot antennas for the Canadian Dept. of Transport's new airport and airways surveillance radar system. It provides a scanning range up to 200 miles and permits tracking planes up to heights of 70,000 ft.

**A CONTRACT** for a coast-to-coast commercial airways radar system has been awarded to Raytheon by the Canadian Government as part of its comprehensive program of transcontinental airport development and air traffic control, specifically aimed at equipping Canada's airways for the coming of the jet age.

The equipment, which will be installed at 15 major airports, consists of Raytheon's newly-developed AASR units which will permit each airport to track large commercial airliners within a radius of up to 200 miles. Because Canada's principal airports, with one exception, are no more than 400 miles apart, the overlapping patterns of radar surveillance will provide almost coast-to-coast coverage.

The new equipment permits the operator to select either linear or circular polarization of the radar signal, depending upon weather conditions. The circular polarization technique is much like putting "english" on a billiard ball. When the "twisting" microwaves strike the storm cloud, millions of spherical raindrops bounce them back to the antenna with a reverse twist. Their path to the receiver is blocked by an electronic filter so that they cannot register on the radar scope.

When the microwaves strike the irregular surfaces of a solid object, such as a plane, many of them return to the antenna, retaining their original twist.



Operator views image on the Raytheon radar screen. Geographic indications which permit operator to pinpoint positions of planes, are electronically superimposed on face of radar scope by flipping switch. New radar simplifies detection of planes because of system's built-in ability to select and reflect only moving objects, while filtering out fixed objects such as buildings, mountains, etc.

Thus they pass unhindered through the electronic filter to the receiver and register as targets on the scope.

Another feature of the new system is "moving target indication" which selects only moving objects to be reproduced on the screen. Reflections from buildings, mountains, and other intervening obstructions are filtered out.

An electronically generated map of the territory over which the plane is flying can be superimposed on the face of the scope and become visible merely by flipping a switch.

Delivery of the new units will begin early in 1958. —30—

## TUBES FOR THE FINEST IN HI-FI

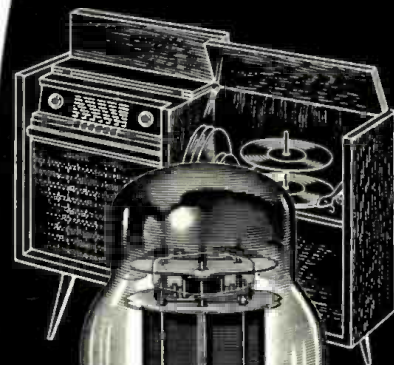

**TUNG-SOL**

Almost without exception, makers of the finest high-fidelity sets depend upon Tung-Sol Audio Amplifier Tubes to help deliver the performance expected of their products.

Through these tubes—the "5881" and the "6550"—Tung-Sol clearly demonstrates its ability to meet and maintain high-fidelity's critical design requirements in volume production.

This achievement is indicative of the quality and dependability of Tung-Sol Hi-Fi, Radio and TV Tubes . . . products of America's largest independent electron tube manufacturer, Tung-Sol Electric Inc. Newark 4, N. J.



**TUNG-SOL®**  
ELECTRON TUBES

## Tung-Sol Automotive & Electronic Products

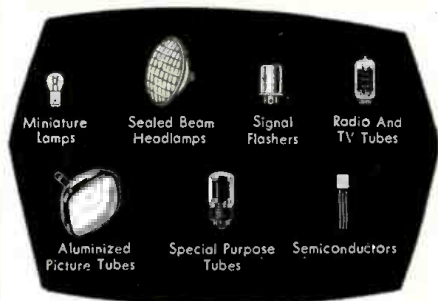

Miniature Lamps

Sealed Beam Headlamps

Signal Flashers

Radio And TV Tubes

Aluminized Picture Tubes

Special Purpose Tubes

Semiconductors

## SAVE HOURS OF WORK



quickly make round, square, key and "D" openings with Greenlee Radio Chassis Punches

In 1½ minutes or less you can make a smooth, accurate hole in metal, bakelite or hard rubber with a GREENLEE Punch. Easy to operate . . . simply turn with an ordinary wrench. Wide range of sizes. Write for details. Greenlee Tool Co., 1887 Columbia Ave., Rockford, Ill.



## E-Z WAY TOWERS

Looking for a tower that is easy to erect yet strong enough to withstand severe winds? This is it! E-Z Way Towers will stand a wind load of 40-60 lbs. per sq. ft. And with the new E-Z Way portable gin pole it's easy to erect a 120 ft. tower in one piece **without leaving the ground.** Unbelievable, isn't it? But E-Z Way Towers have been tested and proven. Thousands of E-Z Way Towers are giving outstanding service in all parts of the country and abroad. That's why E-Z Way is the Industry's New Leader. Find out about E-Z Way now!

SEND TODAY FOR  
FREE CATALOG

Dept. CN  
E-Z WAY TOWERS  
P. O. Box 5491, Tampa, Florida

Send me your FREE catalogue on the following towers:

AM Radio       Television  
 Ham Radio     Two-Way Communication

I am interested in a tower . . . . . ft. high.

I will use a (State type and model) antenna.

Type of Rotor . . . . .

Name . . . . .

Address . . . . .

City . . . . . State . . . . .

**E-Z WAY TOWERS Inc.**  
P. O. Box 5491 • Tampa, Fla.  
Telephone 4-2171



### TWO NEW U.H.F. ARRAYS

JFD Manufacturing Co., Inc., Brooklyn 4, N. Y., announces the addition of two new antenna arrays to its u.h.f. line.

The new all-aluminum corner reflector model UHF410 features permanent rust and corrosion resistance.

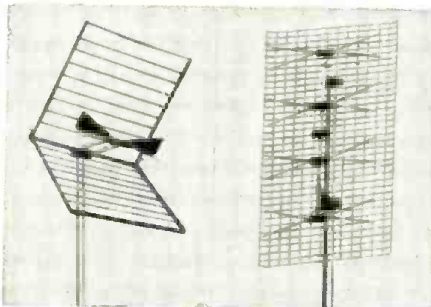

A solid aluminum inline dipole creates proper wavelength relationships with reflector assemblies for maximum u.h.f. gain. The entire unit is factory assembled. The service technician just flips it open and mounts it on a mast. High front-to-back and front-to-side ratios minimize co-channel and adjacent channel interference.

The second new addition, the u.h.f. 4-Stack Bowtie Model No. UHF202 features a new super-rigid, 1-piece pre-assembled design. The response of this antenna may be peaked to the desired u.h.f. channels. An accurately spaced and cut phasing harness creates maximum u.h.f. stacking gain ideal for fringe area reception.

### NEW FRINGE ANTENNA

Brach Manufacturing Corp., 200 Central Ave., Newark 3, N. J., is introducing a new broadband v.h.f. antenna, the "3V", model 5603. This antenna has been designed to perform as a high-gain u.h.f. antenna in primary areas and as a fringe antenna for v.h.f.

Manufacturer's gain curves show an average gain of 7 db on the low

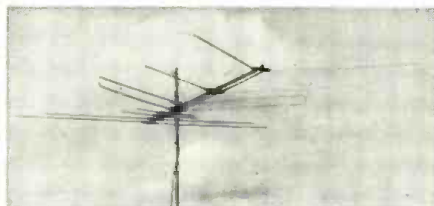

v.h.f. channels and 15 db on the high channels. Sharp directivity is claimed.

The antenna features aluminum construction and snap lock design.

### TWO HIGH-GAIN ANTENNAS

The Finney Company, 4612 St. Clair Ave., Cleveland, Ohio, announces the addition of the models B-6 and B-7 to its "Finco Geomatic" antenna line.

Both of these antennas give high gain over a broad band, and feature high front-to-back ratio.

The model B-6 antenna uses four coaxial capacitors in one folded dipole, causing the dipole to act as if it were one length on the low band and another length on the high band. In addition, a low-band reflector, a high-band colinear reflector, and a combination director further increase the gain and directivity.

The model B-7 features two 3-element colinear directors and an inductance-tuned low-band director in addition to the elements used for the B-6.

These antennas are shipped either single bay or stacked.

### ANTENNA PIONEER HONORED

Telrex Laboratories, Asbury Park, N. J., and its president, Michael D. Ercolino, were the subjects of a recent story in a New Jersey business magazine. The company itself received

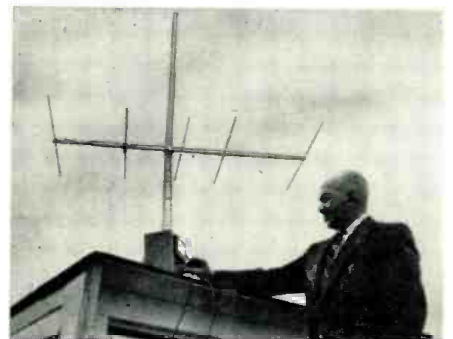

recognition as one of the outstanding industrial firms of New Jersey.

Some of the pioneering advances in the antenna art made by Mr. Ercolino, who was referred to as "Mr. Antenna", were described.

### TV TRANSMISSION WIRE

Channel Master Corp., Ellenville, N. Y., has introduced a new television transmission wire called "Copper-

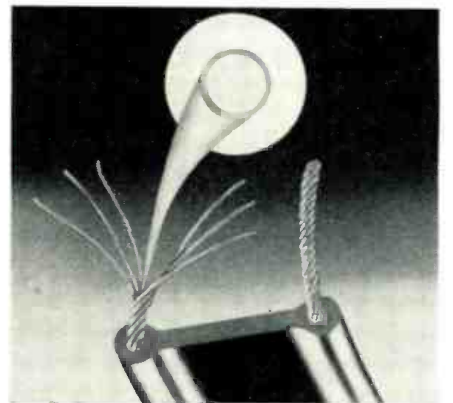

Jac". This new twin-lead features conductors of Copperweld, a special type of wire which has a core of steel and a coating of pure copper. This results in conductors which have extraordinary high strength as well as high conductivity.

"Copper-Jac" is insulated in pure polyethylene and is available in three colors, brown, silver, and black. It contains 7-strand conductors of No.

28 or No. 30 Copperweld wire. This lead-in is also furnished with a choice of web thicknesses and comes in 1000-foot lengths, either on a spool or in a "Feeder-Pak".

### 2-METER AMATEUR ANTENNA

Skysweeper, Inc., McHenry, Ill., now has available a low-cost 2-meter amateur radio beam antenna, the model HM2-10AK, 5-over-5 yagi, sold by distributors for \$12.95 net.

This antenna is cut to 146 mc. and covers 144-148 mc. The s.w.r. at reson-

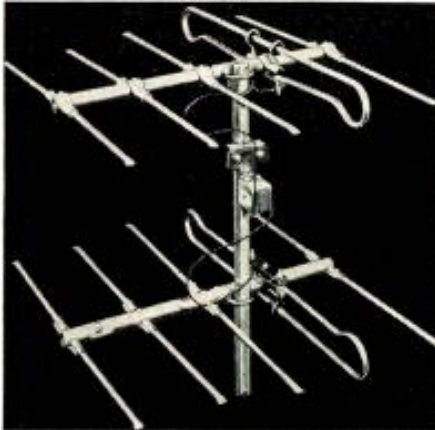

ance is 1.1 or less. All interconnecting harness is 1 kilowatt twin-lead, terminating in a SO-239 coaxial socket mounted in a weather-resistant connector box. The antenna can be fed from any length of 52-ohm coaxial cable. It can be mounted vertically or horizontally.

### 10-METER ROTARY BEAM

Mosley Electronics, Inc., 8622 St. Charles Rock Road, St. Louis 14, Mo., has just announced a new high-gain, low-cost, ten-meter rotary beam antenna. The "Super Ten" is a three-

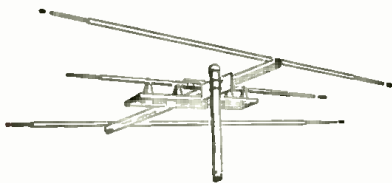

element beam using  $\frac{1}{2}$  wavelength director and reflector elements teamed with a shortened driven element to permit the use of a coupling transformer. This coupling system is simple, convenient, and exceptionally efficient as a match for 52-ohm line.

Performance figures on the new antenna include: 7.9 db gain, 20 db front-to-back ratio, 1.2 to 1 s.w.r. at resonant frequency. The maximum element length is 17 feet, 3 inches; the boom is 8 feet, 4 inches. The weight is 20 pounds.

### MAST MOUNTING ACCESSORIES

Television Hardware Mfg. Co., Rockford, Ill., has two new products: a TV antenna mast mount with a ratchet grip and a wall mount providing 7-inch wall clearance.

The new "Telco" ratchet mount can be used on any type of chimney or similar support where a strap is em-

ployed. It will fit all masts up to  $1\frac{1}{4}$ " in diameter. It is made of heavy gauge steel, double plated to prevent rust, and is supplied with 24 feet of strapping.

For installation, the service technician just slips both ends of the strap

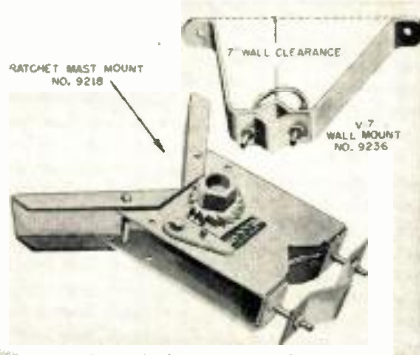

through the ratchet bolt slots and then uses a wrench to tighten the strap.

The new TV antenna mast wall mount is the "Telco" model "V-7". It is constructed of heavy gauge steel, zinc plated, and comes completely assembled.

### IMPROVED V.H.F. BOOSTER

Blonder-Tongue Laboratories, Inc., 526-536 North Ave., Westfield, N. J., is delivering a greatly improved broadband v.h.f. amplifier, the model CA-1. This booster now features over 26 db gain on the low band and 24 db on the high band, according to the manufacturer. It is also claimed that the response curve of the unit is flat



within  $\pm 2$  db over the entire v.h.f. band.

The total peak output of the four-triode tube circuit is .7 volt for 75 ohms and 1.4 volts for 300 ohms. A built-in 14 db gain control is included. The fused power supply operates from any 117 volt, 60 cycle a.c. source.

### ANTENNA SALES AID

In order to help promote the sale of the company's "Venus" indoor antenna JFD Manufacturing Co., Inc., 6101 16th Avenue, Brooklyn 4, New York has prepared an attractively lithographed, three-color easel display.

Designed to be used in either a show window or on a counter, the merchandiser is said to stimulate traffic sales of indoor antennas. The merchandiser is being supplied without charge by the company or its distributors. -30-

## Examine FREE



Edited by W. L. EVERITT

5 VOLUMES 1662 ILLUSTRATIONS

Pay Easy Installments If You Keep the Set

Turn to this new, up-to-date Library with complete confidence, for dependable facts on any phase of modern electronic theory and practice. These volumes, by outstanding authorities, give you thorough guidance—clearly written, logically arranged, profusely illustrated.

### Electronic Fundamentals and Applications

By Prof. John D. Ryder, Dean, College of Engineering, Michigan State College

Complete, logical, easy-to-follow treatment of (a) physical principles underlying electron tubes, (b) characteristics of vacuum tubes, (c) all basic tube circuits. Includes: Electron Ballistics, Cathode-Ray Tubes, Emission of Electrons, Space Charge in Vacuum Tubes, Diode Rectifiers, Triodes, Multi-Element Tubes, Small-Signal Amplifier Circuits, Audio-Frequency Amplifiers, Radio-Frequency Amplifiers, Oscillator Circuits, Modulation Systems, Wave-Shaping Circuits, Gaseous Conduction, Gas Diodes, Gas Control Tubes and Circuits, Photoelectric Cells, Solid-State Electronics.

### Electromagnetic Waves and Radiating Systems

By Prof. Edward C. Jordan, Head, Dept. of Electrical Engineering, Univ. of Illinois

Covers entire field of electromagnetic engineering. Includes propagation as well as radiation and transmission. Full treatment of UHF transmission lines, wave guides, antennas, slot antennas, radiation and diffraction, ground-wave and sky-wave propagation.

### Ultra High Frequency Engineering

By Thomas L. Martin, Head, Dept. of Electrical Engineering, Univ. of Arizona

Theory and technique of ALL the new fields of electronic engineering: Radar, Telemetering, Electronic computing, Facsimile, Television, Blind landing systems, Pulse-time modulation, Ionosphere measurements . . . and the others.

### Networks, Lines and Fields

By Prof. John D. Ryder, Dean, College of Engineering, Michigan State College

Network transformations and theorems. Resonance, impedance transformation and coupled circuits. Filters. General transmission line. High-frequency line. Equations of the electromagnetic field. Radiation. Transmission and reflection of plane waves at boundaries. Guided waves between parallel planes. Wave guides.

### Elements of Television Systems

By George E. Anner, Univ. of Illinois

Complete basic theory. Plus current practice, covering: Closed TV systems. Commercial Teletexting Systems. Color TV Systems. Gives clear exposition of all phases of picture transmission, including the new technique of dot interlace.

## SEND NO MONEY—EXAMINE FREE

Just mail coupon below to get complete 5-Volume Set on 10 DAYS' FREE TRIAL. If not completely satisfactory, return in ten days and owe nothing. Or keep the set and pay only \$7.50 down and \$8 a month for five months until full price of \$47.50 is paid. Or I will return the Library in ten days and owe nothing.

Prentice-Hall, Inc., Dept. 5741-J1  
Englewood Cliffs, N. J.

Send me the Prentice-Hall ELECTRONICS & UHF LIBRARY (5 Volumes) for ten days' free examination. If fully satisfied in ten days I will send you \$7.50 plus few cents postage and then \$8 a month for five months until full price of \$47.50 is paid. Or I will return the Library in ten days and owe nothing.

Name .....

Address .....

City and State .....

Choose from these

# JACKSON

# 3

## "Service Engineered" TUBE TESTERS

**1** New Features!  
**Model 648P**  
**Dynamic**  
**\$114.95 net**

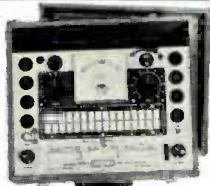

Fastest Dynamic Tube Tester made, yet it's fully flexible for all receiving types, new and old. The set-up time is actually less than the warm-up time of the tube. New Variable Sensitivity Shorts Test shows leakage up to 2.0 megohms. Metered plate current shows tube condition. Meter calibrated in Good-Bad as well as Percent of relative micromhos. Automatic Line Voltage Indicator, Life Line Indicator, New Zig Zag Roll Chart locates tube types much faster, TV types separated for even faster locating.

**2** Low-Cost  
**Forty-Niner**  
**with Plug-In**  
**Accessories**



**\$49.95 net, Accessories extra**



A good, basic tube tester, with plug-in accessories for performing a wide variety of additional tests. Accessories may be added any time, permit testing tubes for filament current and high resistance shorts, as well as checking selenium rectifiers. Lever action shows which pins are connected. Sensitive shorts test. Line Voltage Indicator. A tremendous value.

**3** New, Portable  
**Dynamic**  
**Model 561**  
**\$89.95, net**

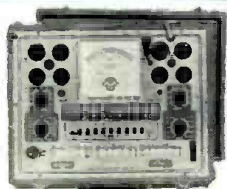

Employs famous Jackson Dynamic principle, applying separate voltages to each tube element. High voltage power supply for most accurate tests. Improved switching system gives simplified, fast operation. Filament voltages for the very latest TV types. Fully portable case finished in harmonizing gray and green, tough plastic fabric. Built-in roll chart, with free replacement service for one year.

Test Data on New Tube Types for All Jackson Testers Appears Monthly on Page 65 of PF Reporter

For more information, write:

# JACKSON

ELECTRICAL INSTRUMENT CO.

"Service Engineered" Test Equipment

16-18 S. PATTERSON BLVD., DAYTON 2, OHIO  
In Canada: The Canadian Marconi Company

## The Tube Racket

(Continued from page 41)

to the manufacturer for a new tube. If this practice is followed, there will be no tubes available to the illegal operator.

One point that should be clear is that the rebranded tubes discussed in this article have nothing to do with so-called manufacturer's "seconds," that is, those tubes which do not come up to specifications at the time of manufacture and are discovered on the production testing line. These tubes are destroyed in the plant and although rebranders have made attempts to obtain them, the manufacturers have been successful in keeping this possible source of supply closed. Rebranded tubes should also be distinguished from tubes which are sold as surplus. These, in almost all cases, are new tubes obtained from electronic equipment manufacturers who may

have gone bankrupt or out of business, or have changed the design of their equipment, had an overrun, etc. Since equipment manufacturers obtain new tubes from tube manufacturers at extremely low cost, they, in turn, can resell these tubes, when necessary, at far below list price. Thus, such tubes are resold to users at bargain prices. These, however, are good tubes and this type of operation is strictly legitimate. -30-

## BRASS POUNDERS' HAMFEST

**T**HE South Hills Brass Pounders and Modulators, Inc. will hold its 18th Annual Hamfest Sunday, August 5th at Totem Pole Lodge, South Park, Pittsburgh.

The affair will start at noon with entertainment provided for the whole family. Those registering before July 21st will be charged \$1.50 a ticket with \$2.00 collected at the gate.

Reserve with S. J. Zolinas, W3QWW, 423 Parkwood Road, Pittsburgh. The club station, W3PIQ, on 29.2 mc. will be used to "zero" the mobiles. -30-

## The Easy Way

(Continued from page 39)

builds friendship and understanding on an international as well as a national basis, but because it is an all-age avocation. Long after a man has been advised to taper off on his tennis and golfing activities, he can still continue his "armchair" traveling via the airwaves.

Bill's interest in hamming led directly to his studying engineering and his stint on the MARS station at Duke is earning him time credit for his undergraduate Air Force training. Needless to say, his Dad is well pleased, for although he is, himself, a freelance photographer by profession, his hobby has such a hold that it is gratifying to know that the indoctrination "took" with his son.

The author, currently president of the Sarasota Amateur Radio Association, invites visiting hams to look in on one of our monthly meetings if they are in the neighborhood. We meet the second Thursday of each month at the Sarasota County Courthouse. -30-

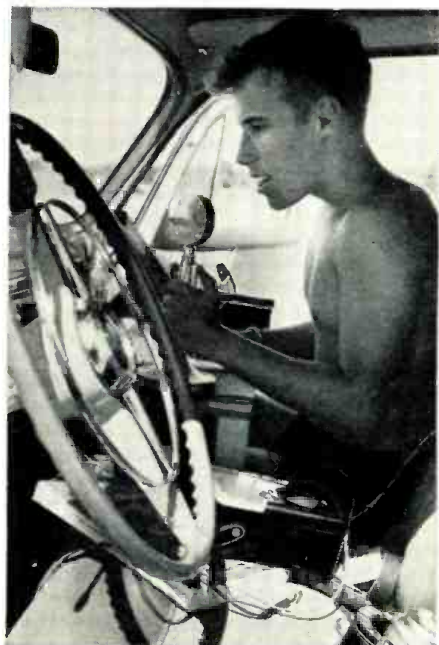

Bill Steinmetz, W4TFP, at mike of W4YI's mobile transmitter during the ARRL's 1955 field day contest. They placed third in the mobile category during 24-hour meet.

Interior of W4YI and W4TFP's ham shack with the author at the mike. Note the great circle map, the 24-hour clock, and all the other operating conveniences.





**Protection System**  
(Continued from page 54)

plies the necessary voltage (obtained from the main chassis) to operate the test motor.

With such an arrangement, the line between the guard panel and the main chassis may be well over a mile in length.

**Special Features**

Since only two wires, plus an earth ground, are required for the operation of the system, an ordinary leased telephone line may be used to connect the guard panel and the main chassis. In an emergency, permission can generally be obtained from the local telephone company to use an existing connection between a protected area and the guard room.

Excessive air turbulence may cause a shift in frequency of the ultrasonic waves in the same manner that a moving body does. Because of this, air turbulence resulting from even a tiny flame will cause an alarm. The protection system thus serves to give an alarm in case of fire as well as protection against an intruder.

**Installation Techniques**

The ease of installation can be best emphasized by the following summarized installation procedure:

1. The carrying case is opened and the guard panel and main chassis removed.
2. The main chassis is placed near a convenient power outlet and connected to an earth ground.
3. The two halves of the carrying case are separated and placed against opposite walls of the room to be protected.
4. The special plug-in cables supplied for interconnecting the units are connected.
5. The main chassis is turned on and sensitivity adjusted.
6. The guard panel is taken to the guard room, and the coil of line supplied unrolled and used to connect the guard panel and the main chassis (both ends of the line are "plug-in"). If more line is necessary, additional telephone line can be spliced in, or a leased line used instead. The guard panel is connected to an earth ground and plugged into a power outlet in the guard room.
7. The system is ready for operation.

To adjust the sensitivity without connecting the guard panel, the tuning eye on the main chassis is used. When the main chassis is "set up" for nor-

Fig. 5. How the sensitivity of the completed protection system is adjusted. See text.

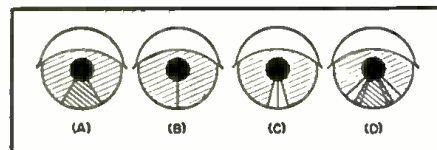

July, 1956

When signal conditions demand a **TOWER...**  
choose one built by **AERMOTOR**

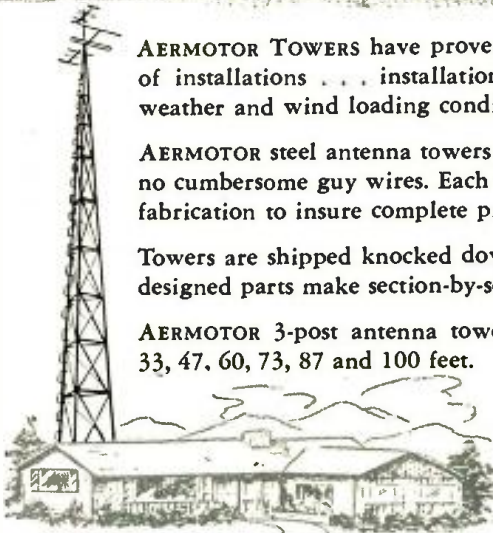

AERMOTOR TOWERS have proven their excellence in thousands of installations . . . installations exposed to the most severe weather and wind loading conditions.

AERMOTOR steel antenna towers are self supporting . . . require no cumbersome guy wires. Each part is heavily galvanized after fabrication to insure complete protection from exposure.

Towers are shipped knocked down in convenient bundles; well designed parts make section-by-section assembly easy.

AERMOTOR 3-post antenna towers are available in heights of 33, 47, 60, 73, 87 and 100 feet.

WRITE FOR ADDITIONAL INFORMATION ABOUT THE AERMOTOR TOWERS AND A DEALER FRANCHISE IN YOUR TERRITORY.

SINCE 1888, MANUFACTURERS OF QUALITY BUILT TOWERS

**• AERMOTOR COMPANY**

2500 W. ROOSEVELT RD.—CHICAGO 8, ILLINOIS, U.S.A., DEPT. 13U7

NEW  
\*Industrial Mobile Phone  
**KAAR IMP\***



Opens new markets for industrial radiotelephone sales.

Complete unit **ONLY \$328.**



Key dealerships open. Write for details.  
**ENGINEERING CORP.**  
2921 Middlefield Rd. Palo Alto, California

**COYNE**  
TRAINS YOU IN SPARETIME AT HOME  
COYNE QUALITY TRAINING AT LOWEST COST  
**TELEVISION**  
RADIO-COLOR TV

Only from famous COYNE do you get this modern up-to-the minute TV Home Training. Easy to follow instructions—fully illustrated with 2150 photos and diagrams. Not an old Radio Course with Television tacked on. Includes UHF and COLOR TV. Personal guidance by Coyne Staff. *Practical Job Guides* to help you EARN MONEY QUICKLY IN A TV-RADIO SALES AND SERVICE BUSINESS—part time or full time. COSTS MUCH LESS—pay only for training—no costly "put together kits."

**SEND COUPON FOR FREE BOOK**  
SEND COUPON BELOW for Free Book and full details including EASY PAYMENT PLAN. NO COST OR OBLIGATION—NO SALESMAN WILL CALL.

B. W. COOKE, Pres. **COYNE** FOUNDED 1899  
**ELECTRICAL SCHOOL**

A TECHNICAL TRADE INSTITUTE OPERATED NOT FOR PROFIT  
500 S. Paulina Dept. B5-HT5 Chicago 12, Illinois

**COYNE ELECTRICAL SCHOOL**  
Television Home Training Div.  
500 S. Paulina St., Chicago 12, Ill., Dept. B5-HT5

Send FREE BOOK and details of your Television Home Training offer.

Name \_\_\_\_\_  
Address \_\_\_\_\_  
City \_\_\_\_\_ State \_\_\_\_\_

# SOUND ADVICE!

## New Isophon ELECTROSTATIC TWEETERS

Easily included  
in your present circuits!

- ★ Better performance in higher frequencies (7000-20000 cycles)
- ★ Compact, space-saving
- ★ Substantially lower cost
- ★ Remarkable brilliancy of sound



ST H 5/16  
Size:  
1.97" x 6.30"  
Thickness:  
0.787"

ST H B 7  
Diam: 2.76"  
Thickness:  
0.55"

Write for details  
and spec. sheet R-7

**Arnhold** ARNHOLD  
CERAMICS, INC.

1 E. 57th Street, New York 22, N. Y.

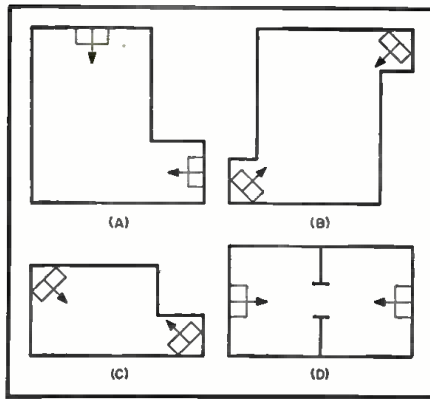

Fig. 6. Various methods of setting up the system to accommodate odd-shaped rooms.

mal operation (not in alarm), the eye is open, as shown in Fig. 5A. When there is sufficient body movement to cause an alarm, the eye closes, as in Fig. 5B. Greater body movement causes the eye to overlap (Fig. 5C). Excessive air turbulence causes the eye to "flutter" (Fig. 5D).

The sensitivity control ( $R_5$  in Fig. 2) is adjusted until the desired degree of

body movement anywhere within the protected room causes the eye to close. Normally, the adjustment is such that waving a hand will not cause an alarm, but an attempt to take a step or to "creep" immediately initiates an alarm.

Where the room is not a simple rectangle or square, but odd-shaped, reasonable care must be exercised in locating the transducers (in the carrying case "halves"). Examples of good locations are given in Fig. 6.

Note: Both transducers and other special components used in this unit are available from *Walter Kidde & Co., Inc.*, 717 Broadway, Newark, N. J.

### Acknowledgements

Although the author was responsible for the design of the portable ultrasonic protection system in the form described, the basic ultrasonic alarm system was designed by Sam Bagno of New York, and he holds the patents on the system. The basic system was described by Stanley Kempner in an article in the April 1952 issue of *Electronics* under the title "Ultrasonic System Detects Intruders." -30-

### ADAPTER CONNECTS PHONO PLUG TO MIKE INPUT

By ARTHUR TRAUFFER

USING parts out of his radio "scrap boxes," the writer made a neat little adapter that will connect a low-output phono pickup to a high-gain mike input on his amplifier. This simple adapter is completely shielded, and many uses will be found for it in experimental work.

For the body of the adapter, any tin can with a friction lid or screw-on lid can be used providing it is large enough in diameter to take the phono jack. The writer used a Doan's pill can, but a bouillon cube can could have been used instead. Aluminum cans are too difficult to solder to.

As shown in drawing below, saw off the front end of a standard female mike connector as indicated by the dotted lines. Next, using a fine-toothed narrow-blade hacksaw, saw off the can to give you a 1/2"-long bottom section. Lay the bottom section of the can on a hardwood block and chop out a 1/2" diameter hole in the bottom using a narrow chisel or sharpened blade of a small screwdriver. Scrape the inside of the can bottom clean and solder the mike connector into the bottom, as shown.

To mount the phono jack inside the lid of the can, drill the usual three holes and mount the jack in the same manner you would mount it on a chassis. Be sure that you scrape the inside of the can lid clean so the jack will make good contact with it.

Now all we need to do is put the can tin onto the can bottom, and solder the center lug of the phono jack into the center contact hole in the mike connector. The writer simply cut the end of the phono jack lug to a point, so that when the can was put together the phono jack lug projected into the center hole of the mike connector so it could be soldered securely. However, if the center lug on your phono jack is too short to do this, you will have to use a short length of connecting wire as usual.

To insure that the two parts of the can make good electrical contact with each other, scrape off a little enamel near the bottom rim of the can where the two parts of the can join, and then apply a drop of solder.

The photo below shows the completed adapter in use. -30-

Mechanical details for constructing the compact adapter and photo of complete unit.

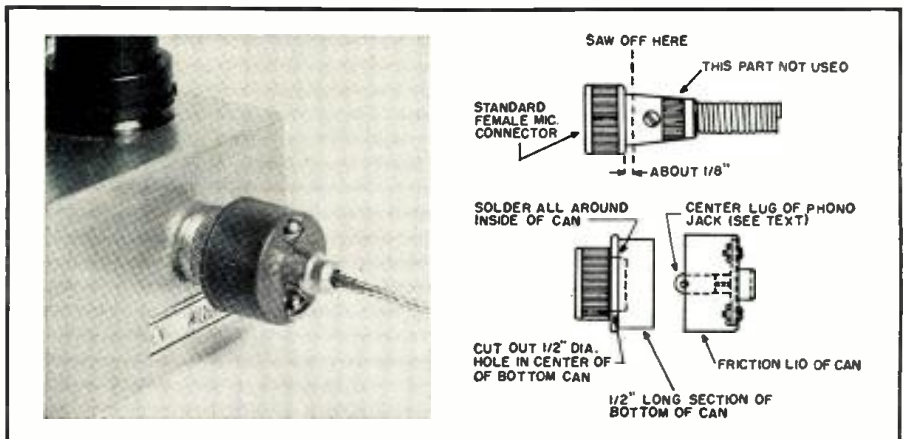

# Electronic Latching Relay

By RUFUS P. TURNER

*A sure and simple circuit for providing lock-in relay action.*

FIG. 1 is the circuit of a simple lock-in type of relay. A transient  $1\frac{1}{2}$ -volt pulse will close the relay, the latter remaining closed (subsequent pulses having no effect on it) until switch, *S*, is opened momentarily. *S* may be a normally-closed push-button switch.

The circuit operates in the following manner. When switch *S* is closed,  $67\frac{1}{2}$  volts from a d.c. supply, connected to the two lower terminals, are impressed upon the neon lamp through the relay coil and the secondary of the transformer in series. However, this voltage is too low to fire the neon, no current flows in the circuit, and the relay remains open.

A  $1\frac{1}{2}$ -volt, 50 ma. pulse applied to the signal input terminals induces a voltage across the secondary of the transformer. This voltage acts in series with the  $67\frac{1}{2}$  volts and momentarily raises the circuit voltage high enough to fire the neon. The resulting current closes the relay. After the pulse passes, the circuit voltage falls back to  $67\frac{1}{2}$  volts but the lamp does not extinguish because once it has been fired, it will continue to glow until the voltage falls to a critical value around 55 volts. The relay therefore continues to hold-in and will do so until switch *S* is opened momentarily to interrupt the current.

The neon is fired by the end, not the start, of the pulse. Polarities of the transformer and  $67\frac{1}{2}$ -volt supply do not affect the operation.

While the author used a *Sigma* 4-F d.c. relay (8000 ohms, 1.6 ma.) any similar type with a 1- to 3-ma. rating can be used successfully. It has been found that the S-14 (with the terminals selected according to the numbers in Fig. 1) is not the only transformer that will work. Any model with a step-up turns ratio between 10:1 and 20:1 will do. Thus, a small carbon mike transformer is just right. —30—

Fig. 1. Diagram of electronic latching relay.

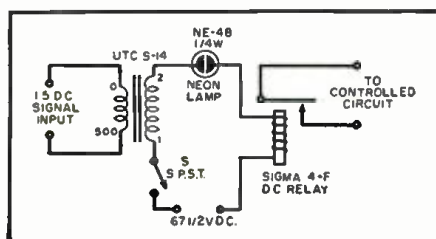

July, 1956

## INDEPENDENT SCIENTIFIC SURVEY AND LAB TESTS PROVE PRECISE MODEL #111---"BEST COMMERCIAL TUBE TESTER AT ANY PRICE"...



Now You Can Check Tubes  
The Manufacturer's Way

- Checks both emission and mutual conductance
- Checks all tubes including hearing aid, miniatures
- Six different plate voltages
- Different grid signals
- Simplified Short check
- Gas check
- New type switches
- Deeply etched aluminum panel
- Three different screen voltages
- Latest roll chart
- Measures filament current
- Measures grid bias

**precise**  
Model #111

111K (kit form) **NOW ONLY \$79<sup>95</sup>**  
111W (factory wired) ..... \$139.95  
incl. carrying case and cover

### Mutual Conductance and Emission TUBE TESTER

An independent scientific survey conducted by an impartial testing laboratory confirms what purchasers already know: "The most advanced, the most complete tube tester and the best priced is made by PRECISE DEVELOPMENT CORP., Oceanside, N. Y."

**CHECK THESE ADDITIONAL 'specs' . . . TALK TO YOUR JOBBER  
AND TO ANYONE WHO HAS THIS OUTSTANDING TUBE TESTER . . .**

The Model 111 is the only single commercial tube tester that checks all tubes for both EMISSION and MUTUAL CONDUCTANCE separately. Filament current is measured directly on large meter when checking a VOLTAGE SAPPER tube. NEW, MODERN DESIGNED ROTARY SWITCHES allow you to check each tube element individually. NEW TYPE Single Rotary switch for complete short checks. The 111 makes all BIAS,

FILAMENT VOLTAGE, GAS, LIFE checks visually on large meter . . . 5 individually calibrated ranges and scales for mutual conductance tests. NEWLY DESIGNED "NO BACKLASH" ROLL CHART lists all tubes including the new type 600 mil series tubes. Provisions are made for testing many color tubes. All CRT's can be checked with accessory adaptor, Model PTA.

**ASK YOUR DISTRIBUTOR ABOUT THE FAMOUS MODEL #116 QUICK-TEST VERSION  
OF THE MODEL #111 . . . TESTS 5 TUBES IN 4 SECONDS EACH . . . ACCURATELY**

**precise** DEVELOPMENT CORP., OCEANSIDE, NEW YORK

### KIT FANCIERS! Now You Can Have...

- PROFESSIONAL CONSTRUCTION
- ACCURATE PERFORMANCE DATA
- CONVENIENCE

The Miami Instrument Company now offers expert construction of electronic kits where this service is not available from the supplier. ORDER THROUGH US! Your completed kit will be sent to you postpaid, accompanied by accurate performance data, guaranteeing confidence in the equipment. Specify manufacturer, model and send only cost of kit plus 60%. This offer does not include receivers.

**MIAMI INSTRUMENT COMPANY**  
Dept. K, P.O. Box 384, Miami 44, Florida

### EASY TO LEARN CODE

It is easy to learn or increase speed with an Instructograph Code Teacher. Affords the quickest and most practical method yet developed. For beginners or advanced students. Available tapes from beginner's alphabet to typical messages on all subjects. Speed range 5 to 40 WPM. Always ready—no QRM.



**ENDORSED BY THOUSANDS!**

The Instructograph Code Teacher literally takes the place of an operator-instructor and enables anyone to learn and master code without further assistance. Thousands of successful operators have "acquired the code" with the Instructograph System. Write today for convenient rental and purchase plans.

**INSTRUCTOGRAPH COMPANY**  
4711 SHERIDAN ROAD, CHICAGO 40, ILLINOIS

123

**SPECIAL VOLTMETER**  
**BRAND NEW ROLLER SMITH 2 1/2" \$1.95**  
 18-36 VDC.

**SMALL PIONEER GENEMOTORS**  
 Ideal for Amateur or Commercial Service 5.5 to 6 volt DC input-output 450 volts at 175 MA cont. or 275 MA intermittent duty. Comes complete with A & B filters. RF hash filter & internal cooling fan.....each **\$19.95**  
 Same as above with 11.5 to 12 volt DC input.....each **\$12.95**

**DYNAMOTOR STARTING RELAY**  
 12V DC coil. Solenoid type fully enclosed. Will easily handle 50 amps. Contacts and winding isolated from ground.....ea. **\$1.75**  
 2 for **\$3.00**

**CRYSTAL MICROPHONE ELEMENT**  
 Crystal element mfd. by Brush Develop. Co. Excellent fidelity. Each element indiv. tested. Built for Ham use. PA systems, home recorders of any sound recording or transmission.....ea. **98c**  
 Size: 1 1/2" Sq. Make your own microphone.....ea.

**1" MINIATURE METER**  
 High quality meter made by International Instrument Co. Mounts in a 1" hole like a pilot light. Basic movement 0-10 mills. Can be shunted to any milliamperage range.  
 0-10 Mil. Special..... **\$2.95**

MS 1" Miniature Meter ..... \$3.95  
 Filament Transformer Pri. 110V. 60 cy. Sec. in 20 divisions..... \$3.95  
 Good quality..... \$1.95

**TELEPHONE HANDSET ELEMENTS**  
 Receiving and carbon microphone elements fit standard W.E. or Conn. Tel. handsets. 65¢ ea. or \$1.10 pr.

**G. E. RELAY CONTROL**  
 (Ideal for Model Controls, Etc.)  
 Contains a sigma midget 8,000 ohm, relay choke, bi-metal strip, neon pilot and many useful parts. The sensitive relay alone is worth much more than the total low price of... **\$1.25 ea.** 10 for **\$9.90**

**SENSITIVE RELAY**  
 5000 ohm coil operates on 1 ma. adjustable contacts. adjustable armature tension. SPDT. Bakelite base. Ideal for model work. Can also be used on AC. Drive 1/2 amp. 110 V. 60 cy. 4 mill AC @ 110 V. Ideal for burglar alarm..... \$ for **\$7.50**

**UNIVERSITY MM2 SPEAKER**  
 Weatherproof and waterproof reflex type speaker. Many industrial and commercial applications. Capacity 15 Watts, Impedance 16 ohms. List \$40.00. OUR PRICE..... **\$15.95**

**OIL CONDENSER SPECIALS**  
**BRAND NEW**

25 MFD 350 VDC \$1.25	1 MFD 3000 VDC 1.85
2 MFD 600 VDC .50	10 MFD 3600 VDC 2.25
4 MFD 600 VDC .75	10 MFD 750 VDC \$4.50
6 MFD 600 VDC .85	1 MFD 10,000 VDC 22.00
8 MFD 600 VDC .95	2 MFD 10,000 VDC 39.95
10 MFD 600 VDC 1.19	1 MFD 15,000 VDC 29.50
12 MFD 600 VDC 1.40	1 MFD 25,000 VDC 49.50
2 MFD 1000 VDC .85	5 MFD 330 AC (1000 DC) .95
4 MFD 1000 VDC 1.35	8 MFD 330 AC 2.50
8 MFD 1000 VDC 1.50	8 MFD 660 AC (2000 DC) 2.35
1 MFD 1200 VDC .45	10 MFD 660 AC (2000 DC) 2.75
2 MFD 1500 VDC 1.10	
6 MFD 1500 VDC 1.95	
10 MFD 1400 VDC 2.50	
1 MFD 2000 VDC .85	
2 MFD 2000 VDC 1.50	
4 MFD 2000 VDC 3.50	

**NEW PANEL METERS**  
 G.E., WESTINGHOUSE, W.E., SIMPSON, etc.

<b>1" METERS</b>	<b>0-150 MA RF</b>
1 1/2" 0-5 Amps DC	100 Thermos 3.49
RF with ext. Thermocouple 3.95	0-4 Amps R.F. 3.49
	0-9 Amps R.F. 2.99
<b>2" METERS</b>	<b>0-1 1/2 Milliamps</b>
0-100 Microamp \$3.95	15-0-15 Milliamps 3.95
0-5 Amps DC 3.95	0-10 Milliamps 3.95
0-10 Amps AC 2.95	0-50 Milliamp (1 Mil Basic) 3.95
0-35 Mil 2.95	0-300 Milliamp 3.95
0-200 Mil AC 2.95	0-15 Amps DC 2.95
10-0-10 Amps 2.95	0-10 Mil AC 3.95
0-15 Volts AC 3.95	0-5 Amps AC 3.95
0-300 Volt AC 3.95	

**BUD CE2008**  
 Variable Condenser. Insulating insulation. Air gap. Capacity 300 MUF. Res. net \$4.05 ea. OUR PRICE..... **\$1.65**

**TURNER DYNAMIC MICROPHONE**  
 Model 22D-200 ohm imp. Freq. response 75-9000 cy. Complete with desk stand..... **\$14.95**  
 and shielded cord. BRAND NEW.....

**METER SPECIAL**  
 3 1/2" Sq. Bakelite cased meter. Scale 0-150 MA. Basic 0-1.5 MA. We supply.....ea. **\$3.45**  
 wire.....

**Read 'n' Save Bargains**  
 500 MMF CERAMIC CONDENSERS... 10 for 5.50  
 NAT. EMC VAR. COND. 250 MMF... 1.25 ea.  
 SANGAMO F2L .001 5000 VOLTS WORKING-TRANSMITTING TUBA CONDENSER... .75  
 HEINEMANN CIRC. BREAKER  
 110 V. 40 cy. 20 amps. Curve 4..... 1.25  
 .01 MMF 1000 VDC MICAS..... 5 for 1.50  
 .01 MMF 2500 VDC MICAS..... 5 for .95  
 .0014 2500 VDC MICAS..... 5 for .95  
 .025 600 V. MICAS..... 5 for .95  
 100,000 OHM. 100 WATT RESIST..... .45  
 RELAY 6 VOLT DC UNIT..... 1.25 ea.  
 RELAY 12 VOLT DC UNIT..... 1.25 ea.  
 1 MFD Oil Condenser 400 VDC..... 10 for 1.50

All merchandise sold on a 10 day money back guarantee basis  
 Min. Order \$3.00-25% with Order-F.O.B. New York

**PEAK**  
 ELECTRONICS COMPANY  
 66 W. Broadway, New York 7, N.Y., WO-2-5439

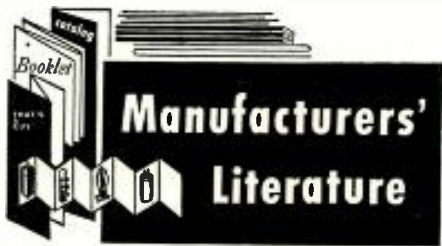

**LICENSING COURSES**

*Cleveland Institute of Radio Electronics*, 4900 Euclid Avenue, Cleveland, Ohio has issued an interesting 16-page brochure describing its home study courses leading to FCC tickets.

Both the master course in radio communication and the advanced radio communication and engineering courses are described in complete detail with an outline of the curricula.

A free copy of this publication will be forwarded on written request.

**PANEL METER DATA**

*Trio Laboratories, Inc.*, 4025 Merrick Road, Seaford, Long Island, N. Y. issued a short catalogue (No. VM-106) which describes its line of miniature, panel-mounting vacuum-tube voltmeters that are small enough to be built into operating or test equipment.

Both a.c. and d.c. models are described for commercial or military applications as is a new, low-level d.c. vacuum-tube voltmeter designed to meet military specifications.

**RESINS FOR ELECTRONICS**

*Minnesota Mining and Manufacturing Co.*, 900 Fauquier Street, St. Paul 6, Minn. has compiled a 4-page illustrated booklet describing its "Scotchcast" brand synthetic resin products for electrical use.

In addition to listing available resins, the booklet cites examples of typical applications with data on flexibility, viscosity, pot life, cure times, and available forms.

A full-page chart lists such data in handy, easy-to-use form. For a copy of this publication, make all requests to Dept. D6-81 of the company.

**RELAY BULLETIN**

Complete details on its new low-cost, general purpose relay (Style #15300) have been included in a bulletin just released by *Price Electric Corporation*, Frederick, Maryland.

The relay has been designed for such applications as search tune auto radios, automatic headlamp dimmers, and photoelectric cell circuits. The unit is voltage operated and will operate on currents as low as 8 ma.

Write company direct for a copy of this bulletin.

**TEST EQUIPMENT FLYER**

*Moss Electronic Distributing Co.*, Inc., 3849 Tenth Avenue, New York 34, N. Y. has an eight-page flyer available which lists and pictures an extensive line of test equipment manufactured by *Superior Instruments Company*.

Included is information on v.o.m.'s,

an "Allmeter," tube testers, CRT checkers, a multi-purpose generator, and a service scope. Copies of the flyer are available without charge on request.

**COPPER WIRE TABLES**

The National Bureau of Standards has announced publication of a fourth edition of its "Copper Wire Tables."

These tables are of special importance to workers in the copper industry, electrical engineering, and related fields concerned with the distribution of electrical power.

All data in the book is expressed in both English and metric units. The American Wire Gage as presented in this publication is formed by geometrical progression. The circular also contains a number of simple formulas for computing data for any size wire.

Copies of this publication are obtainable from the Government Printing Office, Washington 25, D. C. Specify NBS Circular 31. Payments of 30 cents in coin for each copy must be included with the order.

**RESISTOR REFERENCE CHART**

A handy, file-size chart giving the essential electrical and mechanical characteristics of its line of variable composition resistors has been prepared by the Electronic Components Division of the *Stackpole Carbon Company*, St. Marys, Pa.

Called "A Quick Guide to Stackpole Variable Resistors," the new chart is printed in two colors on heavy stock suitable for wall, desk-top, or file drawer use. Illustrations and specifications for over 18 basic single- and dual-section controls are shown with a tabulation of all possible modifications available on each control, such as printed wiring or wire-wrap terminals, tab or bracket-mounting devices, line switches, phenolic shafts, etc.

Copies are available on letterhead request to the company.

**GEIGER COUNTER BROCHURE**

A brochure describing its Model 2612L Geiger counter for uranium prospecting is now being offered without charge by *Nuclear Instrument and Chemical Corporation*, 229 West Erie Street, Chicago 10, Illinois.

Full details on the features and operation of the instrument are included in the two-color, four-page bulletin.

**PRINTED CIRCUIT TOLERANCES**

As a service to the industry, the Engineering Department, *Photocircuits Corporation*, Glen Cove, New York has compiled and issued a technical bulletin entitled "Standard Printed Circuit Tolerances."

Included in Technical Bulletin P-9 are such items as diameter tolerances of unplated and plated holes, location tolerances between holes, hole to pattern tolerances, alignment (front to back) tolerances, circuit pattern to outside dimension tolerances, over-all dimension tolerances, holes to outside dimension tolerances, line width and

spacing tolerances, plating tolerances, etc.

The cooperation of electronics manufacturers throughout the country makes this bulletin comprehensive and authoritative.

#### MINIATURE TUBE GUIDE

The eighth edition of its "Reference Guide for Miniature Electron Tubes" is now available from *CBS-Hytron*, Danvers, Mass.

Revised and brought up-to-date, the new edition (Bulletin #PA-1) lists all miniature tubes, irrespective of make. It supplies pertinent data on 416 miniature types of which 88 are new, and 168 basing diagrams of which 33 are new. This 16-page brochure lists prototypes in larger bulbs.

Copies of the new guide can also be obtained from the firm's tube and semiconductor distributors upon request.

#### HYCOR'S COMPONENT LINE

*Hycor*, 12970 Bradley Avenue, Sylmar, California has issued a four-page bulletin which describes its complete and expanded line of precision electrical components for industrial control, guidance, telemetering, and audio equipment.

Bulletin G-3 includes basic specifications for encapsulated precision wirewound resistors, encapsulated toroid coils, miniature magnetic clutches, precision wave filters, telemetering filters, ratio transformers, miniature toroid power transformers, magnetic amplifiers, variable filters, and variable attenuators, among other items.

#### CONCORD CATALOGUE

*Concord Radio*, 45 Warren Street, New York 7, New York has recently issued a 32-page flyer which covers hundreds of items of interest to technicians, audiophiles, experimenters, hobbyists, and hams.

In addition to listing components and surplus bargains, tubes, books, and other items of interest to the electronic industry, the catalogue devotes considerable space to assembled units such as p.a. amplifiers, auto radios, tape recorders, tuners, etc.

For a free copy of this publication, write the distributor direct.

#### EICO EQUIPMENT FLYER

*Electronic Instrument Co., Inc.*, 84 Withers St., Brooklyn 11, New York is currently distributing copies of a handy flyer that lists its complete line of available kits, instruments, and audio equipment.

Included with this pocket-sized folder is a free "pocket-saver" designed to protect the technician's shirt or jacket pocket when used to house small tools, pencils, pens, and rulers.

#### COLOR TV SERVICE BOOK

Publication of a new 92-page illustrated reference book on color television receiver servicing has been announced by the *RCA Service Company, Inc.* of Camden, New Jersey.

July, 1956

# GO URANIUM PROSPECTING on your vacation!

## GET A BRAND NEW RCA GEIGER COUNTER

a HARVEY Exclusive! Limited Quantities—Act Fast!

# at 1/2 Price!

Here they are — in factory-sealed cartons... designed and built by RCA to their world-renowned engineering standards... sold at exactly twice these special prices everywhere outside of HARVEY'S — the same high-sensitivity Geiger counters that have brought wealth to many fortunate and well-equipped uranium prospectors!

3-way radiation detection (by meter, neon light and headphone) • full-vision, easy-to-read meter • three counting ranges • handy zero-reset button • self-contained battery operation (portable radio and flashlight types) • weather-proof metal case (easy to decontaminate in field with damp cloth) • rugged • dependable in any climate

#### Model WF-10A

8"x3 1/2"x7 1/2" alum. case. 5 lbs. incl. batteries.  
Regularly.....\$119.50

**Harvey Special.....\$59.75**

Also available with extra-sensitive bismuth-type Geiger counter tube as Model WF-11A.

Regularly.....\$154.50

**Harvey Special.....\$77.25**

#### Model WF-12A

Has Geiger-counter tube in external probe for exploring fissures and test bores. 7 1/4" x 3 1/2" x 7 1/2" stainless steel case. 5 1/2 lbs. incl. batteries.  
Regularly.....\$149.50

**Harvey Special.....\$74.75**

Also available with extra-sensitive bismuth-type Geiger counter tube in external probe, as Model WF-14A.

Regularly.....\$186.00

**Harvey Special.....\$93.00**

Add estimated shipping charge for total weight, F.O.B., N.Y.C. Excess promptly refunded.



# HARVEY RADIO CO., INC.

Established 1927

103 West 43rd Street, New York 36, N. Y. • JUDSON 2-1500

## TAPE RECORDERS

Tapes—Accessories  
Nationally Advertised Brands  
**UNUSUAL VALUES**

Send for Free Catalog

**DRESSNER**

69-02 RA-174 St.

Flushing 65, N. Y.

#### MERITAPE

Low Cost, High  
Quality Re-  
cording Tape—  
in boxes or  
cans.

## CODE SENDING RECEIVING SPEED

Be a "key" man. Learn how to send and receive messages in code by telegraph and radio. Commerce needs thousands of men for jobs. Good pay, adventure, interesting work. Learn at home quickly through famous Candler System. Qualify for Amateur or Commercial License. Write for FREE BOOK.  
**CANDLER SYSTEM CO.**  
Dept. 2-H, Box 928, Denver 1, Colo., U.S.A.

## GET INTO ELECTRONICS

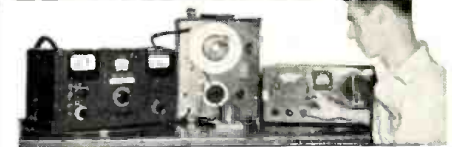

You can enter this uncrowded, interesting field. Defense expansion, new developments demand trained specialists. Study all phases radio & electronics theory and practice; TV; FM; broadcasting; servicing; aviation, marine, police radio. 18-month course. Prepare for good pay. Graduates in demand by major companies. High School or equivalent required. Begin January, March, June, September. Campus life. Write for catalog.

**VALPARAISO TECHNICAL INSTITUTE**  
Dept. RD Valparaiso, Indiana

# DON'T Just say capacitors

Ask For Sprague By Catalog Number

Know what you're getting... get exactly what you want. Don't be vague... insist on Sprague.

Use complete radio-TV service catalog C-610. Write Sprague Products Company,

51 Marshall Street, North Adams, Massachusetts.

# SPRAGUE

WORLD'S LARGEST CAPACITOR MANUFACTURER

## AUDEL'S TV TELLS HOW TO ANSWER RADIO T.V. QUESTIONS SERVICE LIBRARY

HERE IS LATE INFORMATION IN A HANDY FORM FOR TELEVISION AND RADIO REPAIRMEN, SERVICEMEN AND STUDENTS

**AUDEL'S T.V. RADIO SERVICE LIBRARY**—Highly Endorsed—Over 1500 Pages—1048 Illustrations & Diagrams. 1001 Important Facts & Figures on Modern Television, Radio, Electronic Devices at your finger ends.

**INCLUDES TRANSISTORS** & Transistor Circuits, Record Changers, Rectifiers, P.A. Systems, Tape Recorders, Phonograph Pick-ups, F.M., Auto Radio; Radio Compass, Short Wave, Radar, etc.

**ASK TO SEE IT! IT WILL PAY TO KNOW—** The Basic Principles—Construction—Installation—Operation—Repairs—Trouble Shooting. Shows How to get Sharp, Clear T.V. Pictures. Install Aerials—How to Test. Explains Color Systems, Methods of Conversion, Terms, etc. Includes Ultra High Frequency—Valuable for Quick Ready Reference and Home Study.

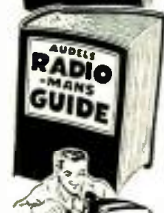

**\$6 COMPLETE**

**2 VOLUMES** Get this information for Yourself.  
**7 DAY TEST—PAY ONLY \$1 A Month**  
**MAIL ORDER**

**AUDEL Publishers, 49 W. 23 St., N.Y. 10, N.Y.**  
Mail AUDEL'S T.V. RADIO SERVICE LIBRARY (2 Volumes) \$6 on 7 days free trial. If O. K. I will remit \$1 in 7 days and \$1 monthly until \$6 is paid. Otherwise I will return them.

Name \_\_\_\_\_  
Address \_\_\_\_\_  
Occupation \_\_\_\_\_  
Employed by \_\_\_\_\_ RN

Entitled "Servicing Color Television Receivers," the new book is designed for reference use by dealers and independent technicians who have attended the many color TV clinics and workshops conducted throughout the country.

The book, which deals specifically with the current *RCA Victor 21CT-660U* series, describes the tools required for efficient color receiver servicing, tells how to use these tools, discusses servicing procedures, etc.

Copies of this book are available from the Commercial Service Section of the company at Camden, N. J. for \$1.00 a copy.

### BUILT-IN RADIO SYSTEM

*Phillips Radio Corporation*, Highway M151, Temperance, Michigan is making available a four-page brochure describing its new built-in radio system for custom installation.

The bulletin is addressed to contractors and architects and describes a master radio system with speaker and four additional room speakers fitted with individual volume controls. The radio and room speaker panels are available in satin stripe chrome, copper, or gold finish.

Write the manufacturer direct for a copy of this brochure.

### NUCLEAR INSTRUMENTATION

A four-page bulletin on nuclear instruments, counter tubes, and voltage regulator tubes is being offered to interested persons by *Anton Electronic Laboratories, Inc.*, 1226 Flushing Ave., Brooklyn 37, New York.

The two-color brochure illustrates and describes the company's ratemeters, survey meters, ore assayers, an instrument for sorting radioactive samples, as well as a line of stainless steel counter tubes, neutron detection tubes, and miniature and subminiature corona discharge voltage regulator tubes.

### ALLIED FLYER

*Allied Radio Corporation*, 100 N. Western Avenue, Chicago 80, Illinois is now offering copies of its new equipment and parts flyer, No. 156.

This 64-page publication pictures and describes hundreds of new items ranging from tape recorders to TV accessories and service gear. A large section on audio equipment and components will be of special interest to the audiophile.

Copies of this new flyer are available without charge. Be sure to specify Catalogue No. 156.

### SILICON POWER RECTIFIERS

*Transitron Electronic Corporation*, Melrose 76, Mass. has issued four new data sheets describing lead-mounted and miniature type silicon rectifiers; transistors, rectifiers, and diodes; and military-type silicon rectifiers (1N253, 1N254, 1N255, and 1N266).

Complete electrical specifications and mechanical data are given for each unit.

# don't be vague...

insist on  
**SPRAGUE**

## TEL-OHMIKE®

CAPACITOR-  
RESISTOR  
ANALYZER



# SPRAGUE

NORTH ADAMS, MASS.



## OSCILLOSCOPE

Model 830  
Mfd. for U.S. NAVY

This scope is a combination of a highly efficient conventional 3" oscillograph, with a thyratron linear sweep and a synchronized sweep frequency modulator or wobulator. Operates from 115VAC-60 cycles. The perfect instrument for service, labs, schools, industry, experimenter. All features of high priced lab scopes available to you at less than the price of a kit.

SIZE: 10" x 7 1/8" x 14"  
wt. 23 lbs.

**\$29.95**

All tested. All in perfect operating condition. All made to rigid Navy specs. A complete scope with instruction book for less than the price of a kit. (We ship by express.)

complete  
F.O.B.  
N. Y.

**CRYSTAL CONTROLLED SUPERHET.** Recvr R-82/ARW-20x. 14 volt dyna. 11 tubes. S meter. \$14.95  
xtal. 8 x 9 x 11—new

### COMMAND SERIES IN STOCK

Revs. All Excellent Condition. All with tubes and crystals.  
3-6 Mc.—w/dyn. Black Wrinkle Finish.....\$6.95  
6-9 Mc.—w/dyn. Black Wrinkle Finish..... 6.95  
XMTRS. ALL EXCELLENT COND. ALL WITH TUBES.  
2.1-3 Mc. Black Wrinkle Finish.....\$5.95  
3-4 Mc. Black Wrinkle Finish..... 6.95  
4-5.3 Mc. Black Wrinkle Finish..... 5.95

5.3-7 Mc. Black Wrinkle Finish.....**\$6.95**  
S.S.B. These Brand New

7-8.1 Mc .....\$6.95  
T-23, 100-156 Mc. Less Tubes, Fair Condition... 4.95  
R-28, 100-156 Mc. with Tubes, Good Receiver... 9.95

### SPECIAL

BC-458, 5.4-7 Mc transmitter, used condition. Perfect for conversion to SSB at an **2 for \$5.00** all time low.....

**MODULATION XFORMER**, 20 watt. Mfd. for TCS transceiver. Stancor 95A10. Also used as 1:1 Isolation.....\$1.95  
**FILA XFORMER**, 24v, 1.5A, Compact FB all surplus gear..... 1.95  
**FILA XFORMER**, 3v, 1.5A, new..... 2.95  
**TUBE TYPE 1625** (SSB types)—Dozen..... 2.25  
**SENSITIVE MICRO-AMMETER**—O-50 Micro Amp DC 2 1/2"—Hermetic Seal—JAN Type—Brand New..... 5.95  
**DUMONT OSCILLOSCOPE 224A**—Exc. Cond 79.95  
**NATIONAL TRANSMITTING VARIABLE COND.** 50MFD-3KV with couplings and vernier..... 1.95

**REX RADIO SUPPLY** 88 Cortlandt St. New York 7, N. Y.

RADIO & TELEVISION NEWS

**Portable TV**  
(Continued from page 37)

Still another circuit innovation used in the RCA set is shown in Fig. 5. A single 6U8 tube is used in conjunction with three diodes in the limiter, sound i.f. amplifier, ratio detector, audio amplifier, and audio output circuits. The sound i.f. limiting is accomplished by CR<sub>101</sub> with one side positively biased by a portion of the cathode bias from the second i.f. stage. Next, the pentode section of the 6U8 acts as a 4.5 mc. amplifier and drives the ratio detector transformer. Detection is performed by the two crystal diodes, and their output is fed back in the form of the audio signal through capacitor C<sub>110</sub> to the pentode which now serves as an audio amplifier. R<sub>101</sub>, the 33,000 ohm resistor in series with the ratio detector transformer, is the audio amplifier plate load. The signal then goes to the volume control and the output tube. The latter is the triode portion of the 6U8 and employs a specially designed output transformer. Approximately .5 watt can be expected from this audio system, with tone quality sufficient for a small portable set of this type.

In the G-E type "M" receivers the maximum available "B+" is only 135 volts since neither a power transformer nor a voltage-doubler circuit is used. To get the required high voltage and deflection, the horizontal sweep output circuit uses some rather unusual features as shown in Fig. 8. The two horizontal deflection coils are connected in parallel and tapped down on the autotransformer. To eliminate the cathode bias circuit and obtain better linearity with maximum efficiency, the cathode of the output amplifier is connected to a special winding on the flyback transformer.

**Servicing Problems**

Many service technicians fear that the introduction of low-cost, small TV sets will bring the same service charge difficulties as experienced with servicing cheap a.c.-d.c. sets. It is almost certain that service problems with portable TV sets will be no simpler than with the more expensive conventional sets, yet the customer will expect to pay less for equivalent service work simply because the set was cheaper when new. In this respect the customer will have to be made aware of the facts.

As mentioned previously, many of the new portable sets use printed wiring which requires special methods for troubleshooting and repair. In general, printed wiring does not permit any faster or more efficient repair than the older system and estimates as to price and delivery on such sets should take this into account.

Another factor which makes portable TV receivers somewhat difficult to service is their compact construc-



**FIELD TECHNICIANS**

*Broaden the scope of your career with Bendix Radio!*

Get these BIG ADVANTAGES!

- Professional status
- The prestige of representing the leader in its field.
- Top salaries
- Liberal field allowances

If you have 5 or more years of electronics experience, you benefit many ways as a Bendix Radio Field Engineer. You will receive full pay while you go to our company-sponsored school in Baltimore. Then, you will be given a key assignment in the United States or overseas with responsibility of maintaining search and surveillance radar equipment made by Bendix Radio.

Write, call or wire EMPLOYMENT SUPERVISOR Dept. R

**Bendix Radio**

DIVISION OF BENDIX AVIATION CORP  
Towson 4, Maryland  
(Phone Valley 3-2200)

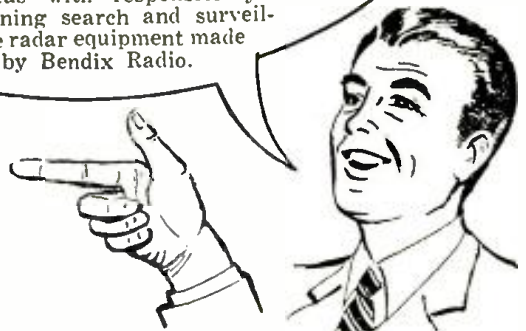

**A.... Always**  
**B.... Buy**  
**C.... Columbia**

**THE BEST-EST BUYS IN BATTERIES!**  
NT-6. Miniature. Wet cell. 6 V. @ \$1.95  
3 amp. Brand new. . . . . 5.37 MC. . . . . \$3.95  
6 V. @ 15 AH: Wet cell. 4 1/4 x 4 1/4 x 6 1/2. Brand new. Special? Only. \$3.95  
WILLARD 25-2: Wet cell. New. . . . . \$2.95  
WILLARD 20-2: Brand new. Hot buy! \$1.95

**SIGNAL CORPS MESSAGE BAG**  
Contains 2-bulb signal light. Brand new package. 3 for \$1.00. EACH. . . . . 39c

**NEW BOXED! COMMAND TRANSMITTERS!**  
2-13 MC. . . . . \$4.95  
4-5.3 MC. . . . . 3.95  
7-9 MC. . . . . 5.95

**CB-307 EXTENSION CORD FOR HEADSET: 95c**  
6 ft. Brand new. 1 for \$2.75. EACH  
**CHAMOIS EAR MUFFS: New. 3 Pk. for \$1.00. PER PAIR. . . . . 39c**

**HEAVY DUTY FRAGET**  
With keeper. 6x8x2 3/4". Out of Magnetrans. New. Ea. . . . . \$4.95

**IT'S TUBE TIME @ COLUMBIA! ALL NEW!**  
2D21 . . . . . \$ .99 70L7 . . . . . \$ .95  
6AG5 . . . . . .50 807W . . . . . 1.99  
6CA . . . . . .50 826 . . . . . .50  
6J6 . . . . . .50 872A . . . . . 1.50  
6VS . . . . . .50 958A . . . . . .49

**5-IN-1 COMBINATION SAW SET: One full-carved handle, 5 saw blades, plastic bag. New. Set. . . . . \$1.25**

**BRAND NEW CO-AX CONNECTORS**  
BARREL TYPE, feed-through, extension connectors. 4 for \$2.80. Each.  
**INFINITE IMPEDANCE CONNECTORS: 4 for only \$1.49. All brand new. Each. 39c**

**BRAND NEW CONDENSERS**  
.5 MFD @ 7,500 V. . . . . \$3.95  
1 MFD @ 4,000 V. . . . . 3.95  
2 MFD @ 2,000 V. . . . . 4.95  
2 MFD @ 3,000 V. . . . . 4.95  
10 MFD @ 600 V. . . . . .89  
10 MFD @ 1,000 V. . . . . 2.95  
15 MFD @ 1,000 V. . . . . 2.95  
15 MFD @ 2,000 V. . . . . 4.95

**TRANSFORMERS & CHOKES SALE-ORAMA!**  
For full line of Xtrms. & Chokes see our June '56 ads in RADIO TV NEWS and C.Q. Magazine! Expect a surprise at the low prices!

**MOBILE POWER SUPPLY. 6 and 12 VDC.**  
Originally used for plate and filament supply for 15-tube FM transmitter-receiver. Fairly small, brand new condition. With cables. Great buy! . . . . . \$4.95

All orders FOB Los Angeles. 25% deposit required. All items subject to prior sale. MINIMUM ORDER \$3.00.  
OPEN FRIDAY NITE TILL 10 P.M.

**ELECTRONICS**  
2251 W. WASHINGTON BLVD.  
LOS ANGELES 18, CALIFORNIA

**SURPLUS RADIO Conversion MANUALS**  
*in two volumes*

Volume 1 Practical conversions. See it at your dealer or send stamp for list of contents.  
Volume 2, Companion to Volume 1.  
**\$2.50 ea.\***

**RADIO HANDBOOK, GIANT 14TH EDITION.**  
A one-volume library of radio information with extensive, simplified theory. Detailed how-to-build-it data on dozens of items of practical radio equipment. . . . . \$7.50\*

**WORLD'S RADIO TUBES (BRANS' VADE MECUM). NEW 12TH EDITION.** Lists over 15,000 tubes from every tube making country. Printed in 16 languages. . . . . \$5.00\*

**BETTER TV RECEPTION (in fringe and low-signal areas). SECOND EDITION.** The standard guide for installation technicians. A popular text for TV enthusiasts. . . . . \$2.50\*

**RADIOTELEPHONE LICENSE MANUAL.** Typical study questions with concise answers for any commercial U.S.A. radiotelephone operator's license . . . . . \$3.75\*

**ANTENNA MANUAL.** A practical comprehensive book on antennas, for everyone interested in transmission and reception. Over 300 pages . . . . . \$3.50

\*Plus any tax Send three cent stamp for circular

**BUY FROM YOUR DISTRIBUTOR**  
Add 10% on direct mail orders to  
**EDITORS and ENGINEERS, Ltd.**  
Summerland 2, California

# BUILD 16 RADIO CIRCUITS AT HOME

With the New Deluxe 1956 Progressive Radio "Edu-Kit" only **\$19.95**

## A PRACTICAL HOME RADIO COURSE

Now Includes **SOLDERING IRON, TESTER, HIGH FIDELITY SIGNAL TRACER, CODE OSCILLATOR, PRINTED CIRCUITRY**



### FREE TOOLS

- No Knowledge of Radio Necessary
- No Additional Parts or Tools Needed
- Excellent Background for TV
- Unconditional Money-Back Guarantee

**FREE** Hi-Fi, Radio & TV Servicing Manuals on Request. (See Coupon Below).

### WHAT THE "EDU-KIT" OFFERS YOU

The "Edu-Kit" offers you an outstanding PRACTICAL HOME RADIO COURSE at a rock-bottom price. You will learn radio theory, construction and servicing. You will learn how to build radios, using regular schematics; how to solder and wire in a professional manner; how to service and trouble-shoot radios. You will learn how to work with punched metal chassis as well as the new Printed Circuit chassis. You will learn the principles of RF and AF amplifiers and oscillators, detectors, rectifiers, test equipment. You will learn and practice code, using the Progressive Code Oscillator. You will build 16 Receiver, Transmitter, Code Oscillator, Signal Tracer and Signal Injector circuits, and learn how to operate them. You will receive an excellent background for TV. In brief, you will receive a basic education in Electronics and Radio, worth many times the small price you pay.

### PROGRESSIVE TEACHING METHOD

The Progressive Radio "Edu-Kit" is the foremost educational radio kit in the world, and is universally accepted as the standard in the field of electronics training. The "Edu-Kit" uses the modern educational principle of "Learn by Doing." You begin by building a simple radio. Gradually, in a progressive manner, and at your own rate, you construct more advanced multi-tube radio circuits, learn more advanced theory and techniques, and do work like a professional radio technician.

### THE KIT FOR EVERYONE

You do not need the slightest background in radio or science. The "Edu-Kit" is used by young and old, schools and clubs, by Armed Forces Personnel and Veterans Aid, for training and rehabilitation. The "Edu-Kit" is used in 79 countries throughout the world. Designed for universal use, the "Edu-Kit" operates on any voltage from 105 to 125 volts, AC and DC. For use in countries employing higher line voltages, a 210-250 Volt AC/DC model is available.

### THE "EDU-KIT" IS COMPLETE

You will receive all parts and instructions necessary to build 16 different radio and electronics circuits, each guaranteed to operate. Our kits contain tubes, tube sockets, variable, electrolytic and paper dielectric condensers, resistors, tie strips, coils, hardware, tubing, punched metal chassis, Instruction Manuals, etc. In addition, you receive Printed Circuit materials, including Printed Circuit chassis, special tube sockets, hardware and instructions. You also receive a useful set of tools, a professional electric soldering iron, and a self-powered, dynamic Radio and Electronics Tester. The "Edu-Kit" also includes Code Instructions and the Progressive Code Oscillator. You will also receive lessons for servicing with the Progressive Signal Tracer and the Progressive Signal Tracer, a High Fidelity Guide, FCC Amateur License Training Book, and a Quiz Book.

All parts, components, etc. of the "Edu-Kit" are 100% unconditionally guaranteed, brand new, carefully selected, tested and matched. Everything is yours to keep. The complete price of this practical home radio and Electronics course is only \$19.95.

### TROUBLE-SHOOTING LESSONS

You will learn to trouble-shoot and service radios, using the professional Signal Tracer, the unique Signal Injector, and the dynamic Radio and Electronics Tester. Our Consultation Service will help you with any technical problems.

J. Stasaltis, of 25 Poplar Pl., Waterbury, Conn., writes: "I have repaired several sets for my friends, and made money. The "Edu-Kit" paid for itself. I was ready to spend \$240 for a course, but I found your ad and sent for your kit."

### FREE EXTRAS

- Radio and Electronics Tester
- Electric Soldering Iron
- Set of Tools
- Tester Instruction Book
- Hi-Fi Book
- TV Book
- Quiz Book
- Membership in Radio-TV Club
- Consultation Service
- FCC Amateur Lic. Training
- Printed Circuitry

**ORDER FROM AD—RECEIVE FREE BONUS RESISTOR KIT WORTH \$5**

**UNCONDITIONAL MONEY-BACK GUARANTEE**  
 "Edu-Kit" Postpaid. Enclose full payment of \$19.95.  
 "Edu-Kit" C.O.D. I will pay \$19.95 plus postage.  
 Send me FREE additional information describing "Edu-Kit." Include FREE Hi-Fi, Radio & TV Servicing Manuals. No obligation.  
 (Outside U.S.A.—No C.O.D.'s. Send check on U.S. bank or international M.O. "Edu-Kit" \$19.95-125 V. AC/DC \$20.95; 210-250 V. AC/DC \$23.45.)

Name .....  
 Address .....

**PROGRESSIVE "EDU-KITS" INC.**  
 497 Union Ave., Room 55E, Brooklyn 11, N. Y.

tion. For example, consider Fig. 9, which shows the two vertical chassis of the 8-inch RCA sets. These two vertical chassis or "decks" are bolted together and in order to perform any troubleshooting or repair the whole assembly must be taken apart first. To complicate matters, there are no easily accessible alignment or test points.

Alignment of these small receivers should be simple since few tuned circuits are used, but regeneration is possible because of the relatively high "Q" of the individual coils and the close proximity of the entire assembly. For this reason, the prescribed alignment frequencies must be observed accurately. To complicate matters, in many sets the alignment points are hard to get at unless the unit is disassembled.

One custom which has already become popular in the case of smaller table model radio receivers is the tendency of economy-minded customers to bring the set to the service shop for repairs. If this custom is extended to portable TV sets, service charges can be kept low.

Since most of these sets will be in primary reception areas, using an indoor antenna, local signal conditions

in the immediate area may noticeably affect reception. In some instances, the service technician may have to take the set back to the customer's home to try it out and determine the trouble spot, especially if the set seems to perform well in the shop. In this connection it is well to look for aluminum blinds or awnings which, when raised, will not interfere with reception but when lowered can seriously reduce the available signal. Such instances have been observed by the author in otherwise excellent reception areas.

It may appear from the preceding that the new portable TV receivers portend additional trouble for the already harassed service operator. The introduction of these new models can also be considered in a more optimistic light. For one thing they will increase business since most of these sets will go to families already owning a TV receiver. Thus the service technician can expect to get more frequent calls from his regular customers. Another bright spot in the picture is that there may be a decrease in the urgent repair calls if there is more than one TV set in the home. This will lessen some of the pressure of the detested "hurry up" jobs.

-50-

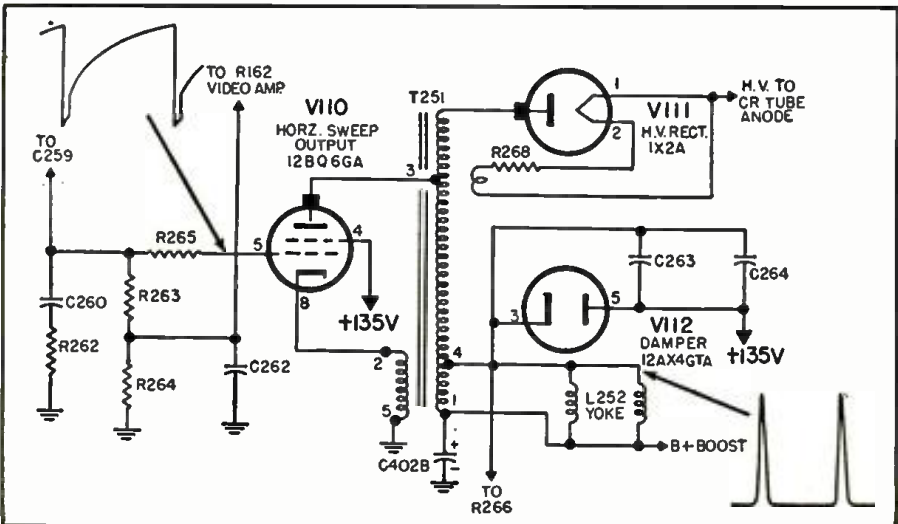
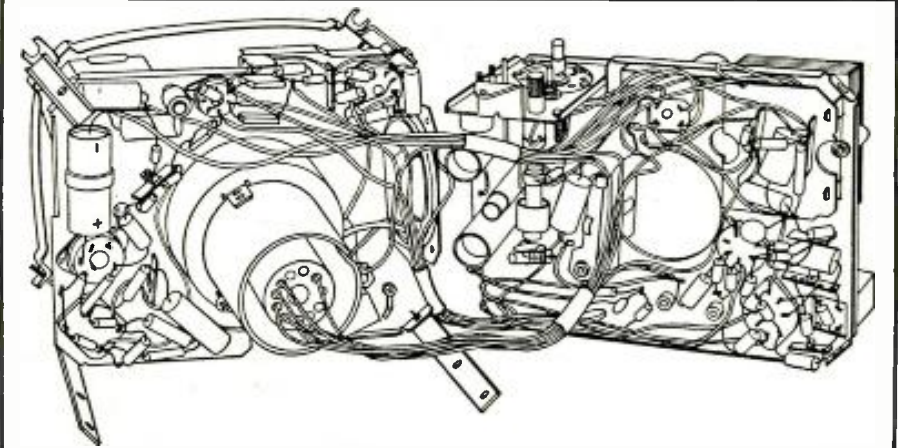

Fig. 8. High voltage section of the General-Electric model "M" receivers. The required 2nd anode and sweep voltages are obtained by using an autotransformer.

Fig. 9. The two vertical decks of the RCA portable TV chassis are shown here.





FIRST



QUALITY

# DIAMOND STYLUS

## ANY TANDEM

(Incl. New GE Clip-in Type)

DIAMOND and SAPPHIRE  
Jobber Boxed Only **\$14.75**

SINGLE DIAMOND  
Jobber Boxed Only **\$13.75**

One Year Manufacturer's  
Warranty on All Diamonds

### ★ ★ ★ ★ SPECIAL ★ ★ ★ ★ GE RPX-052 GOLDEN TREASURE

Diamond and Sapphire Stylus  
Jobber Boxed Only **\$17.95**

Limited Quantity  
All Shipments Prepaid

### COMPLETE LINE of HI FI UNITS WRITE TODAY

## SOUNDMART, Unlimited

63-03 39th Avenue, Woodside 77, N. Y.

Retail Store: AUDIO, Unlimited  
169 W. 57 St. (Opposite Carnegie Hall)

## GET MORE WORK OUT OF YOUR OSCILLOSCOPE

Learn to service  
ANY radio or TV  
faster!



Here, in a brand new 2nd edition, is THE book that really shows you how to use oscilloscopes!

Clearly as A-B-C, MODERN OSCILLOSCOPES AND THEIR USES tells you exactly when, where and how. You learn to locate either AM or FM radio or television troubles in a jiffy. Even tough realignment jobs are made easy. No involved mathematics! Every detail is clearly explained—from making connections to adjusting circuit components and setting the oscilloscope controls. And you learn to analyze patterns fast and RIGHT!

### NEW 2nd EDITION!

Includes Color TV 'Scope Data

Includes latest data on use of 'scopes in color TV, industrial electronics, teaching . . . even in atomic energy work. Over 400 pages and over 400 clear pictures. Dozens of pattern photos make things doubly clear.

### PRACTICE 10 DAYS FREE!

Dept. RN-76, RINEHART & CO., Inc.  
232 Madison Ave., New York 16, N. Y.

Send new, 2nd edition of MODERN OSCILLOSCOPES AND THEIR USES for 10-day examination. If I like book, I will then send \$6.50 (plus postage) in full payment, or return book postpaid and owe you nothing.

Name .....

Address .....

City, Zone, State .....

Outside U.S.A.—Price \$7.00, cash with order only.  
Money back if you return book in 10 days. . . . .

## Mac's Service Shop

(Continued from page 71)

the air and feed it into a dummy antenna. With the mike in front of a radio playing music, I listen to the signal on earphones plugged into my communications receiver working with no antenna. Sure enough I hear the distortion myself.

"Now I use the earphones in series with a blocking capacitor to signal-trace the musical signal through the speech channels. I find it undistorted at the plate of the first tube and the grid of the second, but the distortion is immediately apparent at the plate of the second tube. Checking voltages on this tube with the v.o.m. shows the grid is several volts positive instead of being at zero potential with respect to ground, as it should be. This points the finger of suspicion at the coupling capacitor. When it is unsoldered from the grid there is still a positive potential on the free end. It is leaky and is feeding through the positive voltage on the plate of the first tube. I replace the capacitor and listen to the signal again. The distortion is gone."

"A real snappy story," Mac commented; "but why didn't you include anything about safety measures which must be observed when working on ham transmitters?"

"Because that was handled by another talk at the same meeting," Barney promptly explained. "Any other questions?"

"None," Mac said with a grin. "Let's go to work."  
-30-

A study in contrasts. The tiny RCA Victor "Transistor Six," which weighs approximately a pound with batteries is the modern successor to the company's 1925 "Radiola 24," the 57-pound "portable" of its day. The "Radiola" model was the first of the luggage-type superheterodyne portables and, for its time, was a marvel of compactness and convenience. Thirty years later, however, thanks to miniaturization and the development of transistors, the portable user has a truly "pocket radio."



## The Best Way to Play

## Your Records\*

is on a

## TURNTABLE

## The Best Turntable

## You Can Buy

is a



THE

PRESTO T-18

*Pirouette*

Professional performance standards combined with maximum simplicity of use. Beautifully machined cast aluminum turntable and accurate, heavy-duty 4-pole motor for super-smooth, rumble-free operation. Three-idler drive system with interchangeable idler wheels. Single-flick shift, operated in one plane, selects 33 1/3, 45 or 78.26 rpm speeds and shuts off motor. **\$66.00**  
\*especially long-playing records

PRESTO RECORDING CORPORATION  
PARAMUS, NEW JERSEY



**EXCLUSIVE!!**  
**3 TRANSISTOR RADIO KITS**  
by "KIT KING"

**\*DUAL POWERED, SUN POWERED OR CELL**

**KIT #1 "SOLAR/CELL."** Dual-powered, pocket size unit, sensitive with ample volume. Sun Battery for daylite (works on 110W lamp, too), Mercury Cell for nite operation outlasts regular batteries five times! Pre-drilled plastic cabinet. Step by step instructions: hi-gain transistor, diode, bypassed, variable condenser, socket, phone jacks, switch, wire, knob, hardware. Wt. 6 oz. **\$7.88**  
**COMPLETE**

**KIT #2 "SOLAR."** Sun battery powered. (Kit #1 less mercury cell & switch). Wt. 5 oz. **\$6.88**

**KIT #3 "CELL."** Mercury cell powered. (Kit #1 less sun battery). Wt. 5 oz. **\$5.55**

**HI IMPEDANCE PHONES** for above sets, only **\$1.95**  **SOLDERING IRON** with solder included, only **\$1**

**FREE! ANY \$1 KIT WITH EACH \$10 ORDER!**  
**FAMOUS "KIT KING" \$1 KITS**

- 8-PC. NUTDRIVER KIT.** Plastic handle; 3/16, 7/32, 1/4, 5/16, 11/32, 3/8, 7/16" steel socket wrenches in plastic case. Wt. 1 1/2 lb. **\$3.50 value. \$1**
- 60 MICA CONDENSERS.** Postage stamp types, 25 values; .00001 to .01 mf to 1200 WYDC. Silver. 5% tool. Wt. 1/2 lb. **Reg. \$1 \$21.**
- 60 CARBON RESISTORS.** Insulated, 35 values; 15 ohms to 10 meg; 1/4, 1 & 2 w. 1 & 5%. tool. Wt. 1/2 lb. **\$1**
- 40 MOLDED CONDENSERS.** Best known make! Ass'd. values, .0005 to 0.1 mf up to 1000V. Wt. 1/2 lb. **Reg. \$1 \$13.**
- 25 TUBE SOCKETS.** Subminiature, 7, 9-pin, 4 to 8-pins. Mica-filled and ceramic. Some shielded base. Wt. 1 lb. **Reg. \$9. \$1**
- 50 CERAMIC CONDENSERS.** Disc, tubular, cartwheel, standoff types. 3 mmf to .01 mf up to 1000V. Silver. 5% tool. Wt. 1/2 lb. **\$1**
- 30 DISC CONDENSERS.** Ceramic, .47 mmf to .01 mf, up to 1000V. Assorted values. **Reg. \$1 \$12.**
- 50 RF COILS & CHOKES.** 20 types RF coils, chokes & slug-tuned coils for radio, TV lab. **\$1**
- 60 TUBULAR CONDENSERS.** 25 values; .00035 to 1 mf up to 6000V. Oil, tool. Wt. 2 lbs. **Reg. \$1 \$10.**
- DIODE KIT #1.** Four of the most used types: 1N21, 1N22, 1N23, 1N34A. Shop, lab must! **Reg. \$1 \$11.**
- DIODE KIT #2.** Three popular diodes in poly bag: 1N34, 1N48, 1N51. **\$1**
- 2000 PCS. HARDWARE.** Woodworking, radio-TV, shop screws, springs, grommets, etc. Hundreds of items. Wt. 2 1/2 lbs. **\$1**
- 60 TERMINAL STRIPS.** Ass'd. solder terminal strips & clips: 1 to 7 lugs. **Reg. \$4. Wt. \$1 1/2 lb.**
- 7 ROLLS HOOKUP WIRE.** Seven, 25-ft. rolls #18 to #24. Ass'd. stranding, insulation colors. Wt. 1 1/2 lb. **Reg. \$1 \$4.**
- 12 AC-DC LINE CORDS** for all electrical equipment. 14" long w/ molded plugs. Stock up now! **\$1**
- 125 RESISTORS.** Insulated and non-insulated, 35 values, 50 ohms to 1 meg; 1/4, 1 & 2W. A.B. & 5%. tool. Wt. 1/2 lb. **\$1**
- CRYSTAL RADIO KIT—** lowest price anywhere! Complete with 1N34 diode, loopstick, cabinet, condenser, wire, hardware. In 64 instructions. **Reg. \$2.50. \$1**
- 15 VARIABLE CONDENSERS.** Ceramic T-S2A types, 10 values. Single and duals. Wt. 1/2 lb. **Reg. \$1 \$12.**
- 15 VOLUME CONTROLS.** Ass'd. values to 1/2 meg. Wt. 1/2 lb. **Reg. \$1 \$12.**
- 150 PARTS!** Large assortment, resistors, discs, tubulars, chokes, fuses, slugs, wire, etc. A rare buy! **\$1**
- 20 W.W. POWER RESISTORS.** 20 values to 20,000 ohms. Tubular, candohm, sanded. **\$1**
- POWER SUPPLY SET.** Includes transformer: 115 to 6.3V @ 0.6A; 150V to 1.5V. Ass'd. parts, rect. 65 ma. Wt. 3 lbs. **Reg. \$1 \$4.50.**
- 12 PANEL SWITCHES.** 8 types—micro, A.C. car. push, rotary. **Reg. \$1 \$12. Wt. 2 lbs.**
- 7 PANEL LIGHTS** for miniature bayonet bulbs. Enclosed add 100 ohm resistors. Panel Mtg. **Wt. \$1 1/2 lb. Reg. \$5.**
- 10 "POLY" BOXES.** Ass'd. sizes, hinged & snap lock clear plastic boxes, for pocket radios, etc. Hundreds of uses. **Reg. \$1 \$2.50.**
- SCOOP! 40 SUBMINIATURE RESISTORS.** Size: 7/64" x 1/16" 50 ohms to 1.5 meg. 1/2 values. Plastic cased, 1 & 5%. **\$1**
- 20 PRECISION RESISTORS.** Ass'd. to 100 megs. Carbo-film, tool! Well known maker, with production leads. Wt. 1/2 lb. **\$1**
- 20 Instrument KNOBS.** Knurled, skirted, precision instrument and equipment types; 10 styles, brass insert w/set screws. **\$1**
- 15 CERAMIC TRIMMERS.** Erie TS2A type, 10 values; singles & duals. **Reg. \$12. Wt. 1/2 lb. \$1**

**FREE! GIANT BARGAIN FLYER!**

**HOW TO ORDER** Check items wanted. Return entire ad with check or MO. Include sufficient postage, excess returned. C.O.D. orders, 25% down. Rated, net 30 days.

Name ..... (please Print)  
Street .....  
City ..... Zone ..... State .....  
Enclosed \$..... for items; \$..... for postage.

**LEKTRON SPECIALTIES**

28 GARDNER ST. CHELSEA 50, MASS.  
Visit our salesroom at 131 Everett Ave., Chelsea

# RADIO-TV Service Industry News

**AS REPORTED BY THE TELEVISION TECHNICIANS LECTURE BUREAU**

"IF YOU have a thing to sell Don't go wishin' down a well; Take your ego by the collar Jump upon a roof and holler." Whoever wrote that rhythmic bit of sage advice must have been looking at men who run radio and television service businesses when the inspiration struck him.

Not long ago your editor dropped in to see a man who owns a very successful service business. It is a well balanced business that handles auto radio service as well as that on television and radio sets. An attractive retail department was sectionalized for displaying a wide range of TV and major appliances with a well stocked traffic appliance corner. Actually, it is a well-rounded service center for the community it serves because it provides service on traffic appliances and almost any other type of device that plugs into a power-line socket.

Asked how business was, the owner said, "Not so good lately. Volume has been down." Then after a fast review of the situation, he proceeded to explain what was wrong with him and practically every other man he knew in the service business.

"We are chumps the way we fail to promote our businesses," he said. "We do not look ahead and plan for these seasonal let-downs in TV service. When they come, they come fast. Income takes a nosedive and we start scurrying around for a promotion that will quickly build volume on something else.

"It takes from one month to two months," he continued, "to plan a promotion, and to get the stuff printed and in front of the public long enough for it to bring in business. I should have started to promote something else two months ago to offset the drop in TV service that always comes along this time of the year."

He discussed his failure to consistently promote his auto radio service department. Prior to TV, he had had an excellent business on auto radios but under the pressure of keeping up with TV service, he had let his promotion programs on auto radio service die off. Now he is in the process of working up a long range campaign on this phase of his business to build it to the level where it should be.

"Then there is industrial and commercial sound equipment," he said, "that no one promotes. One of the large stores in town asked me to make a thorough check of its store-wide intercom and call equipment, make an entirely new installation, if necessary, and then take over its maintenance. The store wanted to drop its plan of internal maintenance because it was not satisfactory. I let it slide because we were swamped with TV service at the time. Yet it is a far more stable business than consumer TV service.

"There are hundreds of commercial and industrial establishments and small offices that would buy some kind of sound equipment," he continued, "if some of us would take the time to sell it to them and install it. Yet we all sit around griping because the service business is lousy."

**Pump Priming**

The fuel that powers any business, from the smallest service shop to the largest corporation, has a triple name—selling, advertising, and promotion. Good salesmanship in a service business is the way service customers are handled in every contact. A pleasant response over the telephone when a customer calls for service creates confidence. A friendly smile, simple explanations of what caused the trouble, and a wholesome interest in people will help you keep customers as regulars after they call you the first time.

The appearance of your service car and your shop, and your ads in the phone book and in daily or community newspapers all enter into the effectiveness of the way you advertise your business.

The third ingredient in this business fuel is labeled promotion. A service special to bring in business during a seasonal lull is termed a promotion. However, when you cook up a service special you must have some way of letting set owners know about it. If you had a fancy budget to spend, you could run some big newspaper ads about it. However, the profits from service are not adequate to support newspaper ad campaigns, so you must find a less expensive way to get word to prospective customers.

Small shops have found that direct mail and house-to-house distribution of literature is both the most economical and most effective way to get results. If you do not have mailing lists, the chances are good that a professional mailing concern in your town can provide you with a list of home owners in any area that you may want to cover. These companies will address and mail the material for you. The plan used by most service shops who have literature distributed house-to-house is to employ high school boys and girls for this work.

Radio service is the best source of summertime business for the average small shop. Many people break their regular TV viewing habits during the summer months and use their radios more. Consequently, they are more conscious of the defects that have developed in their radio sets.

An effective promotion, if it is intensively exploited, is to offer a "super-special" on 5-tube a.c./d.c. table model radios for a limited period of time. The "special" could be to offer to service any make of 5-tube table model radio for a limited period of time for \$1.50 labor plus tubes and parts. One shop that exploited this special during August last year was swamped with radio service business for several months. This man planned his "August Special" early in July. He prepared copy for four handbills to be distributed, one per week, in the area he selected for this intensive promotion. Arrangements were made with a couple of high school age boys to take care of the distribution to about two thousand homes.

Distribution of the handbills started on the first day of August. Using a cross reference telephone directory, each day the shop owner's wife telephoned about twenty-five people in the area where handbills had been distributed the day before, to inquire whether they had received the handbills and if they had any radio sets to be repaired on this summertime special plan. By the middle of the second week of August, they had to add another technician to help handle the flood of radio sets that came in. This promotion not only provided a healthy profit during August but it also put this shop owner wise to a source of service business that has been badly neglected. This was the work available in repairing console radios.

Almost every home has a console with a radio-phonograph combination. Although the television set is the focal point for family entertainment, there is an interest in keeping the radio console in good repair since there is little interest in buying a new one. This is a good type of business for a shop to handle because there is no rush to have the set serviced and back on the job. It is the kind of work in which the customer will cooperate so it can be handled during the periods when TV service is off.

Another shop owner who put on an

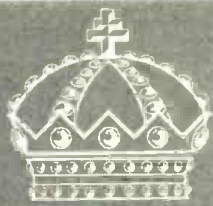

**GUARANTEED  
PERFORMANCE**

# CROWN

## Professional Tape Recorder

# CROWN PRINCE

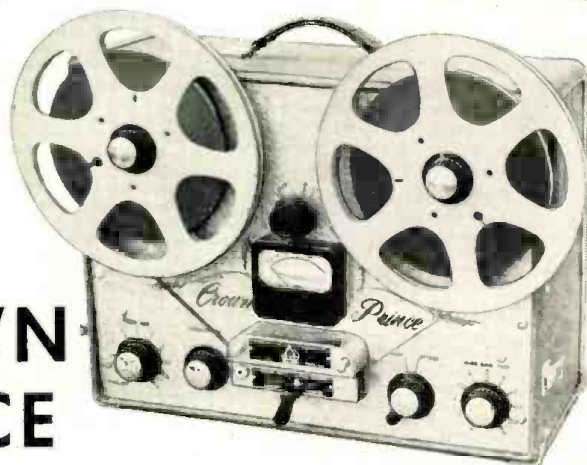

**Easily Portable. 10 1/2" Reels. Rack mounting tape transport.**

### IDEAL FOR HI-FI INSTALLATIONS!

IPS	DUAL TRACK		Flutter WOW	Noise Ratio
	Frequency Response Record and Playback	CPS		
15	±2 DB 20-18000	CPS	.10%	55 DB
7 3/4	±2 DB 20-15000	CPS	.15%	52 DB
3 3/4	±3 DB 40-8000	CPS	.25%	44 DB

Less Case **\$349<sup>50</sup>**

Write for literature.  
Address Dept. RN-7

*Specifications . . .* "MICRO-LINEAR" HEADS • THREE SPEEDS • THREE MOTORS • MEETS NARTB STANDARDS • "MICRO-SYNC" TIMING • STRAIGHT LINE THREADING • 4" DUAL LIGHTED METER • MAGNETISM BRAKING • PERFECT ERASURE • CATHODE FOLLOWER OUTPUT

**INTERNATIONAL RADIO & ELECTRONICS CORP.**  
ELKHART, INDIANA

**MUST MOVE OUR WAREHOUSE**

**Set Builders—Experimenters**

**GIANT SURPRISE KIT \$4<sup>95</sup>**

25-30 lbs. of brand new RADIO PARTS . . . no junk . . . Transformers, Filter and Bypass Condensers, Resistors, Wirewound, Carbon, Volume Controls, Sockets, Wire, Variables, Chassis and Gang Switches. Parts that every Service Man, Experimenter or Ham needs. Express or Freight Shipments Only. No C.O.D.

**NEWARK SURPLUS MATERIALS CO.**  
324 PLANE ST., Newark, N. J.

**a TERRIFIC BARGAIN in a**

**SOLA CONSTANT-VOLTAGE TRANSFORMER**  
Ends fluctuating line voltage!



**OVER 60% OFF...**

the factory price at a 1-input 2,000 VA unit! And here's another bonus! This Air Forces 2,000 VA overstock, Sola Cat. No. 30768, has 4 inputs! 50-125 V., 190-250 V., 60 cy. or 50 cy. Isolated secondary is constant 115.0 V. ±1% from no-load to full-load of 17.4 amp. So, if you choose, use it as a 220:115 V. step-down. And slash \$147.50 off the factory 1-input price!

Brand new in original wood box, 4 cu. ft. Ship. wt. 25.4 lbs. F.O.B. **\$97.50**  
Pasco, Wash. Only  
**THE M. R. COMPANY**  
P. O. Box 1220-A Beverly Hills, Calif.

# AMATEUR CRYSTAL Headquarters

## CRYSTAL HOLDER DATA

FT-243 and FT-241-A holders have 1/2" pin spacing (2 of either of these crystals will plug into any standard octal tube socket). DC-34 holders have 3/4" pin spacing-sockets available when ordered with crystals, each at **25¢**

## NOVICEBAND

80 meters within 1 kc of specified frequency—3701 to 3749 kc in DC-34 or FT-243 holders—(specify holder wanted) **79¢**

## 40 METERS

From 7152 to 7198 kc within 1 kc of specified frequency in FT-243 holders only **79¢**

2—6—10—15—20—40—80 Meter Ham Bands in DC-34 or FT-243 holders (specify holder wanted) **79¢**

## STOCK CRYSTALS

Send postcard for free list of frequencies. FT-241, DC-34, FT-243, FT-171, each **50¢**

## SPECIAL CRYSTALS

Crystals ground and etched to exact frequency, using electronic counter, in FT-243 holders with 1/2" pin spacing. From 3000 kc to 9000 kc.

.05% tolerance \$1.35 ea. .01% tolerance \$1.50 ea.  
.005% tolerance \$2.50 ea.

Crystals ground and etched to exact frequencies in DC-34 holders with 3/4" pin spacing. From 1691 kc to 4600 kc.

.05% tolerance \$1.35 ea. .01% tolerance \$1.50 ea.  
.005% tolerance \$2.50 ea.

## STOCK CRYSTALS

In FT-243 holders—5675 kc to 8650 kc in 25 kc steps each, **50¢**

## FT-241 LATTICE CRYSTALS

In all frequencies from 370 kc to 540 kc—**50¢**  
500 kc Crystals—**\$1.00** 455 kc Crystals—**\$1.00**

# Texas Crystals

The Biggest Buy in the U.S.

8538 W. GRAND AVENUE · RIVER GROVE, ILL.  
ALL PHONES — GLADSTONE 3-3555

Terms: All items subject to prior sale and change of price without notice. All crystal orders MUST be accompanied by check, cash or M.O. WITH PAYMENT IN FULL. NO C.O.D.s. Postpaid shipments made in U.S. and possessions only. Add 5¢ per crystal for postage and handling charge.

August a.c./d.c. table model radio service special used a pick-up and delivery offer to get action. When telephoning after the handbills had been distributed, the offer was made that if they could pick up the set or sets that afternoon, pick-up and delivery would be made without charge. Through careful planning, the telephone canvass was focused on a concentrated area each day so a load of radios could be picked up with minimum travel.

The impending political conventions provide an opportunity to build summertime service volume. When the conventions get underway everyone who owns a TV set will want to watch the big show. There will be a sharp upsurge in the volume of TV service calls.

Alert shop owners will take advantage of the up-coming conventions to sell service during July and August in anticipation of the big events. A good "gimmick" for selling service during July and August is to offer customers a plan of extended payments without interest to pay for jobs that amount to twenty-five dollars or more. Obviously, arrangements should be made for adequate credit checks on customers who want to take advantage of the plan.

## Promotions that Build

All types of businesses find it necessary to dream up special promotions to prime the business pump during seasonal lulls. But these are "fill-ins" that in no way minimize the necessity for steady, consistent promotion of the business the year around.

Figures recently released by the U.S. Bureau of Census show that 17% of the population move to new or different homes every year. That means that 17 out of every 100 of your regular customers will move out of your area this year and they will be replaced by 17 new families who never heard of you before. You must keep pounding away to make your business known to the new families that come into your operating area.

Surveys show that the average one-man shop takes in less than eight hundred dollars per month for service and sales. Obviously, when all of the operating expenses are paid, and the technician takes his own salary out of the business, there is not a great deal of money left to pay for promotions.

All of the receiving tube manufacturers provide professionally prepared promotional material that is so low in cost that even the smallest service business can afford all of the things needed for a well-rounded, consistent promotional program. A standard package of material for a small shop should include the following:

1. Imprinted letterheads, billheads, envelopes, and business cards
2. Imprinted stickers to be placed on the back of each set repaired
3. Imprinted "Good," "Fair," and "Bad" tube stickers to be attached to each tube tested

# CONALERT MONITORS CONELRAD



- Fail-Safe
- Meets FCC Requirements
- 5 Channels
- FCDA Approved
- Low Cost
- Effective as of Jan. 2nd, 1957—

## MANDATORY FOR OPERATORS OF ALL RADIO TRANSMITTERS!



For complete information write:  
**ENGINEERING CORP.**  
2981 Middlefield Road  
Palo Alto, California

## Latest HICKOK Tube Tester Roll-Chart

To keep your HICKOK Tube Tester up to date, HICKOK reprints new roll-charts every 6 months. Easy to install. Send \$1... Be sure to specify model number of your HICKOK Tube Tester.

THE HICKOK ELECTRICAL INSTRUMENT COMPANY  
10524 Dupont Ave. • Cleveland 8, Ohio

## RADIO and TELEVISION ELECTRONICS



in all Technical Phases  
New Classes (Day and  
Evening) Start 1st of  
Dec., Mar., June, Sept.

Free Placement Service for Graduates  
For Free Catalog write Dept. RN56

RCA INSTITUTES, INC.

A Service of Radio Corporation of America  
350 WEST 4TH ST., NEW YORK 14, N. Y.

## PM SPEAKERS (ALNICO #5)

Brand New Factory Guaranteed Stock

1 oz. mag. on 3" to 6", heavier mag. on 8" to 12"	
3" .....	\$ .98   6" .....
4" .....	1.17   8" .....
5" .....	1.29   12" .....

## SELENIUM RECTIFIERS

75 ma. \$ .49	150 ma. \$ .74	300 ma \$ 1.19
100 ma. .62	250 ma. 1.08	500 ma 1.42

CAPITAL ELECTRONICS, 222 Fulton St., N. Y. C.

## MUST HAVE FOR CURRENT ORDERS PHONE COLLECT

BC-312	BC-314	BC-610
BC-342	BC-344	T-47/ART-13
R-5/ARN-7	ARC-3	ATC/ART-13

SEMLER INDUSTRIES INC. Stanley 7-1554  
6853 Lankershim Blvd. North Hollywood, Calif.

## ENGINEERING



Prepare for unlimited opportunities of the Electronic Age! Earn your B.S. degree in 27 months at Indiana Technical College. Intensive, specialized course. Comprehensive training in math and electrical engineering, advanced radio theory and design, television, electronics, Modern laboratories. Low rate. Also B.S. DEGREE IN 27 MONTHS in Aeronautical, Chemical, Civil, Electrical and Mechanical Engineering. G.I. approved. Enter September, December, March, June. Earn part of your expenses in Fort Wayne while studying. Write for catalog.

## INDIANA TECHNICAL COLLEGE

976 E. Washington Blvd., Fort Wayne 2, Indiana  
Please send me free information on B.S. ENGINEERING DEGREE IN 27 MONTHS as checked.

- |                                      |                                     |                                       |
|--------------------------------------|-------------------------------------|---------------------------------------|
| <input type="checkbox"/> Electronics | <input type="checkbox"/> Chemical   | <input type="checkbox"/> Aeronautical |
| <input type="checkbox"/> Civil       | <input type="checkbox"/> Mechanical | <input type="checkbox"/> Electrical   |

Name .....  
Address .....

RADIO & TELEVISION NEWS

4. Imprinted service order forms
5. Postcard mailers
6. Rubber stamp with shop name, address, and telephone number
7. A series of service selling ad mats

Decals for the service car and shop, an illuminated shop sign, window cards and display streamers, etc., should all be tied into the same theme and color scheme.

A substantial supply of all of these elements that are important in a coordinated promotion program can be obtained from any of the tube manufacturers through local parts distributors. By using the tube company's promotional materials, a small shop can get all of the material needed to keep in touch with a thousand home owners monthly for less than five-hundred dollars per year. The exact cost per shop would be determined by the number of set owners required as customers to provide the gross volume of business necessary to maintain the business and provide a steady growth.

A wide variety of promotion plans have been developed by service technicians to suit the individual requirements of their businesses and fitted to the communities in which they are located. Direct mail has proven to be the best method for promoting a small business when it is carried out consistently.

Many men buy the imprinted, government stamped postcard mailers from tube companies and, without fail, address and mail twenty-five to fifty of these cards to home owners every day. This staggers the job of addressing so that it is handled in a short time each day.

A list of 600 home owners would represent a potential service volume of slightly more than \$12,000 per year on TV and radio sets. The total cost per month for cards and postage to keep in touch with 600 prospective customers would be about \$36. By addressing about 25 per day regularly, no extra expense is incurred. Yet, each month without fail, each of these 600 set owners will get a little message from you reminding him of the services you can perform and telling him how to get in touch with you.

A decided advantage in direct mail for the small operator is that it can be concentrated in preferential areas and the calls that come from these sections will require a minimum of travel time to complete.

There is not a wired home anywhere that does not have either a radio or TV set or some kind of an appliance that needs service. The business is there—all around you. But you have to promote yourself to get those service jobs.

#### Association News

The Detroit City Council recently passed an ordinance requiring a license to conduct a business for installing and servicing television equipment. To qualify for a license, a

# GRAND OPENING SALE

TO introduce you to our large new home  
4 floors of **QUALITY MERCHANDISE**  
at **ROCK BOTTOM PRICES . . .**



## SPECIAL OPENING BARGAIN COMPLETE TV SET—DESIGNED, ENGINEERED & MANUFACTURED BY TECH-MASTER WITH SYLVANIA ALUMINIZED PICTURE TUBE . . .

DESIGNED FOR  
FRINGE AREA  
OPERATION.

- 6 microvolt sensitivity
  - Automatic gain control
  - Auto-transformer high voltage system
  - Synchronized sound and video
  - 3 stage stagger-tuned IF
  - Heavy duty power transformer
  - 2 stage video amplifier sweep circuit
  - High gain Standard Coil tuner
  - 17 KV high voltage output
  - Automatic brightness control
  - Complete with mounting brackets, Alnico V speaker and knobs.
  - Chassis with Sylvania Aluminized Tube.
- 21" - \$136.95 • 24" - \$147.95 • 27" - \$175.95**  
PICTURE TUBE GUARANTEED 1 YEAR

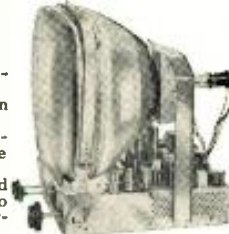

## MASKS 1 piece Lucite for above tubes: Gold border; outside mount

**21" - \$7.95 - 24" - \$14.95 - 27" - \$17.95**

## RECORD CHANGER BARGAINS



- COLLARO RC 456:** New 4 speed manual, automatic, intermix changer; weighted turntable, rubber mat, plug-in head, 4 pole motor. **\$29.95**
- WEBSTER MDL 140:** 3 speed intermix, automatic shut off, dual styli cart. 2 pole motor. Reg. \$37.50. **\$21.95**
- WEBSTER MDL 140 GE:** 3 speed intermix, with GE reluctance RFX 050-A cart., dual sapphire styli, automatic shut off. Reg. \$40. **\$25.95**
- MONARCH MDL U48:** British made, 3 speed, weighted turntable, intermix, automatic stop and shut off, heavy duty 4 pole motor, rubber turntable mat. Reg. \$49.95. **\$22.95**
- GARRARD RC 121:** New, 3 speed, auto-manual changer; heavy duty turntable, 4 pole motor, plug-in head. **\$42.50**
- GARRARD RC 88:** Latest model, 3 speed, deluxe; weighted turntable, mat, automatic shut off, plug in heads. **\$54.50**
- GARRARD RC 98:** 3 speed (variable) super auto-manual changer with 45 RPM adapter spindle. **\$67.50**

All merchandise is brand new, factory fresh & guaranteed. Mail & phone orders filled on receipt of certified check or MO of 20% of items as a deposit. Balance C.O.D., F.O.B. factory N. Y. Prices & specifications subject to change without notice.

**AIREX RADIO CORP.** 64 Cortlandt St., N.Y. 7, N.Y. Phone CO 7-2137

## RECORD CHANGER BASES & BOARDS

- for the changers listed
- BASES . . . \$3.89 MOUNTING BOARDS . . . \$1.95**  
12" Ball Bearing Phono Slides . . . pr. \$1.95
- GENERAL ELECT GOLDEN TREASURE RELUCTANCE CARTRIDGE RFX 052A:** Triple play .003 mill sapphire & .001 mill diamond. Clip-in Stylus. Stylus pressure 6-7 grams. 6-8 grams. **\$22.90**
- RECOTON - GOLD DRING MAGNETIC TURNOVER CART. "500.":** Triple play, .003 mill sapphire & .001 diamond. Response 20-16000 cycles. Stylus pressure 6-7 grams. Mounts in any tone arm with 1/2" hole. 6 centers. **\$22.95**
- RONETTE HI-FI CARTRIDGE:** with dual sapphire styli. For use with any of changers listed. **\$3.95**
- 45 RPM SPINDLES**  
GARRARD . . . \$3.49  
WEBSTER . . . \$2.95  
MONARCH . . . \$2.95  
COLLARO . . . \$2.95

## MULLARD HI-FIDELITY TUBES

Type	Replaces	Description	Price
EL34	KT66; 6CA7	For amplifiers up to 100 watts	<b>\$4.35</b>
EL37	6L6; 5881; KT66	Increases power output 10-25% while reducing distortion level	<b>\$3.50</b>
EL84	6BQ5	2 in push-pull delivers up to 20 w.	<b>\$2.40</b>
ECC81	12AT7	Eliminates microphonics & reduces noise levels.	<b>\$2.60</b>
ECC82	12AU7	Eliminates microphonics & reduces noise levels.	<b>\$2.20</b>
ECC83	12AX7	Eliminates microphonics & reduces noise levels.	<b>\$2.50</b>
EF86	Z729; 6267	Reduces hum, noises & microphonics	<b>\$2.75</b>
QZ32	5V4; 5U4	Delivers currents up to 300 MA. Sep cathode construction	<b>\$2.95</b>



## FM-AM TUNER KIT

Easy to assemble. Professional quality performance. 3 double tuned IF stages. Foster-Seeley discriminator, automatic frequency control & defeat. 7 tubes plus rectifier. Distortion less than 1%. Hum level -70dB. Sensitivity 5 microvolts for 20 dB quieting on FM & 20 microvolts on AM. FM selectivity 200KC band width 8 DB down; AM 5KC band width 5 DB down. 5 1/2" high x 9 1/2" wide x 8" deep. Complete with step-by-step instructions. **\$29.95**  
**FM TUNER ONLY—\$23.95 • COVER—\$3.95**  
These units are ideal in combination with the Grommes Hi-Fi Amplifier.



## Grommes Hi-Fi Amplifier Kit

10 Watts, 18 watts peak. Resp. 20-20,000 cps. 1 db. Presamp. 4 inputs. Hum—80 db. 2% Harm. Dist at 10 watts. Complete with detailed step by step instruction manual, all resistors, condensers, tubes, wire & solder. Easy to make. 2-12AX7, 2-6V6. **\$24.95**  
5Y3, Bass & Treble boost. Limited quantity.

## 5 WATT, 3 TUBE AUDIO AMPLIFIER

ONE & VOLUME CONTROL. With 12AU6; 35Z5; 50L6 & output transformer & extra AC receptacle. Phono jack input. 7 1/2" x 3" with mtg. brackets. **\$6.95**

## Standard Coil Cascode TV Tuner

Replacement for any type TV set. 41 MC. IF. Shaft length 2 3/4". **\$9.95**  
Knobs to match—69c.

## WESTERN ELECTRIC POWER AMPLIFIER

Complete with ruggedized tubes 6S37, 6X57, 6L6—condensers, chokes, resistors. Many uses. Original cartons. From radar equip. Gov't cost \$95. Tubes worth \$7.75. Complete. **\$3.49**

## THE NEW No-Noise TUNER TONIC

Volume Control and Contact Restorer with Perma-Film



Cleans, lubricates, protects not a carbon-tet solution. Still available in the new 6 oz. spray can. Net to servicemen—\$2.25



2 oz. bottle. Net to servicemen **1.00**

Also available in 8 oz. bottles and quart cans. At your nearest distributor.

with PERMA-FILM

Cleans, lubricates, restores all tuners including water type. Won't change or affect capacities, inductance or resistance. Won't harm insulations or precious metals, nor attack plastics. For television, radio and FM. Eliminates all noise, oxidation and dirt indefinitely. Non-toxic. Net to non-indiam. service-men. In-sure trouble-free performance. **\$3.25**  
Extra economical because a small amount does the job!



## ELECTRONIC CHEMICAL CORP.

813 Communipaw Avenue

Jersey City 4, N. J.

# STAN-BURN

## CATHODE RAY TUBE SPECIALS

ONE YEAR GUARANTEE						
G.E.	Type	STAN-BURN	G.E.	Type	STAN-BURN	
\$13.25	10BPA	\$10.20	\$28.15	17CP4	\$19.50	
18.00	10FP4	14.00	31.25	17GP4	20.75	
16.25	12LP4A	13.95	32.25	19AP4A	22.50	
	12QP4	10.50	27.40	20CP4	18.95	
28.95	12UP4	14.50	33.00	21AP4	22.25	
18.15	14CP4	13.40	33.25	21MP4	23.50	
	15DP4	14.40	37.40	21CP4	20.15	
31.25	16AP4A	18.50	90.75	24AP4	49.00	
26.25	16KP4	15.75	<b>DUMONT TUBES</b>			
31.25	16GP4	18.50	12QP4A	23.75	16FP4	26.00
29.00	16LP4	15.25	15DP4	26.55	17KP4	25.00
29.00	16WP4	15.25	16DP4A	31.00	19AP4A	33.25
22.50	17BP4	15.75		21KP4	38.50	

PRICES SUBJECT TO CHANGE WITHOUT NOTICE

\$20 WORTH OF ELECTRONIC PARTS IN GRAB-BAG consisting of: Porcelain sockets, coils, speaker, transformers, resistors, condensers, etc. ONLY \$1.98 (plus tax)

**TAPE RECORDERS—Famous Brand**

List Pr. \$249.95. SPECIAL \$179.95  
List Pr. 199.95. 129.00. List Pr. 79.95. \$59.95  
Write for complete illustrated details.

**WINDOW FANS**

VORNADO—18" Blade—Reversible—List \$89.95 SPECIAL \$47.95 net  
FRIGID—20" Blade—6 speed—Reversible with Thermostat control—List \$89.95. SPECIAL \$47.95 net  
Westinghouse in stock—write for full details

**AIR CONDITIONERS—Famous Brand**

3/4 TON 110V... \$199.95  
G.E., Fedders, Mitchell, Westinghouse in stock  
Write for full details and prices

**Sensational VOCALINE TRANSEIVER**  
(Featured in Radio News—June p.144)  
NEW low-priced 2 way radio—transmits and receives upwards of 10 miles—OPERATES on AC or DC—PORTABLE—COMPACT (9"x6"x5") FCC approved (station license easily obtained)  
WRITE FOR ILLUSTRATED DETAILS AND PRICES

TRANS-ATOMIC TRANSISTOR RADIO...KIT \$6.95  
Same place as above with 2 tone carrying case \$7.95  
SENSIPHONE EARPHONES—Single Phone...\$1.50  
Double Phone...\$2.50  
GERMANIUM DIODE Loopstick Radio Kit...\$3.25

**AM-FM-SW AUTO RADIO**  
Drift Free FM—World's Finest—Becker LeMans  
For PUSH BUTTON 2 way radio—transmits and receives  
For SIGNAL SEEKER...\$239.95  
Includes: GE SPEAKER with GRILLE and AUTOMATIC ELECTRIC ANTENNA. Simple installation for all cars. Specify 6 or 12 Volt system.

VM 3 SPEED HI-FI CHANGER—Model 950 with Ronette Sonotone or Astatic flip-over cartridge—BRAND NEW ORIGINAL CARTONS...\$21.49

VM 4 SPEED HI-FI CHANGER—Model 1210 with Ronette Sonotone or Astatic flip-over cartridge...\$22.95  
RC458-4 SPEED COLLARO—BRAND NEW SPECIAL \$29.95  
45 RPM SPINDLE for above...\$2.98

3 SPEED PORTABLE RECORD PLAYER with MONARCH CHANGER—Ronette cartridge—Portable Two Tone Carrying Case...\$32.95  
WEBSTER Model 140—3 SPEED Automatic with Ronette Sonotone or Astatic flip-over cartridge...\$22.49

MONARCH 3 SPEED AUTO. INTERMIX CHANGER with crystal cartridge...\$21.95  
Same with British variable reluctance...\$24.95  
45 RPM SPINDLE...\$1.88  
TU-5 MONARCH 5 Speed MOTOR & TURN TABLE UNIT (less arm)...\$4.95

PEERLESS PORTABLE BATTERY OPERATED RADIO—Colors: Green, White, Red or Blue—5 TUBE IMPORT. \$14.95 less battery  
BATTERY KIT for above...\$2.00  
JEWEL—Model 5200—5 TUBE AC-DC RADIO...\$12.50

RECORDING TAPE—Top quality—1200 Feet—Famous brand—BOXED—1 to 5—\$1.69 ea. 6 to 11—\$1.59 ea. 12 or more...\$1.49 ea.

**HALLICRAFTERS TV**  
17" PORTABLE TV...Dealer net \$103.95  
Model 17TS700M—Table Model...Dealer net \$1.95  
Model 21TS460M—Table Model...Dealer net \$129.49  
SETCHELL CARLSON—17" PORTABLE TV...\$119.95

**HI-FI PACKAGE DEAL**  
Includes: JENSEN K210 SPEAKER. MONARCH AUTO-MATIC CHANGER with GE RPK 050. 12" SPEAKER ENCLOSURE in BLOND or MAHOGANY WOOD (Specify color). MATCHING BASE FOR CHANGER. 10 WATT HI-FI BODEN AMPLIFIER. Complete, ready to play. A \$135.00 net Value for Only...\$99.50  
or your choice of similar units at relative package price. Write for prices.

**DEALERS:** Write for low cost prices and catalog on '56 models—HALLICRAFTERS, CRESCENT, FANNON, SONORA, WILCOX-GAY, TECHMASTER, G.E., WESTINGHOUSE, TUNG-SOL, WESTING, DELCO, GEN. MOTORS. Address all inquiries to Dept. RN-7.

**COMPLETE HI-FI DEPT. SEND US YOUR LIST FOR LOWEST QUOTATIONS ON ANY ITEM.**

We invite export inquiries and offers. Our export department will give special attention to expediting foreign orders at minimum commission. We are authorized distributors for United Motors, all Delco and Gen. Motors Auto Radio, Parts in stock. We also carry a complete line of popular makes of Radio Tubes at 50/10 discount. Also many other special purpose and transmitting tubes, and all electronic parts and equipment at lowest prices. Send us a list of your requirements for prompt quotations. Terms: 20% with order. Balance C.O.D. All prices F.O.B., NEW YORK Warehouse. Minimum order \$5.00. Write for our latest price list and Hi-Fi Catalog RN-7.

**STAN-BURN RADIO and ELECTRONICS CO.**  
558 CONEY ISLAND AVE. • B'KLYN 18, N. Y.

service dealer must have a certified technician's license or regularly employ a full-time certified technician. Employees working under the direction of a certified technician are not required to have licenses.

The requirements for a certified technician's license are that the applicant must be over 21 years of age and have four or more years' experience in servicing receiving equipment or have technical training (trade, college, or correspondence school) equivalent to two years with a minimum of one year's experience. The cost for a service dealer's license is \$25 annually and that of a certified technician \$10 annually.

The San Francisco Bay area TV service associations and the International Brotherhood of Electrical Workers Local 202, concluded an agreement recently on a unique labor-management contract. The contract was described as a "bombshell that will slaughter the 'sundowner' and force the cut-rate shops to raise both their prices and their standards."

The major stipulations of the contract include a \$4.50 minimum service charge; shops to be closed by 7 p.m., overtime or premium pay for Saturday and Sunday work; owners of one-man shops as well as the owners of the large shops to become union members. Under the reciprocal provisions of the contract, TV service shops affected by it would become union shops; the union, in turn, would take over the job of policing the industry by picketing non-union shops that charge less than the \$4.50 minimum and picketing the homes of set owners who use the services of a cut-rate shop or a "sundowner." Additional pressure would be put on the "sundowner" by working for stiffer enforcement of city and county zoning regulations and for a radio and TV service state licensing law.

The five TV dealer and service associations in Philadelphia have teamed up in an aggressive drive to clean up the service situation in that area. They are winning the cooperation of their local distributors through their aggressive campaign to rid the area of the TV bargain tube racketeers. In a recent newsletter, Ed Lane of the Television Service Dealers Association said:

"Our distributors do not have time to hear each individual gripe. They do have time to sit down with representatives of an association and try to correct some of these evils. We don't know of any distributor who would refuse an association request for a discussion concerning a problem. Our distributors are, in general, upright men with honest intentions. I rather think they are just becoming aware of our collective voice. While we have been crying in the wilderness in the past, we are now being heard because more of you are backing us up in our fight for decent conditions within the industry."

## RADIO ELECTRONIC SURPLUS

**APG 15 INDICATOR**  
Easily converted to a MODULATION INDICATOR Unit contains a 2AP1 tube with shield; also 9006 tube, miscellaneous potentiometers and resistors.  
Brand new...\$5.00 each  
Conversion data to miniature modulation indicator with schematic...\$1.50



**DBM METER**  
0-200 microamp. Full scale. Hermetically sealed in 2" case. Manufactured by Marlon. Brand new.  
Each, postpaid...\$3.50



**NAVY TRANSMITTER**  
T-19/ARC-5  
3-4 mc.....\$5.00 each  
T-21/ARC-5  
5-7 mc.....\$4.00 each  
Slightly used; excellent condition.



NOTE: No C.O.D.'s. Enclose full amount of purchase with order. All merchandise F.O.B. Pasadena, California, unless otherwise specified.

**C & H SALES CO.**  
2176 E. Colorado St., Pasadena 8, Calif.

**Crystals**  
BUY NOW AND SAVE UP TO 90%

**NEW LOW PRICES! NEW SAVINGS! Get the dope!**

NOVICE, FT-243  
FT-171, FT-241,  
FT-249, DC-34/35  
SHIP BAND, MISC.

**SAME DAY SERVICE!**  
SATISFACTION GUARANTEED!  
OVER 5,000 FREQUENCIES!

**SEND FOR FREE CATALOG**

"The House of Crystals"  
**U. S. CRYSTALS, Inc.**  
1342 S. La Brea Ave. Los Angeles 19, Cal.

**LAM FLUX**  
ALUMINUM SOLDERING FLUX  
The miracle you have been waiting for. Throw away your nuts, bolts and rivets. With this flux you solder ALUMINUM the same as other metals. Send \$2.00 Cash, Check or M.O.—No C.O.D. Postpaid in U.S.A.  
E. Lampe, P.O. Box 371, Lindenhurst, L. I., N. Y.

**WANT A BETTER JOB? BECOME AN ELECTRONIC ENGINEER**  
ONLY 32 MONTHS TO EARN A BACHELOR OF SCIENCE DEGREE IN ELECTRONIC ENGINEERING  
Class enrollment limited to allow for individual instructions. Chartered by state of California. NonProfit-nonsectarian. Accredited—established 26 years.  
**APPROVED FOR VETS—ENROLL NOW!**  
SEND FOR FREE CATALOG  
**PACIFIC STATES UNIVERSITY**  
1516 S. Western Ave., Dept. O, LOS ANGELES, CALIF.

## Realistic High-Fidelity

(Continued from page 61)

in this way and, as I have shown, a straight-sided cone is not very good from the point of view of high note diffusion. Bakelite of this type is strong, resists wave-motion along the material, and gives extremely good treble response. I made many thousands of speakers in the nineteen-thirties with cones of this material, but finally abandoned it because of the manufacturing difficulties and the focusing of the highs.

Molded paper pulp is now used almost universally because it is cheap, light, comparatively strong, and can be given almost any shape. Moreover the outer surround can be incorporated with the cone and such intermediate corrugation as the designer may call for are easily provided. Inspection of such a cone must, however, be particularly directed towards any apparent varnish applied to the paper. Without varnish the material is hygroscopic and the cone will become limp in a humid atmosphere, spoiling the response at all frequencies; too much varnish, intended to make the cone stiffer, will only add to the weight, reduce transient response, and do nothing to improve the output at high frequencies. A simple test for varnishing is to wet a fingertip and press the surface of the cone; if the moisture seems to be absorbed like it would with blotting paper it can be assumed the speaker must be kept very dry to give its best performance.

Some cones will, however, show a glazed hard surface for a few inches near the apex; this is due to hot pressing between dies after painting with Bakelite varnish and is intended to help the treble response. Only the apex of the cone propagates the highs and obviously the cone "breaks up" in the process; the purpose of the Bakelising is to restrict the break-up to the zone beyond the apex, so that the extreme treble response is under control.

The flexibility of suspension can be checked by grasping the cone between the thumb and index finger of each hand across a diameter, the thumbs in front of the cone, the fingers inserted through the cone basket. The cone is then gently pulled forward and backward and an estimate made of the amount of permissible movement. When this has been determined, reference back to Fig. 13 will show what performance can be expected at the low frequencies. If, for example, a loudspeaker with a 12-inch cone has less than a quarter-inch free movement it cannot reproduce a 40-cycle note with 5 watts input because it will be overloaded. There will be no 40-cycle output, a little at 80, and most at 120 cps. This refers only to the freedom of suspension; other factors involving the magnetic system and dimensions of the voice-coil will be discussed later.

(To be continued)

July, 1956



**METER OVERLOAD PROTECTION AND OVERLOAD SIGNAL LIGHT.** It is fused to prevent most common burn-outs and instrument damage. The 666 has complete meter movement overload protection. An overload signal light warns the operator of overloads, or incorrect polarity.

### RAPID, RELIABLE AND ACCURATE MEASUREMENTS

43 Unduplicated Ranges.  
Long (4 7/8") Scales are Color-Coded for clarity.  
Illuminated Dial for easier reading.

**AC CURRENT RANGES (from 1.5 MA to 15 Amps) MEAN FEWER INSTRUMENTS TO CARRY**

### RELIABLE PERFORMANCE

Doubly Shielded 45 UA movement assures continuous accuracy.  
Permanent Accuracy 3% DC, 4% AC.  
Sensitivity: 20,000 Ohms/Volt DC, 2,000 Ohms/Volt AC.

### CONVENIENT TO CARRY

This instrument, with its unbreakable steel case, fits into the provided handsome leather carrying case which has space for all accessories.  
Lightweight: 4 lbs. 4 oz.  
Compact: 3 3/4" x 6 5/8" x 7 1/2".

Complete with Probes, Power Cord, Batteries and Leather Carrying Case at your Parts Distributor. **\$59.50**

**PHAOSTRON INSTRUMENT AND ELECTRONIC COMPANY**

151 Pasadena Avenue, South Pasadena, California

EXPORT: Ad. Corliss, Inc. 88 Broad St., New York 4, N.Y.

**COMMAND  
ARC-5 TRANSMITTER**  
T-20...4 to 5.3 MC  
T-21...5.3 to 7 MC



Brand New... \$495  
3 to 4 mc. like new... \$5.95  
**Command Equipment  
(274N-ARC5, ATA)**

Model	Less Tubes As is	Excellent Used	Brand New
<b>RECEIVERS</b>			
520-1500 KC ...		\$14.95	\$19.95
1.5-3.0 MC ...		7.95	9.95
3-6 MC ...	\$2.95		
<b>TRANSMITTERS</b>			
2-1-1 MC		9.95	
T-23/ARC-5 UHF 2 METER TRANSMITTER—This terrific command transmitter has turret switching coils for all stages. Uses 1825 Osc.; 825 Tripler; 832A Tripler; 832A Final; 10B25 mc. Channels are provided using 4 separate coils in an automatic turret using 12 or 24V motor or a manually operated system. These coils can very easily be re-wound for 6 and 10 meters. Complete with all Tubes. Excellent condition \$9.95.		\$18.95	
Brand New			\$11.95
R28—Companion receiver for above. Used Exc.			\$11.95

**LORAN EQUIPMENT**

Marine or Airborne Long Range Navigational equipment! Determine the exact geographic position of your boat or airplane!  
AN/APN4 Loran set. Frequency range 1700-2000 KC. complete with 1D6B/APN4 indicator, R9B/APN4 receiver, crystal and plugs.  
Complete ..... Brand New **\$129.50**  
AN/APN-9 Brand New ..... \$295.00  
(Quantity prices available—write)

**\$4500 HI-FI Headset for only \$7.95**

Uses annular grooved plastic fibre comes with voice coils as in speakers, and brand new chamois ear pads to obtain spacing for correct acoustical load. GIVES FINEST MUSIC REPRODUCTION. Each cable wired separately, with plug for binaural sound. Imp.: 300 Ohms per unit or 600 Ohms when wire in series. Brand new in original carton. .... **\$7.95**  
USED EXC COND ..... \$4.95  
RT-24/APX-2 IFF EQUIPMENT. 44 tube transceiver, 11-6AG5, 10-6C4, 7-6J8, 2-9006, 1-VR150, 1-5Y3, 1-2021, 2-2C26 with usable parts, tube sockets, relays, coax fittings, condensers, resistors, etc. 24 volt Blower motor, 24V gear train motor. Power transformer 400 to 2400 cycles. Original govt. cost \$750.00.  
Brand New. Complete with tubes... ea. **\$14.95**

**A Sweet Oscilloscope Deal**

INDICATOR. With 5CP1, mounted and shielded, with high-voltage divider network, focusing, intensity, horizontal & vertical positioning controls, and double-deck chassis with octal sockets for up to 27 tubes, plus 22 potentiometers, and resistors & capacitors. Light all aluminum, 9" x 12" x 19". New with 5-CP1. Less tubes and crystal. Only... **\$9.95**  
Freq. Meter—Cavity tuned-absorption type—110 VAC 60 cycle 150 to 240 Mc. .... **\$24.50**  
Like New ..... \$24.50  
100 to 127 Mc—Like New ..... \$24.50  
PE-109 Inverter 12VDC input, 115V, 1.5 amps., single phase, 400 cycle output, ..... **\$39.50 ea.**  
Brand New ..... **\$5.45**  
H5-33 600 Ohm—New ..... **\$5.45**  
H5-23 Hi-Imp. headphones—Brand New... **\$5.45**  
T5-9 Handset—Complete with cord & Butterfly switch. Brand New Original Cartons... **\$6.95**  
10 for ..... **\$60.00**  
T-26 Mobile Chest Mike. Brand new... **\$1.29**

**TWO METER VHF TRANSCEIVER**

RT-19/ARC-4 Transceiver complete with all tubes in excellent like new condition. Each **\$19.50**  
BC 906 Cavity type freq. meter. 144 Mc to 295 Mc. Complete with antenna and operating manual. Brand new—Orig. factory pack. .... **\$14.95 ea.**

**SURPRISE PACKAGE**

20 lbs. of MISCELLANEOUS ELECTRONIC EQUIPMENT—WORTH MUCH MORE than this low price of ONLY... **\$1.95**

**DYNAMOTORS**

Type	Input	Output	Used	New
BD-77	12 VDC	1000 VDC	350 MA.	\$14.95
BD-83	12 VDC	375-150 MA.		1.95 \$4.95
DM-64	12 VDC	275 VDC	150 MA.	3.95 5.95
DM-34	12 VDC	220 V	80 MA.	2.95 4.95
DM-35	12 VDC	625 VDC	225 MA.	Exc. Cond. 9.95

PHONES—Sound Powered, Reconditioned and Tested. .... ea. \$ 5.95 pr. 11.00

MOBILE HEAVY DUTY DYNAMOTOR: 14 V. INPUT-output: 1030 VDC 260 MA. Tapped 515 V. 215 MA. use or 6 V DC INPUT-500 V. 175 MA. While they last—DM-42-Excel. Condition. \$4.95 Brand New ..... **\$9.95**

**APG 5 or 15 CAVITY**

10 Cm. 2C43 osc Xmitter, 2C40 Loc. Osc. Rec. 1B27 TR; tunes 2400 to 3000 MCS, less tubes. Price ..... **\$4.95**

**Receiver-Radio**

Navy type 300KC to 23MC. Designed for optimum performance for the reception of pure modulated or interrupted CW. **\$49.50**  
Used Exc. .... **\$2.95**

CRYSTAL—100 KC. .... **\$2.95**  
MG-149F—110V AC, 400 cycle-750 VA Inverter. Used. .... each **\$9.95**

**WRITE FOR NEW BULLETIN AND PRICES.**

ALL ITEMS F.O.B. CHICAGO  
25% Deposit required with orders

**R W ELECTRONICS**

Dept. N, 2430 S. Michigan Ave., Chicago 16, Ill.  
PHONE: CALUMET 5-1281-2-3



**COLOR TV PROMOTION**

An advertising and merchandising tie-in between *Cluett Peabody and Co., Inc.*, manufacturers of "Arrow Shirts" and the *RCA Television Division* has been developed for presentation this Fall.

Developed around the theme "The Look of Compatible Color," the program includes two full-color double-page ads in "Life" and the "Saturday Evening Post" plus additional promotion on the *RCA-sponsored color TV show, "Producers' Showcase."*

In addition to the advertising portion of the program, special window displays have been prepared for department stores. These will be augmented by promotional kits, including window streamers, point-of-sale displays, radio and television spot announcements, and other material.

**SOLDER PACKAGE**

*Kester Solder Company*, 4201 Wrightwood Avenue, Chicago 39, Illinois has come out with a new solder package



especially for the TV and radio service trade.

The new package is a pocket- or kit-sized edition of the firm's "Resin-Five" core solder which is non-corrosive and non-conductive. In addition to the new individual packages, the company has a counter display which holds ten of the new boxes.

Write the company for information on both the product and the display.

**WESTINGHOUSE CAMPAIGN**

*Westinghouse Electric Corporation* has launched an intensive campaign to obtain an annual consumer sales figure of one billion dollars.

The campaign will consist of a "product pre-sell" campaign using local papers and local radio; a dealer campaign; multi-color institutional ad insertions in major magazines; TV program spots; sponsorship of national political campaign coverage; dealer-aid program consisting of displays,

consumer literature, demonstration devices, co-op advertising, etc.; and a schedule of ads in trade and technical publications.

**DRIVE DISPLAY**

*Walsco Electronics Corporation*, 3602 Crenshaw Boulevard, Los Angeles 16, California has developed a complete merchandising unit for its line of phono-recorder drives.

The compact display holds an entire line of vital replacement parts for



every major phonograph and tape recorder, old or new. In only 25% more space than originally used, the new display is said to stock twice as many belts and drives as any other display of this type.

Included in the display are all the new 1956 motor drives (domestic and foreign). A sample of the contents of each compartment is affixed to the outside of the display doors for speedy self-service and permanent inventory.

Write the company direct for complete information about the display and the line.

**BATTERY MERCHANDISER**

A combination floor, wall, or counter display, designed to solve the space problem confronting radio supply dealers, is now being offered by *Ray-O-Vac Company*, 212 E. Washington Ave., Madison, Wisconsin.

The sturdy radio battery merchandiser is specially constructed of wrought iron and selected woods for



modern, permanent construction. Designed as a three-way display, it makes a floor stand or with the re-



removal of the legs it can be used on the counter or hung on the wall.

For information on how dealers can obtain this display without charge, write the company direct.

\* \* \*

#### RADIO CHEMICALS

General Cement Mfg. Co., 919 Taylor Avenue, Rockford, Illinois has introduced a convenient new display to facilitate the merchandising of radio chemicals.

Twenty-four different products and colors are featured on the new display. Such "Spra-Koat" items as "De-Ox-Id," "Spra-Kleen," wrinkle varnish, touch-up varnish, enamels, flat paints, and many others are included.

\* \* \*

#### "SCENTS INTO DOLLARS"

CBS-Columbia is helping its dealers turn "scents into dollars" with a "sweet-smelling, sweet-selling" premium promotion.

Customers will be invited to pick up a free gift of "Sortilege" perfume at their CBS dealers' showrooms, thus giving the dealers an opportunity to present the 1956 line of TV receivers.

The company is supplying complete promotion kits to its dealers.

\* \* \*

#### DELCO TUBE CARTON

The United Motors Service Division of General Motors has introduced a



new, more distinctive carton for its line of "Delco" electron tubes.

The colors of the new radio tube cartons and picture tube labels make product identification easier and more pleasing to the eye.

The white and orange lettering on the new packages used against a dark blue background is easier to read at greater distances. The new packages also provide adequate space for proper type number identification.

\* \* \*

#### NEEDLE KITS

The Recoton Corporation, 52-35 Barnett Ave., Long Island City 4, N. Y. is currently offering a colorful sales brochure which lists its various needle kits and other sales promotional aids.

The company has guides, brochures, display cards, envelope stuffers, etc., available in addition to a wide assortment of needle cards.

-30-

July, 1956

**new!** **twins by ARKAY**



**Arkay Model HFT-7 Hi-Fi, AM-FM Tuner Kit**  
Matching tuner which offers less than 1% distortion and a -70db hum level. Sensitivity is 6 uv for 20 db quieting on FM and 20 uv on AM. FM selectivity is 200kc. . . bandwidth 8db down; AM, 8kc bandwidth 5db down. A unit to suit the discriminating tastes.  
With AFC control and defeat **\$29.95**  
Available in FM only **\$23.95**  
Less Cover



Williamson type super-linear amplifier with built-in pre-amp. Pushpull 12 watt output frequency response  $\pm 1$  db, 10 to 40,000 cps with extremely low IM and harmonic distortion. An amplifier to be proud of. **\$28.95**

---



**Arkay Miniature Radio**  
Superheterodyne circuit and hearing aid type ear piece. 5 3/4" x 3 3/4" x 1". **\$12.95**



**Arkay Model A-12 Hi-Fi Amplifier Kit**  
12 watt output . . . 5 inputs. Master controlled at front panel. **\$22.95**



Testing Kits



Television Kits



Radio Kits

Visit your local distributor for these wonderful kits and write today for the special FREE Radio Kits Catalogue and list of dealers. Your copy will be sent by return mail with no obligation. Write to . . .

**Radio Kits Inc., Dept. 7** 120 Cedar Street, New York City

" GRIP " PRESENTING THE *New* **SPINTITE**®  
PATENTS PENDING  
**WRENCHES**

WITH THE EASY "FINGER-CONTROL"  
**GRIP AND RELEASE ACTION**  
FOR THOSE  
**HARD-TO-GET-AT PLACES —**



→ PUSH SLEEVE TO GRIP NUT

← PULL SLEEVE TO RELEASE

FINEST QUALITY STEEL SHANK AND SLEEVE  
BRIGHT PLATED FINISH  
STRONG PLASTIC HANDLE

SIZES 3/16" TO 1 1/16"

BY THE MAKERS OF THE ORIGINAL **SPINTITE** WRENCHES  
OVER 150 STYLES AND SIZES

ONE HAND OPERATION—

- GRIPS nuts or bolts of any material
- HOLDS firmly in any position
- TIGHTENS nut or bolt securely
- RELEASES at the pull of the fingers

STEVENS WALDEN Inc.

450 SHREWSBURY STREET — WORCESTER, MASSACHUSETTS  
MAKERS OF WORLD-FAMOUS HAND TOOLS FOR OVER 50 YEARS

# HERSHEL'S SUMMER SPECTACULARS!

**OIL CONDENSER**  
**\$165**  
 2 MFD. 3000 VDC. Pyramol oil w/ mounting brackets.  
 1-1 MFD. 3000 VDC. removed from equip. 4 3/4" x 4 1/4" x 2 1/2"

**PHOTO ELECTRIC CELL**  
**95¢**  
 CE Vacuum Cell used in Sound Projector. Also useful for opening garage doors and Alarm Systems.

**GE Pyramol Oil CONDENSER**  
**95¢**  
 12 MFD. 330 VAC. 60 VAC. Removed from equip. NEW.

**30 TUBE SOCKETS.**  
 Subminiature, 7 & 9 pin miniatures, 4 to 8 pins. Mica-filled & ceramic shield base type. 50¢ ea.

**2000 PCS. HARDWARE.**  
 Radio, TV, shop, wood-working screws, springs, grommets, etc.

**40 MOULDED CONDENSERS.** Best known makes! .0003 to 0.1 mf to 1000V.

**30 CERAMIC DISC CONDENSERS.** 5 mmf to .01 mf. to 1000V. TV repairman's note.

**2 TUBULAR ELECTROLYTICS.** Popular values to 450V. Top makes, axial leads.

**60 KNOBS.** Instrument, radio, TV types. Push-on & set screw types. Some 35¢ ea.

**10 PANEL SWITCHES.** Micro, car, momentary, push & rotary. Wide variety.

**80 TUBULAR CONDENSERS.** 25 values! .00033 to 1 mf., up to 6000V. Oils, too.

**10 PP & TWIST ELECTROLYTICS.** Ass'd. to 1000 mfd. to 450V. Some multiples.

**100 COIL FORMS.** Experimenters, note! Wide variety of shapes & sizes. Ceramic and Bakelite.

**80 CARBON RESISTORS.** Insulated. 35 values. 15 ohms to 10 meg. 1/4, 1/2 & 3/4 W. 5¢ tool incl. famous Allen Bradley!

**SAVE \$7.07**  
 on this new  
**6-Position INDOOR ANTENNA**  
 Reg. \$10.95  
**\$3.88**  
 Complete  
 Improves TV Reception or You Get Your MONEY BACK



**YOUR CHOICE ANY KIT LISTED IN THIS AD 97¢**

**50 MICA CONDENSERS.** Rare offer! Postage stamp types. 25 values. .00001 to .01; to 1200 VDC. Many silver. 50¢ ea.

**125 CARBON RESISTORS.** 30 values; 100 ohms to 1 meg; 1/4, 1/2, 1 watt. Many 50¢. Un-insulated.

**30 POPULAR BULBS.** Special! Wide variety standard, miniature, screw and bayonet types. 1.5¢ thru 6V.

**12 LINE CORDS. AC/DC cords; molded plugs. For all electrical eqpt. Stock up now!**

**50 CERAMIC CONDENSERS.** Tubular, disc, button & standoffs! 5 to .01 mmf to 1000V

**12 VOLUME CONTROLS.** Handy, shop standard, electrical, TV, lab units. Some WW.

**50 RF COILS & CHOKES** and slug-tuned coils for TV, radio, lab. 20 types.

**20 POWER RESISTORS.** Wirewound. 20 values. 5 ohms to 12,000. 5 to 50 watts. Candohm & tubular types.

**All New MYSTERY PACKAGE of ELECTRONIC PARTS**  
 It's the surprise of your life! 20 pounds of BRAND NEW usable GOVT. surplus. The ideal gift for hams, etc.  
 Worth \$40.00  
 Our Price **\$3.95**  
 Ship wt. 20 lbs.



**PICTURE TUBE BRIGHTENER 94¢**

TERMS: Cash with order or 25% DOWN-BALANCE C.O.D. ALL PRICES NET F.D.B. DETROIT MINIMUM ORDER \$2.00

**HERSHEL RADIO CO.** TYler 8-9400  
 5249 GRAND RIVER Detroit 8, Michigan

**NEW CATALOG!**  
 • INDUSTRIALS! • LABS!  
 • ENGINEERS! • HAMSI  
 • EXPERIMENTERS! • NOVICES!  
 Are You on Our Mailing List?  
 If not, write us today for free copy!

**MINIATURE HAND CRANK GENERATOR**  
 Latest type, light weight. From recent model field phone. Many uses. Brand new. **\$1.49**  
 Terrific deal!

**CHEST MIKE.** Used. Ea. **49¢**

**HI-FI PENNA-FLUX HEADSET:** Annular grooved plastic fibre cones with voice coil as in speakers. Chamols car pads. Gives finest music reproduction. Brand new in original carton. **\$7.95**  
 Special. Only one!

**NEW CATALOGUE NO. 110 IS OFF THE PRESS!**  
 Get your free copy today!  
 All items F.O.B. L.A. Prices subj. to change without notice. Calif. buyers add tax. Send 25% deposit with C.O.D. orders.  
**J. J. GLASS ELECTRONICS CO.**  
 1615 S. Main St. Los Angeles 15, Calif.

# Using Your Test Equipment

By MEL BYRON  
 Vice-President for Engineering  
 Precise Development Corporation

*The tube tester can be very valuable—and it can be trusted—but it must be used within its limitations.*

THE tube tester is certainly thought of with mixed feelings. Here is an instrument which is supposed to be able to indicate whether a vacuum tube is good or bad—and tubes are the leading cause of trouble in electronic equipment. It can literally save thousands of troubleshooting dollars, yet it is often not trusted, and more often not used. Some service technicians relegate it to the position of a "tube seller." Why this is true and ways of making the tube tester more effective in a service shop will be discussed here.

Let us consider what is required of a tube tester to properly test a tube:

1. It should, if possible, simulate the circuit in which the tube is normally used. Plate, screen, suppressor, control grid, and heater voltages and currents should be applied to the tube under test which are similar to those under actual operating conditions.

2. The tube should be tested for at least its most important characteristic. In the case of a power tube this would be plate current; for an i.f. or r.f. amplifier it would be  $G_m$ . Since power is a function of voltage and current, a power tube should be capable of delivering large currents. For such a tube, therefore, the plate current is of prime importance. In the case of an i.f. or r.f. amplifier tube, the voltage gain of a stage is the  $G_m$  (the mutual transconductance) times the load impedance. Here the stage gain is directly proportional to the  $G_m$  of the tube, making it the most important factor.

3. A gas test should be provided. One example of the effects of excessive gas in a tube is clipping. This is particularly annoying in the i.f. section of a TV set where the sync pulse may be clipped off, thereby causing poor horizontal synchronization. The problem of gassy tubes is not as noticeable in radio as it is in TV since, in radio, the general effect is an increase in distortion. In TV, sync is actually affected and the picture will tear or run.

4. A simple and effective short test should be provided. This is most often accomplished by means of a neon bulb with a resistor across it and another in series with it. The sensitivity of this circuit can be set by adjusting the two resistors. They are usually adjusted so that the bulb will light for leakage of 1 megohm or less.

The aforementioned lists the most

important general conditions for tube testing. The question is, "why, if these conditions are met, can't we trust a tube tester?" The answer, of course, is that most tube testers do not meet all of these conditions. Certain short cuts have been taken in most instruments, primarily to keep the cost down, which limits the tests being made. If you understand the instrument which you currently have and realize its limitations, it will be able to serve you better.

There are many reasons why the service technician does not find his tube tester completely accurate. A few are listed here with suggestions for the proper use of tube testers.

Some tube testers check multi-element tubes as diodes. These testers have the advantage of being relatively inexpensive but their usefulness is limited. Most tube testers measure either  $G_m$  or emission. Determine which type you have and use its readings accordingly;  $G_m$  for i.f. amplifiers, and emission for power amplifiers.

Voltage and current conditions for the tube under test are not properly met in some checkers. This depends on the particular type of tester. A diode type does not meet the voltage conditions. This could account for a 6BG6 testing "good" on such a tube tester, but not working in a set. If the tester only draws 5 or 10 milliamperes of plate current, it certainly is not able to detect a weak power tube.

There are some tests that cannot be made intelligently by present-day tube testers without undue expense. These include checking high-voltage rectifiers and u.h.f. oscillators. A tube like a 1B3 should actually be tested with at least 9000 volts applied to its plate. It is impractical to test these tubes for anything more than emission in a conventional tube tester. Since a defective 1B3 tube shows up so effectively in a TV set, no attempt has been made to develop this high voltage in testing.

Faulty u.h.f. oscillator tubes will usually show up on a  $G_m$  test. However, when the problem has to do with transit time, the frequency of the voltage applied to the tube grid would have to be about 400 mc. to have any value. This is not practical in service-type tube checkers.

Many service technicians rely solely on tube substitutions for testing defective tubes. Tube substitutions are fine when it's a matter of replacing

one tube, but if the problem has to do with 4 or 5 weak tubes in an i.f. strip, replacing one probably won't make much difference. If all were replaced, and the set retouched in alignment, the change would be tremendous.

If desired, there are tube testers available which meet all the requirements for effective tube testing. Such a tester should be the greatest asset a service shop has. However, your present instrument, if used within its limitations, can be of great help and, when used correctly, can be trusted as well as a voltmeter.

-30-

### 21ST ANNUAL HAMFEST

THE Glacier-Waterton International Peace Park Hamfest has been scheduled for July 21 and 22 at Apgar Camp Ground, West Glacier, Mont., on Lake McDonald in Glacier National Park.

For full details write or contact Frank B. Hart, W7UPR, Route 1, Sunset Drive, Kalispell, Mont., secretary-treasurer of the Glacier Park Hamfest.

All are invited and an unusual program has been planned.

-30-

### SENSITIVE RELAY SWITCH

By GORDON MILLS

A SWITCH with a current rating of only one microampere will close the relay to be described here. It is useful in conjunction with a sensitive thermal switch as well as with many other types of low-current switches that are required to close a relatively high-current circuit.

When finding the value of  $R_2$ , the voltage between points "A" and "B" in Fig. 1 should be approximately 55 volts so that the current through the relay coil is normally between 1 and 10 ma., depending on the relay used. The value of  $R_2$  will usually be between 10,000 and 20,000 ohms.

The value of  $C_1$  may be anything over .01  $\mu$ fd. However, as  $C_1$  increases, more current is sent through the switch, reaching a maximum of about 8 microamperes with no capacitor at all. The value for  $C_2$  given on the diagram will cause a slight delay in the opening of the relay. By decreasing the value of  $C_2$ , the delay will be shortened. Conversely, increasing the value of  $C_2$  will increase the delay.

When the switch is closed, an a.c. potential from the filament is impressed upon the grid of the tube through  $C_1$ . This potential is of such a phase that it stops the tube from conducting and thus opens the relay.

-30-

Fig. 1. Schematic of circuit designed to be used with sensitive thermal switches or other types of low-current switches.

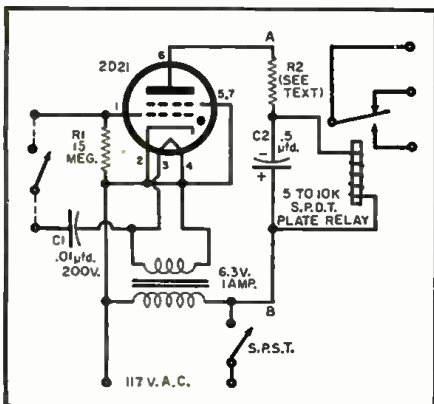

## planning to buy a sports or economy car ?



Check the specifications and performance of today's light cars

before you buy. For complete and accurate data, read the Buyers'

Guide section of July SPORTS CARS ILLUSTRATED!

July SPORTS CARS ILLUSTRATED—

**ONLY 35¢**

now on sale at all newsstands



ZIFF-DAVIS PUBLISHING CO. 366 Madison Ave. New York 17, N. Y.

THE MUSICAL MASTERPIECE SOCIETY INVITES YOU TO ACCEPT

# FREE

## BEETHOVEN'S 9th SYMPHONY Plus Beethoven's 1st and 8th Symphonies

Netherlands Philharmonic Orchestra and Chorus Under the Baton of Walter Goehr

All Three Symphonies Complete

To The Last Note! The Most Astounding Record Offer Ever Made!



To demonstrate the amazing value, the magnificent artistry of the Society's recordings take this majestic new album of BEETHOVEN'S NINTH... plus Beethoven's 1st and 8th symphonies—as a FREE GIFT! No obligation to buy another record ever. We simply want to introduce you to the enjoyment awaiting you in all the new releases listed below. Great masterpieces performed by world renowned artists and orchestras... reproduced on high-fidelity discs encompassing the entire range of human hearing.

Save Over 40% off usual cost

When you send for your FREE GIFT Recordings, you also become eligible to audition FREE any or all of these 30 additional discs at the rate of two a month. Pay only \$1.89, plus shipping, for each you keep. Pay nothing for those you don't want after 5 day trial. FREE GIFT is yours in any case. Mail coupon now!

### THE MUSICAL MASTERPIECE SOCIETY, Dept. 47-7

43 W. 61st St., New York 23, N. Y.

Rush my FREE GIFT album of Beethoven's 9th, 1st and 8th symphonies. Also deliver for a 5 day free home trial the long-playing selections I have NOT crossed off at the right, about two a month. I will be billed only for those I keep — at only \$1.89 plus shipping, per long-playing disc. I may return any recording, and pay nothing. I may cancel my Trial Membership at any time. Free Gift is mine to keep in any case.

Name .....

Address .....

City..... Zone.. State.....

Canada: 105 Bond Street, Toronto 2, Ont.

### Just Imagine the Fabulous Record Collection You Can Build From This List!

(Cross out only those you do not want to audition Free)

1. DVORAK: Symph. No. 5
2. TCHAIKOVSKY: Violin Con. 3.
3. MOZART: Piano Con. No. 24
4. BACH: Magnificat in D
5. BEETHOVEN: "Emperor" Concerto
6. BIZET: Symph. in C
7. VIVALDI: Four Seasons
8. SCHUMANN: Piano Concerto 9.
9. HAYDN: Trumpet-Concerto, and Flute-Concerto
10. SCHUBERT: "Trout" Quintet
11. MOZART: "Jupiter" and 17th Symph.
12. CHOPIN: Piano Con. No. 1
13. BACH: Violin Con. No. 2
14. RIMSKY-KORSAKOFF: Capriccio Espagnol; Mussorgsky: Intro. to "Khovantchina"
15. DEBUSSY: Quartet in G; and Sonata for Cello and Piano
16. BEETHOVEN: "Appassionata" and "Moonlight" Sonatas
17. BRUCH: Violin Concerto; PAGANINI: La Campanella
18. MOZART: Clarinet Quint. in A
19. SAINT-SAENS: Violin Concerto No. 3
20. MOZART: Symph. Nos. 40 & 31
21. GOLDMARK: Rustic Symph.
22. BEETHOVEN: Symph. No. 7
23. CHOPIN: Sonata No. 2
24. HAYDN: "Surprise" and "Military" Symphs.
25. FRANCK: Symph. in D
26. STRAVINSKY: Firebird, and Piano Con.
27. SCHUBERT: Symph. No. 3
28. PROKOFIEFF: Violin Con. No. 1 and Piano Con. No. 1
29. MENDELSSOHN: "Scottish" Symph.
30. DVORAK: "American" Quar.

## BUILD YOUR OWN AMATEUR TRANSMITTERS

from these easy-to-assemble kits!



### VIKING "ADVENTURER" TRANSMITTER

Complete to the last detail, the Viking "Adventurer" is the ideal CW transmitter for the beginning amateur... the perfect standby transmitter for the experienced amateur. Effectively TVI suppressed—professional in appearance and design—easy to assemble and operate! 50 watts input—single knob bandswitching on 80, 40, 20, 15 and 11-10 meters. Packs enough power for world-wide radio contacts with just a simple antenna. Wide range pin-network output tuning—no antenna tuner needed. Kit is furnished complete with built-in power supply, tubes, cabinet, wiring instructions and antenna suggestions.

Cat. No. 240-181-1—Viking "Adventurer" Kit, less crystal and key ..... \$54.95



### VIKING "RANGER" TRANSMITTER

Tops for operating convenience—enough power for world-wide contacts. Built-in VFO or may be crystal controlled. Band-switching 10 through 160 meters. 75 watts CW input, 65 watts phone. Drives most kilowatt amplifiers including the Viking Kilowatt. TVI suppressed—easy to build—professional in appearance. With timed sequence (break-in) keying system. Kit or wired and tested.

Cat. No. 240-161-1—Viking "Ranger" Kit with tubes, less crystals and key \$214.50  
Cat. No. 240-161-2—Wired... \$293.00

For detailed information see your distributor or write to:



**E. F. JOHNSON COMPANY**

3110 Second Ave. S. W., Waseca, Minn.

**DON'T Miss These HOT SPECIALS!**

5" SCOPE SHIELD Mu Metal	51.95
6V Adj. Time DELAY Thermal RELAY 5-180 Sec.	.50
Electronic STROBOSCOPE Stops Motion; w. 1021 SNA Tube. Compl. \$18.95; Mini Sensitive RELAY 4-12V SPDT .95	
Sens. Sigma RELAY 10,000 ohm. Operates on 2 Ma DC & 110V AC. SPDT 95c 10/39 SPST 10/38	each .85
VIBRATORS: 12V DC to 60 Cycle (Freq. Generator) \$1.25	
TUBES: RCA 1S455c; 6V6 50c; 12Y4 15c; RK61 \$3.30; DIODES 2"	
METERES: 150 MicroA. \$3.95; 500 MicroA \$3.95; 3 Ma. 3.95	
10-40 Met. Vert. Sect. ANTENNAS: 16 ft. \$2.95; 32 ft. 4.95	
HYDROPHONE Complete UnderSea Mike & FM XMTR. 9.95	
POWER SUPPLY 110V. AC Input. 165V. @ 40 Ma.	
105V. Regul. @ 15 Ma. 6.3V @ 3 1/2 A. 14x8x8 case	9.95
Diehl PM MIDGET MOTOR 27 VDC—Ball Bearing—1/2" Long shaft. 10,000 RPM 2x11/16"—works on 6V	1.95
Mini 6V. VIBRATOR SUPPLY 90V. @ 25 Ma. 2 1/2" d. x 3 1/4"	3.45
Alum. CABINET 7"x7"x5". Snap-Lock Cover. F.B. Mobile Equip.	1.50
No. 1 EMERY PAPER 9"x11"—50 Sheets	1.35
REAR AUTO SPEAKERS: in 5" PM Chrome Case	1.25
DISCONE ANTENNAS: Hi-Gain 300-3,000 Mc. APR-4	3.95
1% PRECISION RESISTORS 25 Sizes	3.00
Fl. TRANSFORMER: 110-125V AC 2 1/2V @ 15A & 2 1/2V @ 15A	2.95

QUANTITY DISCOUNTS AVAILABLE  
RADIONIC PROD. CO., 325 Canal St., N.Y. 13, N.Y.



"CLOSED-CIRCUIT AND INDUSTRIAL TELEVISION" by Edward M. Noll. Published by *The Macmillan Company*, New York. 227 pages. Price \$4.95. Paper bound.

The fact that eventually industrial and closed-circuit television may exceed, dollarwise, its present application as a medium of entertainment is more than justification for those in the industry to keep abreast of these trends and prepare themselves for the change.

Many technicians are already enjoying the financial and prestige value of working in the industrial TV field and it is a foregone conclusion that more will follow suit. This book is for this group. Not only does it provide information on currently available systems but it suggests new and interesting possibilities for this medium.

One interesting feature of this text is complete construction details on a small television camera which the technician can build for experimental purposes and for experience.

This little book is packed with vital information and the reader will find it worthwhile both as a reference work and as a practical "how-to-do-it" handbook.

\* \* \*

"THE QUEST FOR QUALITY" by N. H. Crowhurst. Published by *Norman Price (Publishers), Ltd.*, London. Available in the U. S. from *British Radio Electronics*, 1833 Jefferson Place N. W., Washington 6, D. C. 77 pages. Price \$1.50. Paper bound.

In tackling a subject of such scope the author freely admits that his discussion must, of necessity, be non-inclusive but within this framework the author has made a good job of it.

The book is divided into ten chapters dealing with such subjects as a discussion of what constitutes the "ultimate" in audio reproduction, frequency response, harmonic and IM distortion, transient response and coloration, flutter and wow, dynamic range and background noise, equalization, stereophonic objectives, system building, and acoustics.

The treatment is non-technical and the copious use of illustrative material makes the text crystal clear to the hobbyist and layman.

\* \* \*

"PHOTOCELLS AND SUN BATTERIES" by John Sasuga. Published by *International Rectifier Corporation*, 1521 E. Grand Ave., El Segundo, California. 58 pages. Price \$1.50. Paper bound.

This handy little book has been prepared especially for technicians, experimenters, and engineers who have

## MOVING?

BE SURE RADIO & TELEVISION NEWS FOLLOWS YOU. SEND YOUR CHANGE OF ADDRESS TO

Radio & Television News

CIRCULATION DEPARTMENT

64 E. Lake St.

Chicago 1, Ill.

## TELEVISION

PREPARE FOR A GOOD JOB!  
BROADCAST ENGINEER  
ELECTRONICS RADIO SERVICING

Television Servicing

(Approved for Veterans)

BUILDING AIRCONDITIONED  
SEND FOR FREE LITERATURE  
BALTIMORE TECHNICAL INSTITUTE  
1425 EUTAW PLACE, BALT. 17, MD.

## the PanaSonic

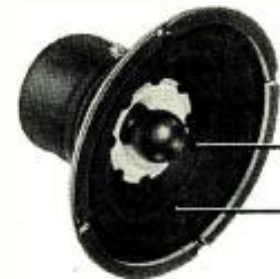

MAGIC  
GLOBE

MAGIC  
RIDGE

At \$24<sup>75</sup>... "An Unqualified Bargain"  
says "High Fidelity Magazine"

"...Equivalent to Many Larger  
and More Costly Speakers..."  
says "Audio Magazine"

Complete findings of experts, as reported in above publications, will be gladly sent to you upon request. Better yet... hear for yourself performance never before achieved by an 8" speaker, thanks to splendid craftsmanship and patented features like "Magic Globe" and "Magic Ridge."

Try the PanaSonic, a product of the world-renowned Matsushita Industries, at OUR risk in YOUR home with YOUR equipment. Take advantage of this opportunity.

**NOW SAVE 20%— Send only \$19<sup>80</sup>**

Windsor International Co., Inc. P.O. Box 7  
Riverside, Connecticut

Enclosed find \$ for PanaSonic Speaker(s) at \$19.80 each, postage paid, together with complete "High Fidelity" and "Audio" test reports, descriptive pamphlet and enclosure recommendations. Money back guaranteed if returned within ten days.

NAME \_\_\_\_\_

ADDRESS \_\_\_\_\_

CITY & STATE \_\_\_\_\_

RADIO & TELEVISION NEWS

been intrigued and stimulated by the possibilities and potentialities of sun-powered radio equipment.

This is a "how-to-do-it" handbook in that practical experimental circuitry is included in the over-all discussion. The book is divided into nine chapters dealing with basic concepts, light-powered devices, light sources and beam illuminators, photoelectric relays and connections, photometers, unusual relays, ultra-sensitive relays, light-beam communications, and miscellaneous applications and demonstration projects.

Complete specifications on a representative selection of commercially available photocells and sun batteries are given for reference. Another feature which will be of interest to the experimenter is the listing of sources for the various components required to build the circuits described.

\* \* \*

"ATTENUATORS, EQUALIZERS AND FILTERS" by Howard M. Tremaine and George K. Tefteau. Published by *Howard W. Sams & Co., Inc.*, Indianapolis. 176 pages. Price \$2.75. Paper bound.

From the number of requests received for practical design information on these important audio system components it is obvious that there is a need for a book of this type.

The authors have rendered a real service to the audiophile since this text describes the design, application, and theory of operation of every conceivable type of attenuator, equalizer, and wave filter.

One especially valuable chapter is devoted to the hi-fi crossover network. Handy charts for determining component values required in designing equalizers and filters are an added boon.

So for all of you who have been looking for data of this type—here is your book crammed with practical information presented in its most usable form.

\* \* \*

"BEAM ANTENNA HANDBOOK" by William I. Orr, W6SAL. Published by *Radio Publications, Inc.*, Wilton, Conn. 127 pages. Price \$2.70. Paper bound.

It is hard to think up a single question about ham antenna construction, adjustment, and operation that is not answered in this fact-packed handbook. Whether you plan to build or buy a beam, your first purchase should be a copy of this book.

The text material is divided into 12 chapters covering transmitting medium, the array, transmission lines, matching devices, the parasitic beam, operational characteristics of the parasitic antenna, the design of parasitic arrays, the construction of all-metal and composite arrays, antenna evaluation, test equipment, and antenna installation.

In addition to the text, hundreds of charts, drawings, and photographs have been included which makes possible the design of beams for the 6, 10, 11, 15, 20, and 40 meter bands.

July, 1956



YES HENRY HAS ALL THE NEW EQUIPMENT FIRST!

hallicrafters



NEW SX100

For top performance with extra pull power and ability to tune in stations.

\$29.50 Down  
20 monthly payments of \$14.65  
\$295.00 Cash Price

A few items in stock for immediate shipment are:

Model	Cash Down	20 Monthly Payments	CASH PRICE
S38D	5.00	2.47	\$ 49.95
S53A	9.00	4.45	89.95
S85	12.00	5.94	119.95
SX99	15.00	7.42	149.95
SX96	25.00	12.37	249.95
SX62A	35.00	17.32	349.95
R46B speaker			17.95
HT30	49.50	24.50	495.00
HT31	39.50	19.55	395.00
S94-S95	6.00	2.97	59.95
S-102	6.00	2.97	59.95
S-106	6.00	2.97	59.95

Write, wire, phone or visit either store today.

Butler 1, Missouri  
Phone 395

Bob Henry,  
W6ARA  
Butler, Mo.



Henry Radio Stores

Granite 7-6701

11240 West Olympic Blvd. Los Angeles 64

Ted Henry,  
W6OUU  
Los Angeles



"World's Largest Distributors of Short Wave Receivers."

TV TUNER REPAIRS  
PROMPT SERVICE

Defective tuners rebuilt to factory standards. New tuner guarantee. Ship prepaid.

RADIO PRODUCTS CO.

15-20 122nd Street • College Pt. 56, N. Y.  
We carry a full line of Replacement Tuners for all makes of T.V.

SCHEMATICS—CONVERSIONS  
FOR SURPLUS GEAR

NEW LIST DI! MANY ADDITIONS!

Send stamped, self addressed envelope for List D. Add 25c for chart explaining AN nomenclature. DO IT TODAY!

R. E. BOX 1220

GOODHEART BEVERLY HILLS, CAL.

LEARN TV

"At the most practical school in the west"

Work on late model sets—using modern equipment and service techniques: under qualified technician instructors. Short resident and correspondence courses—no unnecessary math or theory—also UHF and Color TV.

APPROVED FOR VETERANS . . . day and night classes.

Write for free literature, Dept. IA for residence—Dept. IAC for correspondence.

V.S.I. TELEVISION SCHOOL 4570 Firestone Blvd., Box 359  
South Gate, California

# Ask Yourself!

Do you use . . . make . . . or test anything in which electrons flow through wire?



**THEN YOU MUST BUY THIS**  
**2,000 OHM-PER-VOLT MULTI-TESTER**  
 Ready to use! Not a kit!  
**for only \$6.95**

Plus 50¢ for postage and handling. Remit \$7.45 with order. No C.O.D.  
**EVEN IF YOU ALREADY HAVE A MULTITESTER,** you also should get this inexpensive but accurate, rugged metal-cased tester—if only to use for rough and tumble work and checkink continuity!  
**HERE'S WHAT YOU GET:** Precision tester, 3 1/4" wide, 4 3/4" long and 1 1/2" thick. Scale width: 2 3/4". Fits the hand! Complete with penlight battery and test leads. 3% accuracy on voltage and current scales. AC or DC volts: 0-10, 0-50, 0-250, 0-500, 0-2,500. DC current: 0-500 microamperes, 0-50, 0-500, milliamperes. Resistance: 0-10,000 ohms, 0-1 megohm. DB: minus 20 to plus 22; plus 5 to plus 36. Well-damped D'Arsonval movement, with ohms adjust knob.  
**USE IT TO CHECK AC or DC voltages, broken wires, radio tube heaters, coils, resistors, capacitors, corrosion damage, etc.**

**FULL MONEY BACK GUARANTEE!**  
 WITH INSTRUCTIONS

## ASK FOR FREE FLYER! New, interesting bargains!

### THE BEST PORTABLE MOBILE 10 & 6!

The best for back-pack and automobile. 28-80 MC. AM. Modifications necessary for amateur use are easy and explicitly shown in simple instruction sheet furnished with your order. This is the famous Marine Corps' TBV. Original power supply not included, but power supply which you can use is spelled out in these instructions. Transceiver unit only, excellent, used condition. **\$14.95** with tubes. Special "tubes and accessories (antenna, mike, headset, and carrying bag). **\$24.95** all new. Only . . . . .

**FREQUENCY METER AND TEST OSCILLATOR!**  
 115 V., 50-8000 cy. power supply. In freq. meter section, crystal oscillator beats VFO. Osc. section goes out into or pulse modulated RF. With tubes, headset, cords, adapters, radiators, etc. and INSTRUCTION BOOK.  
 LU-2, 465-468.5 MC. Brand new. **\$19.95**  
 LU-1, 470-483.5 MC. Brand new **17.95**

All shpts. FOB wshs. Send 25% dep. with all COD orders. Item sub. to prior sale & change of price without notice. Min. order \$2.50.

## ARROW SALES, INC.

Western Mailing Address:  
 Box 3007-R, NORTH HOLLYWOOD, CALIF.  
 Central Mailing Address & Sales-Showroom:  
 2441 S. MICH. AV., Dept. R, CHICAGO 16, ILL.  
 California Distributors' Stores:  
 G. L. Electronics, Inc. 1632 Venice, Los Angeles  
 P.A.R.T.S., Inc., 2005 Empire Ave., Burbank

## L M B BOX CHASSIS OFFERS FREE inside LMB boxes

10 tested kit diagram projects for the builder. Each one of these kit diagrams built by a recognized expert. Kit projects are complete in every detail. Circuit diagram, photo of project both front and rear photo. Rear photo shows wiring and parts. Detailed instructions for building, complete parts list and approximate cost. Complete to build except parts and your distributor can supply the parts. Ask your distributor for the list of LMB Kit Diagram Projects. If he does not have them, write to

**L M B** 1011 Venice Blvd.  
 Los Angeles, 15, Calif.

## LEARN TV SERVICING UHF-COLOR-VHF

Master the latest, up-to-the-minute TV and Color TV developments.

You can Earn to \$5,000-\$10,000 a year in TV servicing after a few short months. Education or age is no barrier. Find out how you can EARN WHILE YOU LEARN in our big Shops and Laboratories. You work with the latest equipment. Waste no time with Non-Essentials, Math or Design Theory. Complete information in our new FREE booklet. Address Dept. 7-56-R. Approved for veterans. Free Placement Service.

**WESTERN TELEVISION INSTITUTE**  
 341 W. 18th St. Los Angeles, Calif.

Dept. 7-56-R  
 Mail me information about training.  
 Name \_\_\_\_\_  
 Address \_\_\_\_\_

Hams will find this little book an invaluable addition to their shack libraries.

\* \* \*

**"HOW TO SELECT AND USE YOUR TAPE RECORDER"** by David Mark. Published by John F. Rider Publisher, Inc., New York. 138 pages. Price \$2.95. Paper bound.

The "embarrassment of riches" that confronts the would-be buyer of a tape recorder has made the task so confusing to the average consumer that he is inclined to throw in his hand and buy a record player or borrow a tape recorder from his neighbor.

Recognizing the need for a "guide-book" to the realm of tape recording, the author has painstakingly compiled the answers to the questions most often asked by the average user. Since the author has correctly assumed that the market for such devices exceeds the technical background of most would-be users, the text has been prepared in non-technical language and at a level which anyone can understand.

A short preliminary chapter "introduces" the equipment and then the author discusses the operation of a tape recorder, how to make recordings, the applications of a tape recorder in the home, in business, and in the professions, and how to use a recorder for preserving especially enjoyable musical moments. The "directory" section on the selection of a tape recorder is a fairly comprehensive one and covers all types of units from small portable recorders to elaborate professional devices. Each commercial unit is illustrated and its special characteristics described—a boon to the average tape recorder fan.

\* \* \*

**"PROCEEDINGS WORLD SYMPOSIUM ON APPLIED SOLAR ENERGY."** Published by the Association for Applied Solar Energy, 204 Heard Building, Phoenix, Arizona. 330 pages. Price \$5.00.

This volume contains the full proceedings of the meeting on applied solar energy held last November in Phoenix, Arizona.

Papers by 30 internationally recognized authorities on solar energy utilization have been reprinted, along with photographs and drawings to illustrate the subject matter.

A summary of the round table discussion on "The Future of Applied Solar Energy" has also been included. Those interested in the subject will find this compilation helpful, enlightening, and an excellent springboard for additional study.

\* \* \*

**"MOST-OFTEN-NEEDED 1956 RADIO DIAGRAMS"** compiled by M. N. Beitman. Published by Supreme Publications, Highland Park, Illinois. 192 pages. Price \$2.50. Paper bound.

This is the sixteenth of the radio receiver volumes in this popular series for service technicians.

Like its predecessor volumes, each model is covered completely. The data

## NEW BE QUALITY WISE... BUY QUAL-KITS!

**Hi-Fi AM-FM Tuner**  
 Advanced 7 tube circuit provides full sensitivity and selectivity giving this AM-FM tuner exceptional hi-fi reception. Armstrong FM circuit with limiter, Foster-Seeley Discriminator. 20-20,000 cps response. Full AFC control—no drift.



**Hi-Fi Amp.**  
 Complete 6 tube-10 watt amplifier. Push-pull beam power output, built-in pre-amp. 5 position selector switch, 3 position record equalization, LP, RIAA, Eur. Response 1/2 db. 20-20,000 cps. Output 10 Watts at less than 2% IM. Low noise level and harmonic distortion.



\$28.95

\$28.50

Cover and lens optional. Every kit complete with 28 page fully illustrated, instruction and assembly manual. Write today for FREE catalogue and name of nearest dealer carrying these remarkable units.

**Quality-Electronics Dept. T-6**

319 Church Street New York 13, N. Y.

## MARINE DIRECTION FINDER Beacons, Broadcast and Boat Bands. Very Sensitive and Accurate. Brand New. . . . . Complete \$99.50

### 274N/ARC-5 TRANSMITTERS

7-9 mc. . . . . Brand New \$ 5.95  
 3-4 mc. . . . . Like New 4.95  
 4-5 mc. . . . . Like New 4.95  
 2-3 mc. . . . . Like New 4.95

### RECEIVERS

6-9 mc. . . . . Like New \$ 4.95  
 100-156 mc. . . . . 11.95  
 ARC-4 2-meter Transceiver . . . 24.50  
 ABQ 10CM Sig. Gen. 110 v. 60 cy. 19.50  
 TS-184A/AP 400-430 mc. Sig. Gen. . . . . New 49.50

Write for free catalog of many Bargains.  
 2049-Main COM-LAB San Diego, Calif.



## wanted career men

Train for a career instead of a job. Demand for our graduates exceeds supply. Effective placement. Modest costs. Small classes. Well-equipped labs. Beautiful campus. Approved for Vets. Enter Sept., Jan., March, June.

**Bach. Sci. degree in 27 months**  
 Complete Radio Eng. courses . . . TV, UHF, FM, Electronics. Also Mech., Civil, Elec., Chem., Aero. Eng. 36-month B.S. in Bus. Adm. (Gen. Bus., Acctg., Motor Transport Mgt.) . . . capable students faster. Prep courses. Write Jean McCarthy, Dir. Adm., for catalog and "Your Career in Engineering & Commerce."



## TRI-STATE COLLEGE

1676 College Avenue, Angola, Indiana



**AMERICAN CANCER SOCIETY**

about each set includes a schematic, alignment data, voltage and resistance readings, dial cord data (where it applies), alignment procedure, and special hints on servicing unusual circuitry.

Receivers manufactured by some thirty-five companies have been included. Service technicians will find this up-to-date material helpful in cutting troubleshooting time and speeding servicing. —30—

### PHOTO CREDITS

Page	Credit
35, 49, 98	Admiral Corporation
36 (Fig. 2), 37 (Fig. 7, right)	Setchell Carlson
36 (Figs. 3 & 5), 37 (Fig. 6 & Fig. 7, left), 42 (top & left center), 128 (Fig. 9), 129	Radio Corporation of America
37 (Fig. 7, center), 40, 41, 42 (top left), 128 (Fig. 8)	General Electric Company
38, 39, 120	Joseph Steinmetz
42 (bottom left)	Sylvania Electric Products Inc.
50 (left), 50 (center)	Arvin Industries
50 (right)	Allen B. Du Mont Laboratories, Inc.
56, 57	Crosley Division
62, 63	Barker & Williamson
64, 65	Philco Corporation
67	Electronic Instrument Company
86	Precision Apparatus Company, Inc.
88	Emerson Radio & Phonograph Corp.
92	The Heath Company
104	Ampex Corporation
117	Signal Corps Engineering Laboratories, Fort Monmouth, New Jersey
	Raytheon Manufacturing Company

### ERRATA

On page 96 of the March, 1956 issue, in "New Tube Tester Data," the settings for the Type 1629 tube listed for the Supreme Models 600 & 616 should read 90D2978 instead of 90D2778 as indicated. In other words, the fifth item should be a "9," not a "7".

The equation for the admittance of a parallel resonant circuit, given on page 62 of the February, 1956 issue ("Frequency Control Through Variable Resistance") should read as follows:

$$Y_t = j\omega C + \frac{1}{j\omega L} + \frac{j\omega C_1}{1 + jR\omega C}$$

The error in the equation given in the text does not affect the values in the remainder of the article.

The principle of operation of the auto radio search tuner discussed in the March, 1956 issue (pages 48 and 164) is as follows rather than as was described in the article. The i.f. signal voltage at the second i.f. transformer secondary is coupled to the grid of the first section of the 12AU7 trigger tube, operating as a detector-amplifier. This signal causes the detector-amplifier to conduct sufficiently to drive the second section of the 12AU7 into cut-off, thereby de-energizing the relay, and stopping the sweeping or search action of the tuner. Negative a.v.c. signal is also applied to the grid of the detector-amplifier, but its purpose is to act only as a delay in stopping on certain signals, so that the tuner does not stop on the sideband of strong stations. Because of the above, a negative trigger voltage on the grid of the detector-amplifier will not stop the tuner sweeping action.

Also, when the actuator switch is first depressed, both cathodes are placed nearer ground potential (less positive voltage). At this time the detector-amplifier does not conduct but the relay section of the 12AU7 conducts and holds the relay energized. This allows the tuner to search or sweep. The detector-amplifier conducts only when a signal is applied to its grid.

A precautionary statement should have been included where the recommendation was made to check the mechanical system for binds by pulling the relay stop or armature out of the paddle wheel and then applying power and seeing if the sweep operates and returns properly. Extreme care should be exercised in this test so as not to damage the relay contacts. The relay arm must be pulled very gently to prevent bending these contacts.

## ELECTRONICS TECHNICIANS

### SR. LAB TECHNICIANS

Excellent opportunities and employee benefits at

## SPERRY

a company with an enviable record of 44 years' growth and expansion.

**ELECTRONICS TECHNICIANS** Minimum 5 years' experience on construction of complex electronic equipment. Knowledge of pulse, radio, electronic and audio frequency circuits: ability to use common electronic test equipment required. Minimum 2 years' engineering school or equivalent training.

**SR LAB TECHNICIAN** 10 to 15 years exp. in the design, construction and maintenance of complicated electronic equipment.

### LIBERAL COMPANY BENEFITS

Over 1,500 employees have been with Sperry more than 15 years ... ample evidence of opportunity, excellent benefits and fine working conditions.

PLEASE SUBMIT RESUME  
to

Mr. E. Williams

Interviews may be arranged  
locally or at plant at  
company expense.

# SPERRY

GYROSCOPE COMPANY

DIVISION OF SPERRY RAND CORP.  
Marcus Ave. & Lakeville Rd.  
Great Neck, L. I., N. Y.

~~384,000~~ ~~650,000~~ **767,000\***

## MOBILE-RADIO RIGS NEED MAINTENANCE

You can have a specialized, high-paying business in this fast-growing field—on contract terms! Send for booklet "HOW TO MAKE MONEY IN MOBILE-RADIO MAINTENANCE".

LAMPKIN METERS are the preferred test equipment!

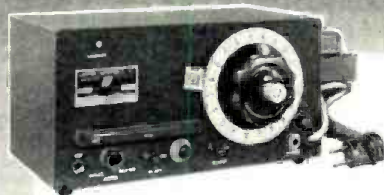

**LAMPKIN 105-B MICROMETER FREQUENCY METER**

Heterodyne type. Range 0.1 to 175 MC. (crystal-controlled transmitters to 500 MC.), all channels. Pinpoint VHF CW signal source. Weight 13 lbs. Width 13". Price \$220.00 net.

\*Annual FCC figures for last three years!

MAIL  
COUPON  
TODAY!



**LAMPKIN 205-A FM MODULATION METER**

Indicates FM voice deviation, ± 25 KC. Tunes 25-500 MC. in one band. Has speaker, oscilloscope output. Easy to carry. Weight 13 lbs. Width 12". Price \$240.00 net.

LAMPKIN LABORATORIES, INC.  
MFM Division, Bradenton, Florida  
At no obligation to me, please send  
 Free booklet  Data on Lampkin meters  
Name \_\_\_\_\_  
Address \_\_\_\_\_  
City \_\_\_\_\_ State \_\_\_\_\_

**LAMPKIN LABORATORIES, INC.**

MFM Division  
BRADENTON, FLORIDA

WRITE FOR BONUS BARGAIN CATALOG

**"TABLITE" ELECTRONIC FLASH KITS**

AC & Battery Inbuilt  
All in One Camera Case



Uses new low cost voltage super circuit constant bright light output: light duration 1/600 sec.; color K 6800°; cost per flash less than 3¢. 1000 to 2000 flashes per set of batteries. All kits with inbuilt AC Pack. (Kits less batteries.)  
MODEL 400V, 60W sec'd color 75+; 8 & W 225+; Recycles 2 sec'd, less than 4 lbs.; \$29.95  
MODEL 600V, 120W sec'd color 100+; 8 & W 300+; Recycles 5 sec'd, less than 5 lbs.; \$44.95  
2-240V Batteries. \$10  
**SOLD WITH "TAB" MONEY BACK GUARANTEE**  
Photoflash Cond. 525MFD/450V/53W SEC. NEW LOW leakage, Famous mfr. @ \$8: 2/515

**INFRARED SNOOPERSCOPE**



See In Dark Tube  
Selected G.T.D. Image Converter Tube. H-sensitivity amplified design 2" dia. Wilomitic screen. Hi Resolution. Tube & Data. Special @ \$3.90; 2/5750

**Snooperscope Power Supply**  
Model PS2001-4500VDC/35MA, Using Dual Doubler Ckt. In Metal Cabinet. \$21.95  
KIT, Same as above, Less Cabinet. \$13.95

**TUBES WARRANTY**

No Electrical or Mechanical Rejects

024	.45 6AV5	.80 6K6	.45 12AX7	.55
1AX2	.45 6AV5	.80 6K6	.45 12AX7	.55
1B3	.65 6AX4	.80 6SA7	.50 12BE6	.65
1R5	.50 6AX5	.75 6S7	.65 12BH7	.65
1T4	.50 6AG4	.40 6X4	.50 12C7	.97
1U5	.45 6BC5	.60 6SL7	.55 12SA7	.64
1X2	.85 6BE6	.45 6SN7	.55 12SK7	.45
3V4	.75 6CG6	1.24 6X4	.55 12X7	.56
5U4	.45 6BK7A	1.11 6T4	1.15 12SQ7	.50
5V4	1.28 6BL7	.90 6T8	.75 25BQ6	.90
5Y3	.65 6BW6	1.19 6X4	.50 25C4	.90
6AC7	.65 6BQ6	.90 6W4	.35 25W4	1.03
6AG5	.45 6BQ7A	1.30 6X4	.40 35L6	.69
6AK5	.60 6A4	.30 6X5	.45 35W4	.50
6AR5	.65 6CB6	.50 6X4	.40 50L6	.45
6AQ5	.45 6CD6	1.08 12AT6	.40 50R5	.70
6AT6	.40 6CF6	1.25 12AT7	.65 50C5	.52
6AU4	.95 6AU6	1.65 12AU6	.40 50L6	.55
6AU5	1.10 6J5	.40 12AU7	.50 75	.85
6AU6	.45 6J6	.45 12AX4	1.29 83V	1.22

**VARIABLE 0 TO 6 & 12 VOLT/12 AMP DC Power Supply**

Battery Eliminator, Charger, Model RR. Plater, Aircraft, Marine or any DC reg. Extra hvy duty Selenium Rectifier, 2 meters V & A. Designed for continuous service & up to 20 Amps intermittent overload.  
MODEL T612V12AC. @ \$33.00



**"TABTRON" HI CURRENT PWR SUPPLIES ONE YEAR GUARANTEE**

Variable 0-28VDC. Completely Built. Incls: Full Wave Selenium Rectifier, Transformer, Varicac, Volt & Amp Meters, Switch, Terminals & Fuse. In Hvy duty Steel Cabinet. Standard 115V/60cy input or 220V and 3 Phase to order. SPECIFY.

Sk. No.	Cont. Rating	W-Meters
T28V5A	0-28 VDC at 5 Amp	\$125.00
T28V12A	0-28 VDC at 12 Amp	\$125.00
T28V24A†	0-28 VDC at 24 Amp	\$155.00
T28V50A†	0-28 VDC at 50 Amp	\$285.00

WRITE FOR COMPLETE LIST

**NEW "TABTRON" SELENIUM BRIDGE Gtd. RECTIFIERS One Yr. FOLLOWING LIST, FULL WAVE BRIDGE**

Curr.	18/14	36/24	52/32	130/100
Cont. Volts	Volts	Volts	Volts	Volts
1AMP	\$1.40	\$2.80	\$3.70	\$7.40
2AMP	2.00	3.40	3.30	10.25
3AMP	2.90	4.10	5.75	12.70
4AMP	3.50	6.40	11.25	25.00
6AMP	5.95	7.70	12.75	28.50
10AMP	5.85	11.35	19.40	41.25
12AMP	7.20	14.25	22.00	43.85

**KITS! KITS!**

Thousands of Satisfied Customers  
All Kits Contain Most Popular Values & Sizes

10 Volume Controls	10 Rotary Switches
50 Terminal Strips	10 Pilot Lamps
15 Wirewound Resistors	10 Toggle Switches
50 Paper Condensers	25 1% Resistors
10 Condensers, Bathtubs	25 Tube Sockets
25 Inductors & Coils	5 Crystal Diodes
50 Carbon Resistors	

\*In Plastic Box  
EACH KIT ONLY **95c**

**FAMOUS BRAND PHONO CARTRIDGES**

Original Boxed, Money Back Gtd.  
RPX050A .001 & .003 (SS) \$6.75  
RPX052A Golden Treasure (DS) \$19.25  
RPX053A Golden Treasure (DD) \$28.00

**Replacement Needles "TETRAD" Diamond†**  
RPJ01A Dual (DS) .001 & .003 "TETRAD" \$11.10  
RPJ01D or RPJ03D Single (D) "TETRAD" \$9.55  
RPJ01S or RPJ03S Single (S) "TETRAD" \$1.35  
RPJ003 or RPJ004 Single (D) "TETRAD" \$9.85  
MG or 78 Single (D) "TETRAD" \$9.89

**NEW COLLARO RC-54 RECORD CHANGER @ \$27.95; With RPX050A @ \$34.90; With RPX052A @ \$44.95**

**FINEST HI-FI RECORDING TAPE 1200 Ft.—7" Reel \$1.45 Lots Money Back Gtd. \$1.45 of 12**

Precision Coated & Silt Gtd. Splice Free. Quality Controlled. Plast. Base. Gtd. Constant Output, Freq. 71 IPS. 40-15K.C. Oxide Wnd In. @ \$1.39 ea. 3 for \$1.50 ea.

**NEW IMPROVED "TAB" HI-FI SPEAKERS**

With Inbuilt Network Ticonal Alnico 5 Plus Magnet. 4 to 8 Ohms V.C.  
15" TRIAX 25 Watt/20-20,000 Cycles. MODEL F15H3X \$36  
12" TRIAX 25 Watt/40-20,000 Cycles. MODEL F12H3X \$27  
8" COAX. 6 to 10 Watt/75-19,000 Cycles. MODEL FBH2X \$8

**"TAB"** TERMS: Money Back Gtd (cost of mfg. only) 55 min order F.O.B. N.Y.C. Add ship charges or for C.O.D. 25% Dep. Tubes etc. via Reg. Only. Prices shown subject to change. DEPT. 7RNG, 111 LIBERTY ST., N.Y.C. PHONE RECORDER 2-6245-CABLE "TABPARTS"

**INDEX OF Advertisers**

JULY 1956

[While every precaution is taken to insure accuracy, we cannot guarantee against the possibility of an occasional change or omission in the preparation of this index.]

ADVERTISER	PAGE	ADVERTISER	PAGE
Aero Products Co.	102	McGee Radio Company	96, 97
Aermotor Company	121	M. R. Company, The	131
Airex Radio Corp.	133	Major Brand Tube Co.	93
Allied Radio Corp.	9, 87	Mallory & Co., Inc., P. R.	71, Fourth Cover
Altec Lansing Corporation	6	Merit Coil & Transformer Corp.	14
American Television & Radio Co.	92	Miami Instrument Company	123
Arnold Ceramics, Inc.	122	Milwaukee School of Engineering	99
Arrow Sales, Inc.	142	Moss Electronic Distributing Co., Inc.	90, 91
Ashe Radio Company, Walter	85	Musical Masterpiece Society, The	139
Audel Publishers	126		
		National Radio Institute	7, 3
Baltimore Technical Institute	140	National Schools	25
Barry Electronics Corp.	145	Newark Surplus Materials Co.	131
Bendix Radio	127	North American Phillips Co., Inc.	26
Blonder-Tongue Laboratories, Inc.	94		
		Pacific States University	134
CBS-Hytron	29	Peak Electronics Company	124
C & H Sales Co.	134	Phoastron Instrument and Electronic Company	135
Candler System Co.	125	Philco Techrep Division	103
Capital Electronics	132	Precise Development Corp.	123
Capitol Radio Engineering Institute	21	Prentice-Hall, Inc.	119
Centralab	20	Presto Recording Corporation	129
Cleveland Institute of Radio Electronics	11	Progressive "Edu-Kits", Inc.	128
Columbia Electronics	127		
Com. Lab.	142	Quality Electronics	142
Coyne Electrical School	100, 121		
		R.C.A. Institutes, Inc.	15, 132
DeVry Technical Institute	5	RW Electronics	136
Dressner	125	Radiart Corporation, The	10
Dyna Company	108	Radio Corporation of America	22, 24
		Radio Ham Shack, Inc.	146
Editors and Engineers, Ltd.	127	Radio Kits, Inc.	137
Electronic Chemical Corp.	133	Radionic Prod. Co.	140
Electronic Instrument Co., Inc. (EICO)	33, 34	Radio Products Co.	141
Electro-Voice	8, 17	Radio-Television Training Association	23
E-Z Way Towers, Inc.	118	Rad-Tel Tube Co.	100
		Raytheon Manufacturing Company	Second Cover
Fair Radio Sales	113	Rek-O-Kut Company	110
Fisher Radio Corp.	16, 18, 31, 104	Rex Radio Supply	126
		Rinehart & Co., Inc.	114, 129
G & G Radio Supply Co.	81	Rockbar Corporation	82
General Electric	12, 13		
Goodheart, R. E.	141	Sams & Co., Inc., Howard W.	32, 83
Granco Products, Inc.	84	Sandia Corporation	103
Greenlee Tool Co.	118	Semler Industries, Inc.	132
		Soundmart Unlimited	129
Hallcrafters	19	Sperry Gyroscope Company	143
Hartley Products Co.	112	Sports Cars Illustrated	139
Harvey Radio Co., Inc.	125	Sprague Products Company	126
Heath Company	72, 73, 74, 75, 76, 77, 78, 79	Stan-Burn Radio & Electronics Co.	134
Henry Radio Stores	141	Stanley Electronics Corp.	115
Hershel Radio Co.	138	Stevens Walden, Inc.	137
Hickok Electrical Instrument Company, The	132	Supreme Publications	109
Hycon Electronics, Inc.	28	Sylvania Electric Products, Inc.	27
		"TAB"	144
Indiana Technical College	132	Telemarine Communications Co.	89
Instructograph Company	123	Texas Crystals	132
International Business Machines Corporation	101	Triplett Electrical Instrument Corp.	Third Cover
International Radio & Electronics Corp.	131	Tri-State College	142
		Tube Mart	84
J. J. Glass Electronics Co.	138	Tung-Sol Electric, Inc.	117
Jackson Electrical Instrument Co.	120	TV Remote Control Co.	116
Johnson Company, E. F.	140		
		United Catalog Publishers, Inc.	30
Kaar Engineering Corp.	121, 132	U. S. Crystals, Inc.	134
Kuhn Electronics	114		
		V.S.I. Television School	141
LMB Box Chassis	142	Valparaiso Technical Institute	125
Lafayette Radio	69	Video Electric Company	111
Lampe, E.	134		
Lampkin Laboratories, Inc.	143	Western Television Institute	142
Lektron Specialties	130	Windsor International Co., Inc.	140
		World Radio Laboratories, Inc.	86



# Classified

RATE: 50¢ per word. Minimum 10 words. September issue closes July 10th.  
Send order and remittance to: RADIO & TELEVISION NEWS, 366 Madison Ave., N. Y. C. 17.

## RADIO ENGINEERING

COMPLETE radio, electronics theory & practice; television; broadcasting; servicing; aviation, marine, police radio, 18 or 21 months. Catalog, Valparaiso Technical Institute, Dept. N, Valparaiso, Ind.

## FOR SALE

DIAGRAMS for repairing radios \$1.00. Television \$2.00. Give make, model. Diagram Service, Box 672-RN, Hartford 1, Conn.

TV Trade-In sets. Philco, R.C.A., Emerson, others. List available. 10"-\$12. 12" to 17"-\$15. up. Washtek Service Co., Dept. R, 956 Southern Blvd., Bronx, N. Y.

TUBES—TV, Radio, Transmitting And Industrial Types At Sensibly Low Prices. New, Guaranteed, 1st Quality, Top Name Brands Only. Write For Free Catalog or Call Walker 5-7000, Barry Electronics Corp., 512 Broadway, New York 12N, N. Y.

TRADE-IN Television Sets \$14. Jones Radio, 1115 Ramlmer, Pottstown, Pa.

DIAGRAMS—Radios, Amplifiers, Chargers. \$1.00 Each. Television Service Data \$2.00. Unknown Models, Give Tube Layout And Part Numbers. Kramer's Radio Service, Dept. 656, 36 Columbus Ave., New York 23, N. Y.

GEIGERS & Scintillators, Free Catalog. E.A.K. Research Labs, Tarrytown, N. Y.

NORELCO-PHILIPS, Amperex, and Foreign—Radio, TV, and Special Purpose Tubes! Norelco electric shavers! Wholesale and retail! Write—TV Millie, Box 101-AJ, Hicksville, New York.

TECHNICIANS, Novices: 6 meter 5-element beam antenna, \$14.95 ppd. 2 meter 6-element, \$6.95 ppd. Wholesale Supply Co., Lunenburg, Mass.

RECEIVERS R25/ARC-5 1.5-3MC Brand New With Tubes/Dynamotor Spined Knob-Conversion Manual \$6.95 FOB—Earl Hoey, Hayward Airport, Hayward, California.

DIAGRAMS—Repair Information! Radios, Amplifiers, Recorders \$1.00. Television \$1.50. Send Make, Model, Chassis. (Air-Mail? +20¢.) TV Millie, Box 101, Hicksville, New York.

BUY Surplus Electronics; Instruments; Test Equipment; Sonar; Radar; Tubes; Transceivers—Direct From U. S. Government Surplus Depots—List & Procedure \$1.00—Brody, Box 8-RTA, Sunnyside 4, New York.

COLLECTOR'S Item. Immaculate Atwater Kent Model Forty with speaker. All parts original. Make offer. L. O'Sullivan, P. O. Box 861, San Luis Obispo, Calif.

SOUND Mart For All Your Hi-Fi Requirements: Amplifiers, Tuners, Turntables, Speakers—Full Line—Shipments Prepaid And Insured—Write For Free Bulletin—Sound Mart Unlimited, 63-03 39th Avenue, Woodside 77, New York.

## WANTED

HIGHEST prices paid for Surplus Radios—RT18/ARC1—ART 13—R5/ARN7—BC 788C—BC342 Etc. Write W2KI'W, 308 Hickory, Arlington, N. J.

CYLINDER and old disc phonographs. Edison Concert, Balmoral, Conqueror, Opera, and Oratorio models. Berliner Gramophones and Zono-ophones, Columbia disc and cylinder Graphophones, Bettini micro-reproducer. Want old catalogues and literature on early phones prior to 1919. Will pay cash or trade late hi-fi components. Box 50 % RADIO & TELEVISION NEWS.

AN/APR-4, AN/APR-9, other "APR-," "ARR-," "TS-," ARC-1, ARC-3, ART-13, everything surplus: Tubes, Manuals, Laboratory equipment. Describe, price in first letter. Engineering Associates, 434 Patterson Rd., Dayton 9, Ohio.

TUBES and equipment bought, sold, and exchanged. For action and a fair deal write B. F. Gensler, W2LN1, 56 Crosby St., N. Y. 12N, N. Y.

ART-13/T47A Transmitters, \$175.00; ART-13/T47 Transmitters, \$125.00; BC-788 C Altimeters, \$175.00; ARC-3 Transceiver Complete, \$325.00; R5/ARN-7 Radio Compass, \$175.00; BC-348 Rec'r Modified, \$25.00; BC-348 Rec'r Unmodified, \$50.00; ARC-1 Transceiver, \$300.00; BC-342 Rec'r, \$50.00; BC-312 Rec'r, \$40.00; I-152-C Indicator, \$50.00. Ship Via Express, C.O.D. Subject To Inspection To H. Finnegan, 49 Washington Ave., Little Ferry, N. J.

WANTED: Receiver R5/ARN-7, MN-62A Transceivers, RT18/ARC-1, AN/ARC-3, BC-788C, I-152C, Collins, Bendix equipment, Test Sets, Dynamotors, Inverters. We pay highest prices. Advise quantity, condition, price first letter. Aircraft Radio Industries, Inc., 15 East 40th St., New York City, telephone LEXington 2-6254.

WANTED—All types of Electronic Tubes: broadcast (water and air cooled), transmitting, receiving, Magnetrons, Klystrons, also all kinds of airborne equipment: ADF-70; ARC-1, -3, -4, -12, -15, -27, -33; ARN-6, -7, -12, -14, -18; BC-312, -342, -610E, -788C, -2121; I-152; ID-48; MN-24C, -31C, -36, -42, -53, -58, -61, -85, -97F, -100A; RA-18; TA-18; 17-L3; 51-R, -R3; 51-V1, Etc. Top Dollar Paid. Write to Bob Sannet, W6REX, 1524 S. Edris Dr., Los Angeles 35, Calif.

WANTED: ART-13 transmitters and parts—also ARC-1, ARC-3 and ARN-7. Have requirement for ARN-6 material. Iron Core Loops, need all types Collins and Bendix Aircraft Radio equipment. Florida Aircraft Radio & Marine, Inc. P. O. Box 205, International Airport Branch, Miami 48, Florida.

## REPAIRS AND SERVICING

HIGH Fidelity Speakers Renalred. Amprite Speaker Service, 70 Vesey St., N. Y. 7, N. Y. Ba. 7-2580.

## TAPE RECORDERS

PRE-recorded Tape Music, recording tape accessories, Discounts. Catalogue. Efsco Sales, 270 E. Concord, West Hempstead, N. Y.

TAPE Recorders, Tape, Unusual Values. Free catalogue. Dressner 69-02 R, 174 St., Flushing 65, N. Y.

## BUSINESS OPPORTUNITIES

MAKE \$25. per day full or part time. Buy tools wholesale. Discounts to 50%. Send \$1.00 for glant 1956 catalogue, and dealers card. \$1.00 refunded with first purchase. Bargain Tool Company, Box 551 % RADIO & TELEVISION NEWS.

## CORRESPONDENCE COURSES

USED Correspondence Courses and Books sold and rented. Money back guarantee. Catalog free. (Courses bought.) Lee Mountain, Pisgah, Ala.

USED Correspondence Courses and Books Bought, Sold, Rented, Catalog Free. Myrtle Vernon, Henagar, Ala.

Only the 5 TOP QUALITY brands of

# STANDARD BRAND TUBES

AT SENSIBLE PRICES!

- Individually boxed • First quality only
- Brand New • 90-Day RETMA guarantee
- No private brands • No rejects
- No rebrands or rewashed bargains

**Free!** Newest handy air-mail order form for your ordering convenience. Lists over 400 popular replacement types.  
**WRITE FOR YOUR FREE COPY TODAY!**

- Lists ALL popular TV & radio types.
- Makes mail-ordering a real pleasure.
- All tube orders over \$25.00 (with remittance) postpaid.

## SPECIAL-PURPOSE TUBES

Write for our complete listing on Transmitting, Industrial, Special-Purpose Tubes, and Crystal Diodes. We STOCK over 1000 types at excellent prices.

## TRANSMITTING TUBE SPECIALS

(SURPLUS-NEW ORIG. BOXED)

4PR60A	.....\$50.00	750TL	.....\$50.00
304TH	..... 8.75	803	..... 2.00
307	..... 6.00	607W/5933	..... 2.85
450TH	..... 47.50	872A	..... 1.25

## EQUIPMENT SPECIALS!

LM-15 NAVY FREQ. METER W/orig. book, XTAL & Power Supply. Exc. .... \$150.00  
LM POWER SUPPLY, Exc. Cond. .... 35.00  
KAY MEGA-MARKER SR., 13 channel xtal freq. TV-marker, vy gd. .... 49.50

## TUBE CHECKER SPECIALS!

HICKOK mutual cond. type., model I-177, in metal case, w/tube data & inst. books. Used—Good ..... \$35.00  
HICKOK combo. CHECKER/ANALYZER model 550K mut. cond. type. Used, cases worn, but in good oper. condx. W/latest tube data book. Special ..... 39.50  
PRECISION MODEL 912 portable. Used, in good oper. condx. W/instr. book & role chart ..... 33.50  
PRECISION CHECKER/ANALYZER MODEL 920 used, worn, but in good oper. condx. W/instr. book & role chart. Special ..... 37.50  
BRAND NEW PRECISION MODEL 10-12 portable, latest type. (Worth \$110.00) Our price, only ..... 89.00

## 2 COLOR TUBE CARTONS

Keeps your tube stock neat. New safety partition prevents tube breakage. Distinctively lithographed in glossy red and black. The most distinctive tube carton available today. Minimum quantity: 100 of any one size. Write for case lot prices.

SIZE	FOR TUBE	PER 100
Miniature	..... 6AU6, etc.	..... \$1.00
GT	..... 6SN7, etc.	..... 1.25
Large GT	..... 1B3, etc.	..... 1.50
Large G	..... 5U4G, etc.	..... 2.00

Completely blank. No printing. Color. Otherwise same as above. Same high quality, same low prices. Specify "white" when ordering.

## TUBE STACKERS

White glossy only. Ministacker holds 10 Mini. tube cartons; "GT" stacker holds 10 "GT" cartons.

SIZE	PER 100
Ministacker	..... \$1.50
GT	..... 2.00

## DIRECTRON SELENIUM RECTIFIERS

Full Wave Bridge Type

Max. Amps.	18 VAC 14 VDC	28 VDC	24 VAC 22 VDC	72 VAC 60 VDC	130 VAC 100 VDC
1	\$1.35	\$2.30	\$3.70	\$4.50	\$7.40
2	2.00	2.75	5.30	5.90	9.15
2 1/2	2.90	4.10	5.75	7.85	12.70
3	4.00	6.40	11.25	14.35	21.70
6	3.95	7.70	12.75	17.30	29.65
10	5.65	11.35	19.40	24.80	41.25
15	7.20	14.25	22.05	29.75	45.85
20	13.05	25.05	37.25	48.75	78.50
24	14.25	28.75	44.50	57.65	81.00

We build other selenium rectifiers. Transformers and chokes to your specifications. Complete line of new rectifier transformers, chokes and filter capacitors in stock at all times. May be ordered at same time as selenium rectifiers above for immediate delivery. Write for complete price list.

## FILAMENT TRANSFORMER SPECIALS

Super Electric #229600.12  
Sec. 5 VCT @ 3 A; 5 VCT @ 3 A; 5 VCT @ 6 A.  
Pri. 220 volts, 60 cycles. **\$3.95**

Kenyon #S-10684  
Sec. 5 VCT @ 10 A.  
Pri. 210-220-230-240 volts, 60 cy. **\$4.95**

Collins #872-1141-00 (mfg by Chi., herm. sealed)  
Sec. 2.5 VCT @ 15 A.  
Pri. 210-220-230-240-250 volts, 60 cy. **\$4.95**

WRITE FOR "BARRY'S GREEN SHEET" ISSUED MONTHLY. FREE!

TERMS: 25% deposit with order, balance C.O.D. All merchandise guaranteed, F.O.B. N.Y.C.

**BARRY ELECTRONICS CORP.**

512 Broadway, Dept. RN, N.Y. 12, N.Y.

Call Day or Night—24 Hour Phone Service

Phone: WALKER 5-7000

When you order by mail . . .

please print your name and address clearly, be specific in your order, enclose proper amount, allow ample time for delivery.

**CASH for YOU!**

We urgently need for government contracts military electronic equipment, such as BC312, BC342, BC348, ART13, APR4, ARC1, ARC3, ARN6, ARN7, BC221, BC788, BC610, and many others. State conditions, type and best price.

# SENSATIONNEL!

We have in stock at all times over 2,000 different types of tubes. All first quality, money-back guarantee, individually boxed. Your best buy is Radio Ham Shack!

**QUICK SERVICE • HIGH QUALITY • LOW PRICES**

**TRANSmitters AND RECEIvERS**

APN-1	Altimeter aircraft	195-9050 KC
ARB	Receiver aircraft	100-156 MC
ARC-1	Tranceiver aircraft	100-156 MC
ARC-3	Tranceiver aircraft	140-144 MC
ARC-4	Tranceiver aircraft	LF-MF-HF-VHF
ARC-5	Xmitter and receiver	
ARN-1	Altimeter, aircraft	
ARN-3	Glide path receiver	332.6-335 MC
ARN-6	Radio compass airborne	100-1750 KC
ARN-7	Radio compass aircraft	100-1750 KC
ARR-2	Receiver, aircraft	234-258 MC
ARR-3	Sanobuoy receiver	60-72 KC-FM-
ART-13	Transmitter	200 KC-18 MC
BC-191	Transmitter	200 KC-12.5 MC
BC-223	Transmitter, marine	2-5.2 MC
BC-312	Receiver	1.7-18 MC
BC-342	Receiver	1.2-18 MC
BC-348	Receiver	200 KC-18 MC
BC-375	Transmitter	200 KC-18 MC
BC-645	Tranceiver	420-500 MC
BC-611	Handy talky	3-6 MC
BC-610	Transmitter	2-18 MC
BC-639	Receiver	100-156 MC
BC-640	Transmitter	100-158 MC
BC-1023	Marker Beacon receiver	75 MC
BC-1206	Beacon receiver	195-420 KC
CRC-7	Handy talky	140.58 MC
CRT-3	Xmitter, emergency	500 KC-8280 KC
DAB	Direction finder ground	2-18.1 MC
DAK	Direction finder marine	250-1500 KC
DAV-2	Tranceiver/direct. finder	2.3-4.5 MC
ET4336	Transmitter	2-20 MC
FRC-1	Tranceiver	1.5-12.5 MC
GRC-9	Tranceiver	
GN-26	Radio compass	150 KC-12 MC
PPN-1	Beacon transcvr ground	214-234 MC
RAIODB	Compass receiver	150 KC-10 MC
RAK-7	Receiver	15-600 KC
RAV-7	Receiver	3-23 MC
RBZ	Receiver, portable	2-5.8 MC
RC-103	Recvr, glide path	108.3-110.3 MC
RC-192	IFF systems	160-186 MC
SCR-269G	Radio compass	200-1750 KC
SCR-274N	Airborne command sets	LF-MF-HF-VHF
SCR-284	Rec/xmitter, mobile	3.8-5.8 MC
SCR-291	Radio direction finder	1.5-30 MC
SCR-300	Tranceiver, portable	40-48 MC FM
SCR-303	Radio direction finder	100-3000 KC
SCR-306	Receiver/transmitter	2-6 MC
SCR-308	Recr/xmitter, mobile	20-27.9 MC FM
SCR-309	Tranceiver	20-27.9 MC FM
SCR-310	Tranceiver, mobile	20-27.9 MC FM
SCR-311	Tranceiver, portable	2-6 MC
SCR-322	Tranceiver, mobile	100-156 MC
SCR-336	Handy talky	3-6 MC
SCR-343	Tranceiver, mobile	168-445 MC
SCR-355	Radio direction finder	18-65 MC
SCR-378	Transmitter	500 KC
SCR-608	Receiver/transmitter	27-38.9 MC FM
SCR-609	Tranceiver	27-38.9 MC FM
SCR-610	Tranceiver	27-38.9 MC FM
SCR-625	Part. metal detector	
SCR-694	Tranceiver	3.8-6.5 MC
SCR-718	Altimeter, high alt.	0-40,000 FT
TBY	Transmitter, portable	28-80 MC
TCS	Receiver/transmitter	1.5-12 MC
TRC-1-3-4	Radio relay station	70-99.9 MC FM
TRC-8-11-12	Radio relay station	230-250 MC FM
TRC-10	Tranceiver, portable	2-12 MC
VRC-3	Tranceiver	40-48 MC FM
19 MK-2	Tranceiver	230-240 MC 2-8 MC
27AA	Transmitter	300-500 KC 2-15 MC

**VALVES**

INDUSTRIAL AND MILITARY TYPES				
Receiving	Transmitting	Klystrons	Magnetrans	
Thyratrons	Cathode Ray	Microphones	Keys	
		Voltage Regulators		
		Crystal Rectifiers		
		Gas Switching		
		Phototubes		
		Ignitators		
		Transistors		
		Headsets		
BMC-1	MASK	J-37	H-16U	HI IMP.
T-17	HAND	J-38	HS-23	HI IMP.
T-30	THROAT	J-45	HS-30	LOW IMP.
T-32	DESK	J-47	HS-33	LOW IMP.
T-45	TYPE	J-48	HS-38	LOW IMP.

MANY OTHERS AVAILABLE FROM STOCK. Over one million tubes of all types in stock. Your inquiries will be promptly answered.

**TUBES! First Quality—Fully Guaranteed—Standard Brands—No Seconds TUBES!**

RECEIVING TUBES						TRANSMITTING AND SPECIAL PURPOSE TUBES					
OZ4	.49	6B4G	.95	7B5	.65	OA3/VR75	.86	250TH	18.95	959	1.32
1A3	.68	6B8	.67	7B6	.75	OB3/VR90	.73	250TL	14.75	991	.29
1A7GT	.32	6BA6	.63	7B7	.75	OC3/VR105.68	274A	1.40	1603	2.95	
1A4	.92	6BC5	.68	7C5	.75	OD3/VR150.68	274B	.85	1616	.50	
1A2	.95	6BE6	.65	7C6	.75	1B22	1.25	304TH	7.95	1619	.30
1B3GT	.79	6BF6	.68	7C7	.79	1B23	2.68	304TL	9.95	1622	1.45
1C5GT	.55	6BG6G	1.75	7F7	.85	1B24	4.85	307A	1.10	1624	.95
1G6GT	.65	6BH6	.79	7F8	1.10	1B27	12.95	350A	2.65	1625	.29
1G6GT	.49	6BJ6	.69	7N7	.85	1B35	3.45	350B	2.35	1626	.19
1H5GT	.58	6BK7	1.05	7R7	.95	1B38	33.50	371B	.85	1633	.85
1J6GT	.69	6BL7GT	1.05	7V7	.95	1N21	.39	393A	4.50	1635	1.48
1L4	.74	6BN6	1.10	7Y4	.65	1N21B	1.45	WL41ZA	2.95	1641	1.35
1L6	.79	6BQ6GT	1.15	12A6	.57	1N23	.68	434A	2.95	1654	1.75
1LA4	.79	6BQ7A	1.15	12A8GT	.79	1N23B	1.40	450TH	47.50	2050	.93
1LA6	.85	6C4	.38	12AH7GT	1.05	1N34	.42	450TL	35.00	2051	.65
1LB4	.85	6C5	.48	12AT6	.48	1N34A	.48	575A	9.95	5316	6.90
1LC5	.79	6C5GT	.46	12AT7	.92	2AP1	4.95	705A	.68	5317	1.65
1LC6	.79	6C6	.49	12AU6	.62	2C39A	12.45	707B	4.25	5637	4.95
1LD5	.85	6C8G	.85	12AU7	.75	2C40	7.45	714AY	35.00	5638	7.95
1LE3	.79	6C8B	.68	12AV7	.95	2C43	7.25	715C	10.95	5639	8.95
1LH4	.85	6D6	.59	12AX7	.78	2C51	2.95	717A	.35	5642	.95
1LN5	.79	6E5	.75	12AY7	1.15	2D21	.65	721A	.65	5651	1.35
1N5GT	.59	6F5	.59	12BA6	.60	2E22	3.45	726A	6.95	5654	1.25
1R4	.65	6F6	.85	12BA7	.89	2E24	1.95	725A	2.95	5657	1.45
1R5	.65	6F6GT	.69	12BE6	.65	2E26	2.95	723A/B	8.45	5675	10.95
1S4	.65	6F7	.85	12BH7	.89	2E30	1.95	726B	32.50	5686	2.45
1S5	.65	6F8G	.72	12C8	.69	2J32	12.50	726C	32.50	5687	2.65
1T4	.65	6G6G	.72	12H6	.59	2J36	14.95	750TL	39.50	5687	2.65
1T3GT	.69	6H6	.59	12J5GT	.65	2J51	97.50	801A	.38	5703	.95
1U4	.67	6H6GT	.49	12K7GT	.85	2J55	39.50	802	2.45	5763	.95
1U5	.59	6J5	.48	12K8	.69	2J61	12.95	803	1.40	5794	7.50
1V	.65	6J5GT	.47	12SA7	.69	2J62	4.45	804	8.85	5814	.98
1V2	.59	6J6	.68	12SA7GT	.69	2K25	11.95	805	3.95	5819	34.50
1V6	1.49	6J7	.82	12SC7	.75	2K28	27.50	806	4.85	5823	1.35
1X2A	.85	6J7GT	.65	12SG7	.79	2K33A	56.90	807	1.18	5851	3.45
2A3	.95	6K6GT	.65	12SH7	.65	3AP1	2.90	808	1.25	5876	12.50
2A5	.65	6K7	.74	12SJ7	.65	3B24	.95	809	2.20	5879	1.25
2A6	.59	6K7GT	.59	12SK7	.69	3BP1	2.45	810	9.90	5881	2.95
2X2	.49	6K8	1.10	12SL7	.85	3C22	59.50	811	2.75	5886	2.75
2X2A	1.35	6K8GT	.95	12SN7GT	.75	3C23	3.45	812	2.45	6146	4.75
3A4	.50	6L6	1.69	12SQ7	.59	3C24	1.48	813	10.10	8005	4.75
3A5	.64	6L6G	.98	12SR7	.59	3C45	5.95	814	1.50	8008	3.95
3B7	.39	6L7	.95	12V6GT	.73	3D21A	3.95	815	1.50	8012	.98
306	.39	6N7	.89	12W6GT	.87	3DP1	3.45	816	1.15	8013	2.65
3L74	.85	6Q7	.85	14A7	.75	3E29	8.45	826	.65	8014	67.50
3Q4	.65	6Q7GT	.79	14B6	.69	4-125A	18.95	828	7.42	8020	1.45
3Q3GT	.75	6R7	.85	15B6G6	1.89	4-250A	32.50	829B	7.95	8025	1.45
3S4	.65	6R7GT	.68	19T8	.95	4C27	3.25	830B	.65	9001	.82
3V4	.69	6S4	.57	25BQ6GT	1.25	4C28	17.45	832	5.75	9002	.60
5AW4	1.10	6SA7	.79	25L6GT	.65	4C35	13.45	832A	7.95	9003	.90
5R4GY	1.45	6SA7GT	.79	25W4GT	.72	4E27	7.95	833A	37.50	9004	.35
5T4	.90	6SB7Y	.87	25Z5	.75	4X150A	22.45	836	1.45	9005	1.39
5U4G	.58	6SC7	.72	25Z6	.62	5B12A	2.35	837	.88	9006	.25
5V4G	.88	6SF5	.72	30	.65	5B4A	1.95	838	.69	C1JA	10.95
5W4GT	.65	6SF5GT	.69	32L7GT	.85	5C22	27.50	845	4.85	C6J	6.45
5X4G	.75	6SG7	.65	35A5	.68	5CP1	7.95	851	8.95	CK1005	.32
5Y3GT	.49	6SH7	.74	35B5	.68	5CP7	7.95	860	2.75	CK1006	3.45
5Z3	.69	6SJ7	.69	35L6GT	.65	5O21	4.95	861	12.95	CK1007	.65
5Z4	.89	6SJ7GT	.59	35W4	.44	5FP7	1.37	866A	.98	F-123A	2.75
6A3	.95	6SK7	.64	35Y4	.65	5JP1	12.45	869B	14.95	F-127A	22.50
6A6	.82	6SK7GT	.59	35Z3	.65	5JP2	6.35	872A	1.25	F-128A	14.95
6A7	.89	6SL7GT	.75	35Z5GT	.44	5LP1	7.40	876	.72	FG-17	2.90
6A8	1.05	6SN7GT	.75	41	.75	5NP1	4.95	878	.48	FG-27	12.95
6A8GT	.95	6SQ7	.59	42	.69	6AN5	2.75	884	.95	FG-32	3.95
6A8A	.59	6SQ7GT	.59	43	.79	6A56	1.19	885	.95	FG-95	17.50
6A87	.95	6SR7	.55	50A5	.68	6A57G	2.35	902A	2.65	FG-105	12.95
6AC7	.85	6SS7	.75	50B5	.68	6C21	14.95	918	1.95	FG-172	17.95
6AF6G	.85	6ST7	.95	50C5	.68	6J4	2.55	923	1.25	HF-100	6.95
6AG5	.72	6T8	.95	50L6GT	.62	7BP7	4.95	927	.95	HF-200	9.95
6AG7	.98	6U5/6G5	.85	50Y6GT	.78	120P7	17.50	930	1.19	HF-300	17.50
6AH6	.85	6U8	.95	53	.92	15E	1.05	931A	2.45	WL-616	47.50
6AJ5	1.49	6V6	1.10	70L7GT	1.15	28D7	.75	954	.25	MX-408U	.50
6AK5	.69	6V6GT	.59	75	.65	100TH	6.25	955	.35	RK-65	7.50
6AK6	.75	6W4GT	.65	77	.47	211	.45	956	.35	RK-72	.50
6AL5	.58	6W6GT	.79	78	.57	212E	14.95	957	.35	RX-21	5.50
6AL7	.95	6X4	.48	80	.59	249C	1.95	958	.35	TZ-40	3.50
6AQ5	.57	6X5GT	.49	83	.95						
6AQ6	.57	6Y6G	.89	83V	.95						
6AT6	.52	7A4	.79	84/6Z4	.49						
6AU5GT	1.10	7A5	.69	117L/M7GT	2.25						
6AU6	.65	7A6	.78	117N/							
6AV6	.53	7A7	.75	P7GT	1.65						
6AX4GT	.79	7A8	.75	117Z3	.68						
6AX5GT	.69	7A7	.95	117Z6GT	.95						

**WRITE FOR OUR FREE FLYER**

TERMS: Cash with order or 25% deposit—balance C.O.D. 10% 30 days, net 30 days to rated accts. All prices net F.O.B.

# a **VOM** ... plus a **VTVM** when you need it. **DOUBLE USE... HALF THE PRICE**

**TRIPLETT MODEL 631**—In one year accepted as the  
 standard **COMBINATION VOM-VTVM**

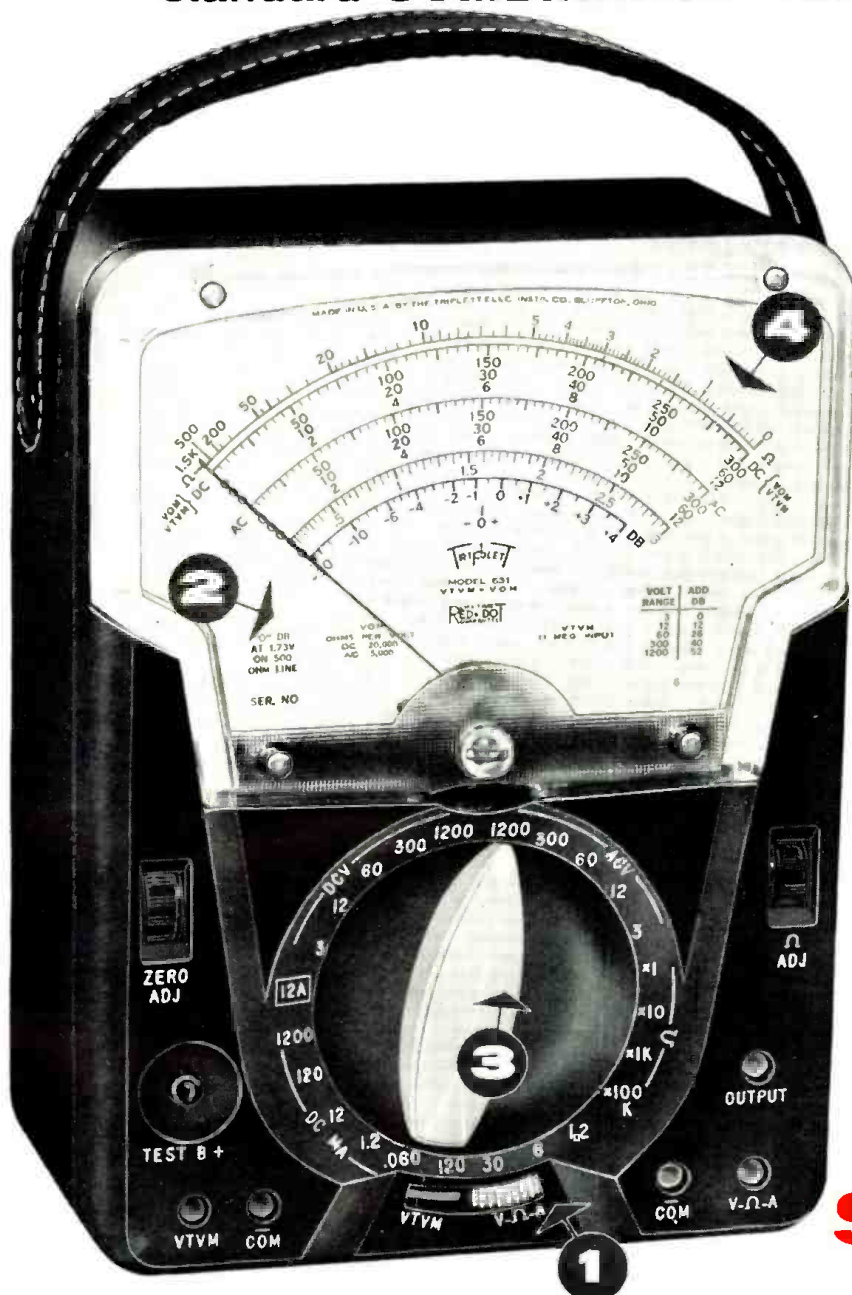

**Battery operated**

- 1** Just flip the switch.
- 2** Standard sensitivities as used in servicing manuals.
- 3** 34 ranges—with the famous Triplett single knob control.
- 4** Extra long scales —unobstructed visibility.

## **\$59.50**

By using the Volt-Ohm-Mil-Ammeter for all general testing (90% of your testing) and the Vacuum Tube Voltmeter only when you need it, you have the advantage of a VTVM with extremely long battery life. Batteries are used only about one-tenth as much as in the ordinary battery-operated VTVM. Features: Ohms, 0-1500-15,000 (6.8-68 center scale. First division is 0.1 ohm.)

Megohms: 0-1.5-150 (6,800-680,000 ohms center scale.) Galvanometer center mark "—0+" for discriminator alignment. RF Probe permits measurements up to 250 MC. \$7.00 net extra. Featured by leading electronic parts distributors everywhere.

# **TRIPLETT**

**TRIPLETT ELECTRICAL INSTRUMENT COMPANY • 52 years of experience • BLUFFTON, OHIO**

*Triplett design and development facilities are available for your special requirements for meters and test equipment.*

... another  
**MALLORY**  
service-engineered  
product



Control  
Replacements  
are speedy  
and sure...  
*with*

## Midgetrols<sup>®</sup>

You'll like Mallory Midgetrols . . . for the way they save your time. Need a line switch? You can attach it instantly, without taking the control apart. Need a tailor-made shaft? In seconds you can cut the round, tubular shaft and insert a split-knurl or flatted tip.

**Your customers will like their performance.** The extra-smooth surfaced carbon element, manufactured by a special Mallory process, assures long life and noise-free operation.

See your local Mallory distributor. He's ready to supply you with Midgetrols in the exact resistance values and tapers to fit all popular TV and radio sets.

P. R. MALLORY & CO. Inc.  
**MALLORY**

P. R. MALLORY & CO. Inc., INDIANAPOLIS 6, INDIANA

• Capacitors • Vibrators • Resistors • Controls • Switches  
• Rectifiers • Power Supplies • Filters • Mercury Batteries